

BA 33.0003
00492660

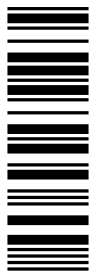

Operating Instructions

Motors

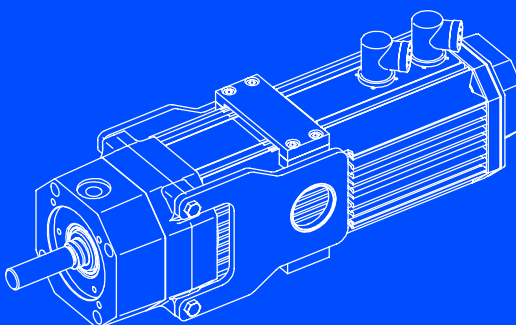

MDSL servo spindle motors

Structure of type code for servo spindle motors

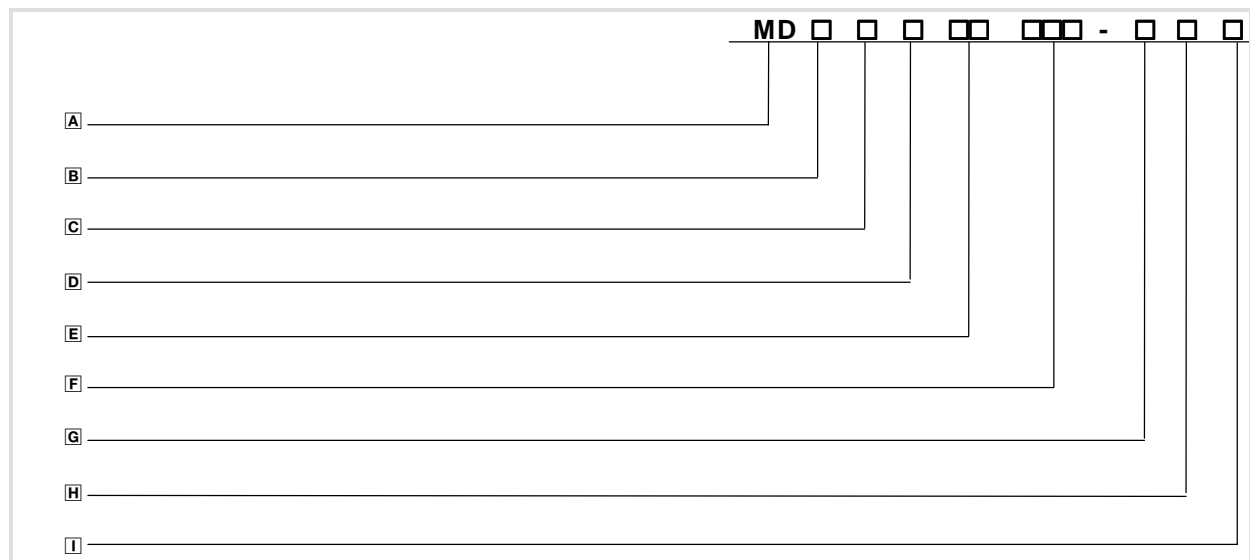

A	Current type	D = three-phase current
B	Cooling type/ventilation	S = Self-cooled (cooling via convection and radiation)
C	Design/housing	L = Compact servo motor with integrated linear feed
D	Machine type	S = Synchronous machine
E	Built-on accessories	AG = Absolute value encoder BA = Brake and SinCos absolute value encoder or SSI absolute value encoder BG = Brake, resolver and incremental encoder BI = Brake and incremental encoder (pulse encoder) BR = Brake BS = Brake and resolver BW = Brake, resolver and absolute value encoder BX = Brake, encoder prepared GX = No brake, encoder prepared NN = No brake, no encoder IG = Incremental encoder (pulse encoder) RA = Resolver and absolute value encoder RI = Resolver and incremental encoder RS = Resolver
F	Frame size	
G	Overall length	
H	Number of pole pairs	
I	Specification	" " = Standard "U" = UL design, UR certificate

Nameplate of servo spindle motor

Lenze		Hans-Lenze-Strasse 1 D-31855 Aerzen http://www.Lenze.com		CE Made in Germany	
① 3~MOT	Typ ②				
⑬ V~	⑰	⑭ Nm	⑦ Hz	⑧ 1/min	
⑥ A	⑫ kW	Mo ⑨ Nm	⑳	C86: ⑲	
max A	IP ④	I.CL. ⑤	Ta 40°C		⑮
Geber Feedback ⑰		C416:		Id.Nr. ③	
Bremse Brake ⑯	⑰ V-	A Nm	FN ⑳ kN	㉓ / ㉒ mm	
SN ⑱					

No.	Explanation	No.	Explanation
1	Motor type: three-phase AC motor	13	Rated voltage U_N [V]
2	Lenze motor type	14	Rated torque M_N [Nm]
3	ID no.	15	Labelling of thermal detector
4	Enclosure	16	Data for holding brake: voltage, current, torque
5	Thermal class	17	Labelling of encoder 1)
6	Rated current I_N [A]	18	Motor no.
7	Rated frequency f_N [Hz]	19	Selection number for operation at servo inverters of series 9300 2)
8	Rated speed n_N [min ⁻¹]	21	Rated load
9	Continuous standstill torque M_0 [Nm]	22	Lead
12	Rated power P_N [kW]	23	Lift

- 1) RS1 - Lenze-specific resolver (1 pair of poles)
RS3 - KUKA-specific resolver (3 pairs of poles)

- 2) For operation with servo inverters of series 9300:

In C0086 or GDC (Global Drive Control software), enter the specified selection number to automatically optimise the control mode.

What is new / what has changed in the Operating Instructions?

Material number	Edition	Important	Contents
00 492 660	1.0 04/04 TD09	1st edition	First printing

© 2004 Lenze Drive Systems GmbH, Hans-Lenze-Straße 1, 31855 Aerzen

No part of this documentation may be reproduced or made accessible to third parties without written consent by Lenze Drive Systems GmbH.

All information given in this documentation has been selected carefully and complies with the hardware and software described. Nevertheless, deviations cannot be ruled out. We do not take any responsibility or liability for damages which might possibly occur. Necessary corrections will be included in subsequent editions.

1 Preface and general information

Scope of supply

1 Preface and general information

1.1 About these Operating Instructions

- ▶ The present operating instructions are intended for safe working on and with servo spindle motors of type MDSLS. They contain safety instructions that must be observed.
- ▶ All personnel working at and with the servo spindle motors listed must have the operating instructions available and observe the information and notes important for them.
- ▶ The operating instructions must always be complete and perfectly readable.
- ▶ If the information in these operating instructions is not sufficient for your case, please consult the operating instructions of the drive controllers.

1.2 Terminology used

Term	Used in the following text for
Motor	Servo spindle motor type MDSLS
Drive controller	Any servo inverter of series 9300, ECS
Drive system	Servo inverter with servo spindle motor and other Lenze drive components

1.3 Scope of supply

The drive systems are individually grouped. After receipt of the supply, check immediately whether it corresponds with the accompanying papers. Lenze does not grant any warranty for subsequent claims.

Claim for

- ▶ visible transport damages immediately to the forwarder.
- ▶ visible deficiencies / incomplete deliveries immediately to your Lenze representative.

1.4 Legal regulations

Labelling	Nameplate Lenze motors are uniquely designated by the content of the nameplate.	CE designation Conforming to EC "Low-Voltage Directive"	Manufacturer Lenze Drive Systems GmbH Postfach 10 13 52 D-31763 Hameln
Application as directed	<p>Servo spindle motors type MDSLS</p> <ul style="list-style-type: none"> ● must only be operated under the operating conditions prescribed in these instructions. ● are components: <ul style="list-style-type: none"> – for use as small drives. – for installation in a machine. – for assembly with other components into a machine. ● meet the protection requirements of the EC "Low-Voltage Directive". ● are not machines in the sense of the EC Machine Directive. ● are not household appliances, but as components solely intended for further application for commercial use. <p>Drive systems with servo spindle motor type MDSLS</p> <ul style="list-style-type: none"> ● meet the EC Directive "Electromagnetic compatibility" if they are installed according to the specifications of the CE-typical drive system. ● are applicable: <ul style="list-style-type: none"> – in public and non-public mains. – in industrial as well as residential areas. ● The end user is responsible for adhering to the EC directives in the machine application. <p>Any other use is considered unintended!</p>		
Liability	<ul style="list-style-type: none"> ● The information, data, and notes in these instructions were state of the art at the time of printing. Claims referring to motors which have already been supplied cannot be derived from the information, illustrations, and descriptions. ● The process-related notes and circuit sections used in these instructions are suggestions whose suitability for the respective application must be checked. Lenze assumes no guarantee for the suitability of the listed procedures and circuit samples. ● The information in these instructions describes the features of the products without assuring them. ● No liability is accepted for damages and malfunctions caused by: <ul style="list-style-type: none"> – disregarding the operating instructions – unauthorised modifications to the motors – operating mistakes – improper working at and with the motors. 		
Warranty	<ul style="list-style-type: none"> ● Conditions of warranty: see terms of sale and delivery of Lenze Drive Systems GmbH. ● Warranty claims must be made to Lenze immediately after detecting the deficiency or fault. ● The warranty is void where liability claims cannot be made. 		
Disposal	Material	Recycle	Dispose
	Metal	●	-
	Plastic	●	-
	Assembled PCBs	-	●

(to: Low-Voltage Directive 73/23/EEC)

General

Low-voltage machines have dangerous, live and rotating parts as well as possibly hot surfaces. All operations serving transport, connection, commissioning and maintenance are to be carried out by qualified, skilled personnel (observe EN 50110-1 (VDE 0105-100); IEC 60364). Improper handling may cause severe injury to persons or damage to material assets.

Synchronous machines induce voltages at open terminals during operation.

Application as directed

These low-voltage machines are intended for industrial and commercial installations. They comply with the harmonized standards of the EN 60034 (VDE O530) series. Their use in hazardous areas is prohibited unless they are expressly intended for such use (follow additional instructions).

Degrees of protection \leq IP23 are only intended for outdoor use when applying special protective measures. Air-cooled designs are rated for ambient temperatures from -15 °C and -10 °C to $+40\text{ °C}$ and altitudes \leq 1000 m a.m.s.l., from -20 °C to $+40\text{ °C}$ without brake or with spring-operated brake, non-ventilated or with integral fan, from -15 °C to $+40\text{ °C}$ with permanent magnet brake and from -10 °C to $+40\text{ °C}$ with separate fan. Check indications on the nameplate and if they are different, observe them. The conditions on site must correspond to all nameplate data.

Low-voltage machines are components for the installation into machines as defined in the Machinery Directive 98/37/EC. Commissioning is prohibited until the conformity of the end product with this Directive has been established (follow a.o. EN 60204-1).

The integrated brakes cannot be used as safety brakes. It cannot be guaranteed that factors which cannot be influenced, such as oil ingress because of a defective A-side shaft seal, do not cause a torque reduction.

Transport, storage

The forwarder must be informed directly after receipt of the goods about all damages or deficiencies; if necessary, commissioning must be stopped. Tighten screwed-in ring bolts before transport. They are designed for the weight of the low-voltage machine, do not apply extra loads. If necessary, use suitable and adequately dimensioned means of transport (e.g. rope guides).

Remove the shipping braces before commissioning. Reuse them for further transports. For storage of low-voltage machines ensure a dry, dust-free and low-vibration ($v_{\text{rms}} \leq 0.2\text{ mm/s}$) environment (damage while being stored). Measure the insulation resistance before commissioning. If the values are \leq 1 k Ω per volt of rated voltage, dry the winding.

Installation

Ensure an even surface, solid foot or flange mounting and exact alignment if a direct clutch is connected. Avoid resonances with the rotational frequency and double mains frequency which may be caused during assembly. Turn rotor by hand, listen for unusual slipping noises. Check the direction of rotation when the clutch is not active (observe section 5).

Use appropriate tools to mount or remove belt pulleys and clutches (heat generation!) and cover them with a touch guard. Impermissible belt tensions must be avoided (technical list).

The machines are half-key balanced. The clutch must be half-key balanced, too. The visible outstanding part of the key must be removed.

If required, provide pipe connections. Designs with shaft end at bottom must be protected with a cover which prevents the ingress of foreign particles into the fan. Free circulation of the cooling air must be ensured. The exhaust air - also the exhaust air of other machines next to the drive system - must not be taken in again immediately.

Electrical connection

All operations must only be carried out by qualified and skilled personnel when the low-voltage machine is at standstill and when the machine is de-energized and protected against unintentional restart. This also applies to auxiliary circuits (e.g. brake, encoder, separate fan).

Check safe isolation from the supply!

If the tolerances in EN 60034-1; IEC 34 (VDE 0530-1) - voltage $\pm 5\%$, frequency $\pm 2\%$, wave form, symmetry - are exceeded, more heat will be generated and the electromagnetic compatibility will be influenced.

Observe the indications on the nameplate, operating notes, and the connection diagram in the terminal box.

The connection must ensure a continuous and safe electrical supply (no loose wire ends); use appropriate cable terminals. The connection to the PE conductor must be safe. The plug-in connector must be bolted tightly (to stop).

The clearances between blank, live parts and earth must not fall below 8 mm at $V_r \leq 550$ V, 10 mm at $V_r \leq 725$ V, 14 mm at $V_r \leq 1000$ V.

The terminal box must be clean and dry; foreign particles, dirt and moisture disturb operation. All unused cable entries and the box itself must be sealed against dust and water. For the trial run without output elements, lock the key. Check brake operation before commissioning of low-voltage machines with brakes.

Operation

Vibration severities $v_{rms} \leq 3.5$ mm/s ($P_r \leq 15$ kW) and 4.5 mm/s ($P_r > 15$ kW) are acceptable when the clutch is activated. If deviations from normal operation occur, e.g. increased temperatures, noises, vibrations, find the cause and, if necessary, contact the manufacturer. Switch off the machine in problematic situations.

If the drive is exposed to dirt, clean it regularly.

Do not switch off the protection devices, not even for trial runs.

Integrated temperature sensors do not provide full protection. If necessary, limit the maximum current. Connect the function blocks such that the machine switches off after several seconds of operation at $I > I_r$, especially if blocking may occur.

Shaft seals and bearings have a limited service life.

Regrease the bearings using the relubrication facility while the low-voltage machine is running. Observe the saponification number. If the grease drain hole is sealed with a plug (IP54 driven end; IP23 driven end and non-driven end), remove the plug before commissioning. Seal the bore holes with grease. Replace the prelubricated bearings (2Z bearings) after approx. 10,000 h - 20,000 h, at the latest however after 3 - 4 years. Observe the manufacturer's instructions.

2.2**General safety and application notes for Lenze controllers**

(to: Low-Voltage Directive 73/23/EEC)

General

Depending on their degree of protection, some parts of Lenze controllers (frequency inverters, servo inverters, DC controllers) and their accessory components can be live, moving and rotating during operation. Surfaces can be hot.

Non-authorized removal of the required cover, inappropriate use, incorrect installation or operation, creates the risk of severe injury to persons or damage to material assets.

For more information please see the documentation.

All operations concerning transport, installation, and commissioning as well as maintenance must be carried out by qualified, skilled personnel (IEC 364 and CENELEC HD 384 or DIN VDE 0100 and IEC report 664 or DIN VDE 0110 and national regulations for the prevention of accidents must be observed).

According to this basic safety information, qualified, skilled personnel are persons who are familiar with the assembly, installation, commissioning, and operation of the product and who have the qualifications necessary for their occupation.

Application as directed

Drive controllers are components which are designed for the installation into electrical systems or machinery. They are not to be used as domestic appliances, but only for industrial purposes according to EN 61000-3-2. The documentation contains information about the compliance with the limit values to EN 61000-3-2.

When installing drive controllers into machines, commissioning of these controllers (i.e. the starting of operation as directed) is prohibited until it is proven that the machine corresponds to the regulations of the EC Directive 98/37/EC (Machinery Directive); EN 60204 must be observed.

Commissioning (i.e. starting of operation as directed) is only allowed when there is compliance with the EMC Directive (89/336/EEC).

The drive controllers meet the requirements of the Low-Voltage Directive 73/23/EEC. The harmonised standards of the EN 50178/DIN VDE 0160 series apply to the controllers.

The technical data as well as the connection conditions can be obtained from the nameplate and the documentation. They must be strictly observed.

Warning: Drive controllers are products with restricted availability according to EN 61800-3. These products can cause interferences in residential premises. If controllers are used in residential premises, corresponding measures are required.

Transport, storage

The notes on transport, storage and appropriate handling must be observed.

The climatic conditions according to EN 50178 must be observed.

Installation

The controllers must be installed and cooled according to the regulations given in the corresponding documentation.

Ensure careful handling and avoid mechanical overload. Do not bend any components and do not change the insulation distances during transport and handling. Electronic components and contacts must not be touched.

Drive controllers contain electrostatically sensitive components which can easily be damaged by inappropriate handling. Do not damage or destroy any electrical components since this could mean hazards to your health!

Electrical connection

When working on live drive controllers, the valid national regulations for the prevention of accidents (e.g. VBG 4) must be observed.

Carry out the electrical installation in compliance with the corresponding regulations (e.g. cable cross-sections, fuses, PE connection). More detailed information is given in the corresponding documentation.

Notes about wiring according to EMC regulations (shielding, earthing, filters and cable routing) are included in the documentation. These notes also apply to CE-marked controllers. The compliance with limit values required by the EMC legislation is the responsibility of the manufacturer of the machine or system.

In the case of a malfunction (short circuit to frame or earth fault), Lenze controllers can cause a DC residual current in the protective conductor. If an earth-leakage circuit breaker (residual current device) is used as a protective means in the case of direct or indirect contact, only an e.l.c.b. of type B may be used on the current supply side. Otherwise, another protective measure such as separation from the environment through double or reinforced insulation or disconnection from the mains by means of a transformer must be used.

Operation

If necessary, systems including controllers must be equipped with additional monitoring and protection devices according to the valid safety regulations (e.g. law on technical equipment, regulations for the prevention of accidents). The controller can be adapted to your application. Please observe the corresponding information given in the documentation.

After a controller has been disconnected from the voltage supply, all live components and power connections must not be touched immediately because capacitors can still be charged. Please observe the corresponding stickers on the controller.

All protection covers and doors must be shut during operation.

Note for UL approved systems with integrated controllers: UL warnings are notes that only apply to UL systems. The documentation contains special UL notes.

Safe standstill

The V004 variant of the 9300 and 9300 vector controllers, the x4x variant of the 8200 vector controllers and the ECSxAxxx axis modules support the "safe standstill" function, protection against unexpected start-up, according to the requirements of Annex I No. 1.2.7 of the EC Directive "Machinery" 98/37/EC, DIN EN 954-1 Category 3 and DIN EN 1037. Observe the notes on the "safe standstill" function given in the documentation on the respective variants.

Maintenance and servicing

The drive controllers are maintenance-free when the specified operating conditions are met.

If the ambient air is polluted, the cooling surfaces of the controller may become dirty or the air vents of the controller may be obstructed. Therefore, clean the cooling surfaces and air vents periodically under these operating conditions. Do not use sharp or pointed tools for this purpose!

Waste disposal

Recycle metal and plastic materials. Ensure professional disposal of assembled PCBs.

The product-specific safety and application notes given in these instructions must be observed!

2.3 Residual hazards

Protection of persons	<p>The motor surfaces can become very hot. Danger of burns when touching!</p> <ul style="list-style-type: none"> ● Install a guard, if necessary. <p>High-frequency voltages can be capacitively transferred to the motor housing through the inverter supply.</p> <ul style="list-style-type: none"> ● Carefully earth the motor housing. <p>Danger of unintentional starting or electrical shocks</p> <ul style="list-style-type: none"> ● Perform connection work only in the de-energised state, only with motor in standstill. ● Built-in brakes are not fail-safe brakes.
Device protection	<p>Built-in thermal detectors are not a full protection for the machine.</p> <ul style="list-style-type: none"> ● If necessary, limit the maximum current, perform a function block interconnection with disconnection after a few seconds of operation with $I > I_N$, particularly if a danger of blocking exists. ● The integrated overload protection does not prevent overload under all conditions! <p>Built-in brakes are not fail-safe brakes.</p> <ul style="list-style-type: none"> ● Speed reduction is possible. <p>Fuses are not a motor protection.</p> <ul style="list-style-type: none"> ● Use current-dependent motor protection switches for average operating frequency ● Use built-in thermal detectors at high operating frequency. <p>Excessive torques lead to a break of the motor shaft or demagnetisation</p> <ul style="list-style-type: none"> ● Do not exceed the maximum torques according to the catalogue. <p>Lateral forces from the motor shaft are possible.</p> <ul style="list-style-type: none"> ● Perfectly align shafts of motor and driving machine to each other. ● Speeds $> 3000 \text{ min}^{-1}$ destroy the motor.
Fire protection	<p>Fire hazard</p> <ul style="list-style-type: none"> ● Prevent contact with combustible substances.

2.4 Definition of notes used

The following signal words and symbols are used in this documentation to indicate dangers and important information:

Safety instructions

Structure of safety instructions:





Pictograph and signal word!



(identify the type and severity of the danger)

Note

(describes the danger and gives information about how to prevent dangerous situations)

Pictograph and signal word	Meaning
 Danger!	Danger of personal injury through dangerous electrical voltage. Reference to an imminent danger that may result death or serious personal injury if the corresponding measures are not taken.
 Danger!	Danger of personal injury through a general source of danger Reference to an imminent danger that may result in death or serious personal injury if the corresponding measures are not taken.
 Stop!	Danger of property damage. Reference to a possible danger that may result in property damage if the corresponding measures are not taken.

Application notes

Pictograph and signal word	Meaning
 Note!	Important note about trouble-free operation
 Tip!	Useful tip for simple handling
	Reference to another documentation

3 Technical data

3.1 General data/operating conditions

Range	Values	
Mounting positions	Can be used in all mounting positions	Vertical arrangements to DIN-IEC 34 Part 7 are possible if they meet the designs
Enclosure	See nameplate	Enclosures apply only to horizontal installation
Thermal class	F (155 °C) to DIN-IEC 34 / VDE 0530	Exceeding the temperature limit weakens or destroys the insulation
Tropical protection	Not guaranteed	
Permissible temperature range	Versions	
	<ul style="list-style-type: none"> Non-ventilated without or with spring-operated brake 	-20 °C ... +40 °C Without power reduction
Permissible installation height h	h ≤ 1000 m AMSL 1000 m AMSL < h ≤ 2000 m AMSL	Without power reduction With power reduction
Certifications	CE Low-Voltage Directive	
Permissible voltage load	1.5 kV peak value	5 kV/μs rate of rise
Humidity	Up to 85% without moisture condensation	
Vibration	Up to 2.0 g, if no resonances are excited, e.g. the fan.	

3.2

Rated data

**Note!**

- ▶ The listed values apply for operation with Lenze servo inverters 9300 or ECS:
 - Operation at 400-V mains
 - Switching frequency 4 kHz, 8 kHz or 16 kHz.
- ▶ For operation with other servo inverters:
 - Do not fall below 4-kHz switching frequency.
 - Depending on the modulation and control mode of the servo inverter, the temperature monitoring may respond. In this case, reduce power!

Rated data	Motor		Comment
	MDSLBS056-33	MDSLBS071-13	
Current, connection voltage, power	See nameplate		
Rated speed [min ⁻¹]	3000		
Maximum speed [min ⁻¹]	3000		Higher speeds destroy the motor
Rated torque [Nm]	4.2	8.3	
Maximum torque [Nm]	17.2	35.2	Excessive torques lead to spindle break or demagnetisation
Max. axial force [kN] at 0 min ⁻¹	10	15	Excessive forces shorten the service life.
Radial force [N]	maximum ≤ 1 % F _N		
Weight with brake [kg]	13.5	21	
Linear drive			
Lift [mm]	160	170	
Traversing speed [mm/s]	250		
Travel tolerance [mm]	0.2		
Spindle			
Lead [mm]	5		
Diameter [mm]	20	25	
Connection (A-side)	M16 x 1.5; Thread length 60 mm	M20 x 1.5; Thread length 60 mm	
Spindle type	Ball-and-screw spindle		
Initial stress	---		
Protection against torsion	By installing the drive in the tool, i.e. no locking element in the motor		
Lubrication	Grease chamber in the motor, filling via external grease supply		
Sound pressure level			
Sound pressure [db (A)]	< 70		Sound pressure level, A-analysed Distance = 1 m Motor in no-load operation, U = 3000 min ⁻¹
Fan operation			Operation with servo inverter 9300 Switching frequency 4 kHz, 8 kHz or 16 kHz

3.3 Holding brake (option)

The MDXLS servo motors can optionally be fitted with a spring-operated brake.

The brakes used are not fail-safe brakes in the sense that a torque reduction cannot occur through uncontrollable interference factors, such as through the entrance of oil.

With long motor supply cables, the ohmic voltage drop along the cable must be observed and compensated for by a higher voltage at the cable entry.

The following applies to Lenze system cables:

$$U^* [V] = U_B [V] + \left(0.08 \left[\frac{V}{m \cdot A} \right] \cdot L [m] \cdot I_B [A] \right)$$

U*	Resulting supply voltage
U _B	Rated voltage of the brake
L	Length of cable
I _B	Rated current of the brake



Stop!

If no suitable voltage (incorrect size, incorrect polarity) is applied to the brake, the brake is applied and can overheat and be destroyed by the motor which continues to run.

The shortest operating times of the brakes are achieved by switching the voltage on the DC side and a suppressor circuit (varistor or spark suppressor). Without suppressor circuit, the operating times may increase. A varistor/spark suppressor limits the breaking voltage peaks. It must be observed that the power limit of the suppressor circuit is not exceeded. It is dependent on the brake current, brake voltage, disengagement time and the switchings per time unit.

The suppressor circuit is also required for radio interference suppression and for increasing the service life of the relay contacts (external, not integrated in the motor).

3.3.1 Spring-operated brakes

The spring-operated brakes can be used as holding and/or service brakes. If used as service brake, the permissible friction energy must not be exceeded; otherwise it would destroy the brake. Permissible operating speeds and ratings  Spring-operated brakes catalogue. Emergency stops from a higher speed are possible, but wear increases with high switching energy.

**Stop!**

In any case, the friction surfaces must be kept free of lubricant and grease, since even small amounts can drastically reduce the braking torque.

The use as a pure holding brake results in only minor wear at the friction surfaces. Emergency stops or the use as service brake creates wear at the friction surfaces, and the abrasion of the wear parts creates dust. The Lenze spring-operated brake BFK 458 can be adjusted up to 5 times, while the BFK 418, 457 and 460 cannot be adjusted (for details  catalogues and operating instructions of spring-operated brakes). Brakes, which cannot be adjusted, must be replaced after reaching the wear limit.

The friction energy per switching cycle is calculated as:

$Q = \frac{1}{2} \cdot J_{total} \cdot \Delta\omega^2 \cdot \frac{M_K}{M_K - M_L}$	Q [J]	Friction energy
	J_{total} [kgm ²]	Total mass moment of inertia (motor + load)
	$\Delta\omega$	Angular speed $\omega=2\pi \cdot n/60$, n= speed [min ⁻¹]
	M_K [Nm]	Characteristic torque
	M_L [Nm]	Load torque

and must not exceed the limit value, which is dependent on the operating frequency, for braking during operation and also for emergency stops ( Spring-operated brake catalogue).

Depending on the operating conditions and possible heat removal, the surface temperatures can reach up to 130 °C.

The spring-operated brakes operate according to the closed-circuit principle, i.e. the brake is closed in the de-energized state. The brakes can be fed with a bridged DC voltage (bridge rectifier) and a smooth DC voltage. The permissible voltage tolerance is ±10%.

**Note!**

For additional information see the catalogues and operating instructions of spring-operated brakes.

4 Mechanical installation

4.1 Transport, storage and installation

Transport	<ul style="list-style-type: none"> ● Transport motors only with sufficiently loadable means of transport or hoists. <ul style="list-style-type: none"> – Ensure secure fastening: The motors are partially equipped with transport eyelets that are intended for secure fastening to hoists. They are only designed for the weight of the motor and must not be used if other components are mounted to the motor (weights: see catalogue). ● Transport motors free of vibration. ● Avoid strong shocks and impacts.
Storage location	<ul style="list-style-type: none"> ● Vibration-free <ul style="list-style-type: none"> – If vibrations cannot be ruled out: Turn rotor once every week at the storage site. ● Dry without aggressive atmosphere ● Dust-free ● Without sudden temperature changes ● In the delivery state, all steel components have corrosion protection. Do not remove the protection! Check every three months and replace, if necessary.
Installation	<ul style="list-style-type: none"> ● Provide for a mounting option that corresponds to the design, weight and torque of the motor. ● Before mounting the motor, place base and flange surfaces evenly. <ul style="list-style-type: none"> – Insufficient motor alignment shortens the service life of the roller bearings and the transmission elements. ● Attach couplings and other transmission elements only according to instructions. <ul style="list-style-type: none"> – Impacts on shafts can cause bearing damage (▢ Ch. 4.2). ● Do not exceed the permissible range of ambient operating temperature (▢ Ch. 3.1). ● Humidity ≤85%, non-condensing ● Vibration ≤2g without resonance excitation ● Securely mount the motor. ● Ensure that ventilation is unobstructed. ● During operation, surfaces are hot, up to 140 °C! Ensure that guard is in place!

4.2 Assembly of built-on accessories

You must proceed according to the following instructions. Note that you will lose all warranty rights in case of unauthorised conversions or modifications, and product liability will be excluded.

- ▶ For new motors, you may have to remove the corrosion protection from the shaft ends and flanges. In this case, ensure that no solvent enters the bearings!
- ▶ Mount the transmission elements:
 - Shocks and impacts must be avoided! They could destroy the motor.
- ▶ Protect spindle against contamination by using a gaiter.
 - Dust-proof design
- ▶ Install the external lubricating equipment. The lubricating channel must be filled with grease to the motor!

4.3 Connection of external lubricant unit

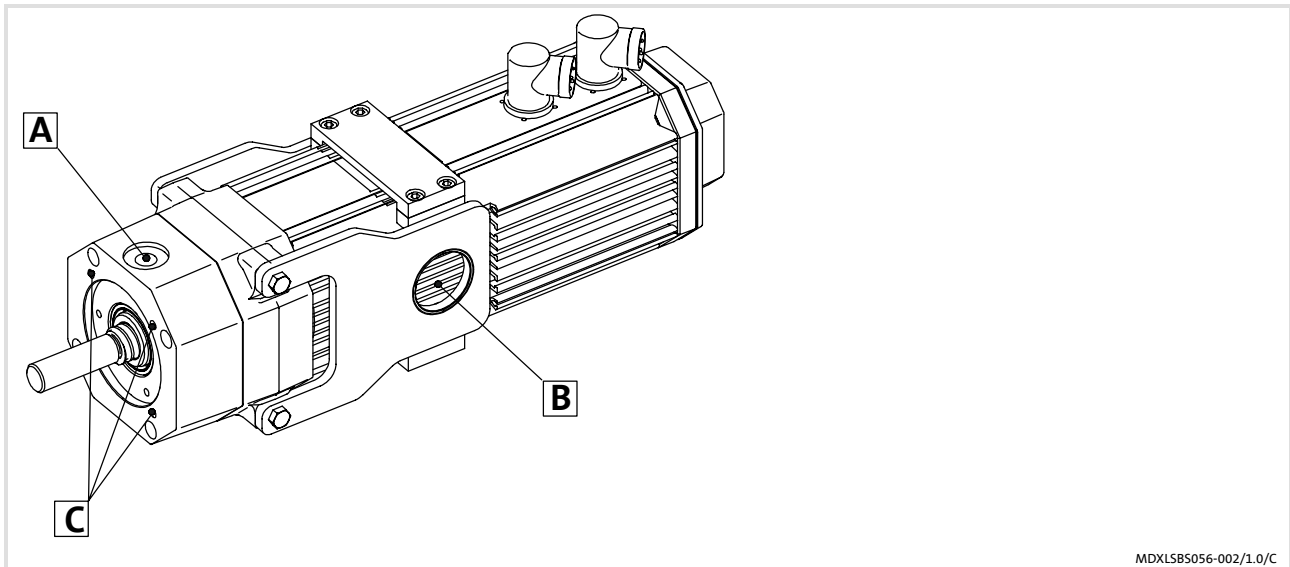

Fig. 1 MDSLBS056

- A** Connection of grease unit via grease nipple
 - Grease nipple connection: pipe thread ISO228-G 1/4"; thread depth 12 mm
- B** Pin support $\varnothing 35$ mm
- C** Threaded holes for B14 design

Lenze recommends the lubrication units from the following manufacturers, among others:

Manufacturer	Type	Design
Perma-tec GmbH, Euersdorf	perma - STAR	Vario or Control

or

similar systems with a grease delivery rate of $2 \text{ cm}^3 / \text{month}$.

The servo spindle motors from Lenze are operational at delivery and filled with a drive-specific lubricant filling. This initial filling uses the lubricant:



Stabutherm GH 461



Stop!

- ▶ If another grease must be used, the grease compatibility must be ensured!
- ▶ The grease channel must be filled with lubricant from the permanent lubricating equipment to the inside of the motor! If necessary, before extracting.



Note!

Please note that the recommendation of a lubricant/grease does not mean that Lenze is liable for these lubricants or damages resulting from incompatibilities of materials used.

4.4 Motor support

See Ch. 4.3



Stop!

When installing the motor using the intended support, ensure that the bolt being inserted in the support is completely seated.

- ▶ MDSLS056: Bolt \varnothing 35mm
Depth of seat 6 mm
- ▶ MDSLS071: Bolt \varnothing 35mm
Depth of seat 8 mm

Alternatively, the motors can be mounted using the fixing holes in the A-end shield in the tool/system (B14 mounting).

- ▶ MDSLS056: Pitch circle \varnothing 80 mm; M6
- ▶ MDSLS071: Pitch circle \varnothing 130 mm; M8

4.5 Bellows

To protect the spindle from dirt, it must be covered with dust-proof bellows.



Note!

The bellows selection must consider the maximum occurring surface temperature of the motor!

5 Electrical installation

Important notes

5 Electrical installation

5.1 Important notes



Danger!

Hazardous voltage at the power terminals, even if the plug is removed:
residual voltage > 60 V!

Before working at the power terminals, disconnect the drive controller from the mains and wait until the motor stands still (voltage at the contact while the motor is turning).

General		<ul style="list-style-type: none"> ● Observe the notes in the terminal box of the motor. ● Firmly tighten all connections. ● Connect PE connector to earthing screw. ● Fit connecting cable with strain relief. ● Carefully earth the motor.
Voltage supply	Servo spindle motors	<ul style="list-style-type: none"> ● Servo spindle motors must be fed by servo inverters. ● Connect the integrated encoder at the motor side with the corresponding connections of the servo inverter.
	Holding brake (optional)	<ul style="list-style-type: none"> ● DC supply according to nameplate data of the brake or supply with AC voltage via upstream rectifier (only spring-operated brake, PM brakes 205 V)¹⁾ ● Brakes for 205 V can be fed from the 230 V mains via bridge rectifiers, brakes for 103 V from the 115 V mains. ● Do not supply brakes with half-wave rectifiers from the AC system.
Inverter operation		<ul style="list-style-type: none"> ● Observe the connection notes in the corresponding operating instructions. ● Ensure that motor and inverter are correctly assigned. ● In particular, observe the speed limits and winding load. *
Cable cross sections		<ul style="list-style-type: none"> ● Correctly dimension the connecting cables to avoid impermissible heating. ● Maintain minimum cross sections to DIN 57100 and secure appropriately (see Tab. 1).
Motor protection	Protection against overload	<ul style="list-style-type: none"> ● Common current-dependent motor protection switches for average operating frequency <ul style="list-style-type: none"> – Set to rated current as indicated on the nameplate. ● With very high operating frequency: Use three-phase AC motors from Lenze with thermal switches or PTC thermistors in the winding. <ul style="list-style-type: none"> – The thermal switches are integrated in the winding as NO contact or NC contact. The response temperature is permanently set.
	Motor supply cable	<ul style="list-style-type: none"> ● No protection possible via overtemperature protector switches or PTC thermistors of the motor winding <ul style="list-style-type: none"> – Take measures according to DIN 57100 / VDE 0530.
	Inverter operation	<ul style="list-style-type: none"> ● The current or voltage conversion can increase the output current significantly above the input current. <ul style="list-style-type: none"> – The motor supply cable cannot be fused via the mains input fuses of the inverter. Take measures according to DIN 57100 / VDE 0530.

1) Supply PM brakes for 24 VDC only with smooth DC voltage (ripple ≤1%)

* Voltage limits: 1.5 kV peak value, 5 kV/μs rate of rise; additional information: see the data sheet.

Rated cross section q [mm ²]	Ampacity of insulated cables by protective devices ¹⁾ (DIN 57100 / VDE 0100 T 523)												
	Group 1 ²⁾				Group 2 ³⁾				Group 3 ⁴⁾				
	Cable		Protective device ⁵⁾		Cable		Protective device ⁵⁾		Cable		Protective device ⁵⁾		
	I _N [A]		I _N [A]		I _N [A]		I _N [A]		I _N [A]		I _N [A]		
	Cu	Al	Cu	Al	Cu	Al	Cu	Al	Cu	Al	Cu	Al	
0,75	–	–	–	–	12	–	6	–	15	–	10	–	
1,0	11	–	6	–	15	–	10	–	19	–	10	–	
1,5	15	–	10	–	18	–	10	–	24	–	20	–	
20	20	15	16	10	26	20	20	16	32	26	25	20	
25	25	20	20	16	34	27	25	20	42	33	35	25	
33	33	26	25	20	44	35	35	25	54	42	50	35	
45	45	36	35	25	61	48	50	35	73	57	63	50	
61	61	48	50	35	82	64	63	50	98	77	80	63	
83	83	65	63	50	108	85	80	63	129	103	100	80	
35	103	81	80	63	135	105	100	80	158	124	125	100	
50	132	103	100	80	168	132	125	100	198	155	160	125	
70	165	–	125	–	207	163	160	125	245	193	200	160	
95	197	–	160	–	250	197	200	160	292	230	250	200	
120	235	–	200	–	292	230	250	200	344	268	315	200	
150	–	–	–	–	335	263	250	200	391	310	315	250	

Tab. 1 Ampacity; maximum ambient temperature: 30 °C

- 1) With adjustable protective devices (motor protection switch, circuit breaker). Adjust the device to the rated cable current. Select cable circuit breaker according to DIN 57641 / VDE 0641 / CEE 19 and protective cable fuses according to DIN 57636 / VDE 0636 in accordance with the table.
- 2) One or several single-core cables installed in a pipe
- 3) Multi-core cables, e.g. plastic-sheathed cables, hardmetal-sheathed cables, lead-sheathed cables, flat webbed cables, movable cables
- 4) Single-core, freely installed cables where the spacing corresponds to at least their diameter
- 5) With adjustable protective devices (motor protection switch, circuit breaker). Adjust the device to the rated cable current. Select cable circuit breaker according to DIN 57641 / VDE 0641 / CEE 19 and protective cable fuses according to DIN 57636 / VDE 0636 in accordance with the table.

5.1.1 EMC-compliant wiring

The EMC-compliant wiring of the motors is described in detail in the operating instructions of the Lenze servo inverters 9300 and ECS.

- ▶ Use of EMC threaded joints made out of metal with shield connection.
- ▶ Shield connection at the motor and at the device.

5.1.2 Wiring diagrams for servo spindle motors MDSLS



Stop!

- ▶ Securely tighten the nut of the connector.
- ▶ In case of vibration stress, secure with an O-ring:
 - Power terminal MDSLS: O-ring 18 x 1.5 mm
 - Encoder connection: O-ring 18 x 1.5 mm
 - Never pull the plug if the machine is active! The plug could be destroyed!
Inhibit the controller before pulling the plug!

Power terminal of servo spindle motors MDSLS 056 and 071

Lenze connector - standard

Pin no.	Terminal designation	Meaning
1	Y1 / BD1	Holding brake +
2	Y2 / BD2	Holding brake -
PE	PE	PE connector
4	U	Power phase U
5	V	Power phase V
6	W	Power phase W

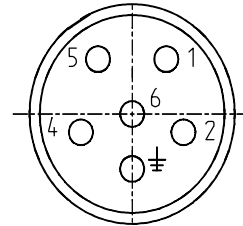

KUKA connector - compatible

Pin no.	Stranded wire colour in the box	Connection to:
4	red	Holding brake +
5	blue	Holding brake -
PE	green-yellow	PE connector
1	red	Power phase U
2	blue	Power phase V
6	black	Power phase W

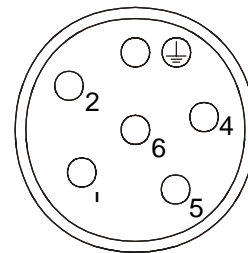

View from "outside"

Resolver connection

Lenze connector - standard (RS1)

Pin no.	Terminal designation	Meaning
1	+ Ref	Transformer windings (reference windings)
2	- Ref	
3		Not assigned
4	+ Cos	Stator windings Cosine
5	- Cos	
6	+ Sin	Stator windings Sine
7	- Sin	
8		Not assigned
9		
10		
11	+ KTY	Thermal detector +
12	- KTY	Thermal detector -

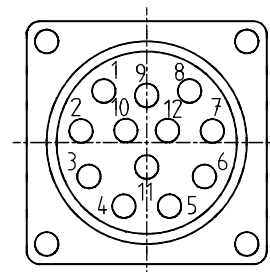

K33.0018/3

Connector KUKA - compatible (RS3)

Pin no.	Terminal designation	Connection to:
10	+ Ref	Transformer windings (reference windings)
7	- Ref	
3		Not assigned
11	+ Cos	Stator windings Cosine
12	- Cos	
1	+ Sin	Stator windings Sine
2	- Sin	
4		Not assigned
5		
6		
8	+ KTY	Thermal detector +
9	- KTY	Thermal detector -

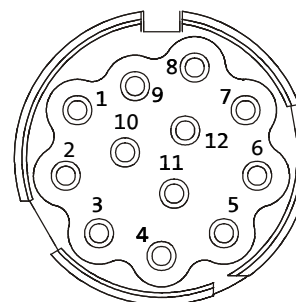

View from "outside"

Connection of incremental value encoder / SinCos absolute value encoder

Connector

Pin no.	Terminal designation	Meaning
1	B	Track B / + SIN
2	\bar{A}	Track A inverse / - COS
3	A	Track A / + COS
4	+ 5 V	Supply + 5 V / + 8 V
5	GND	Ground
6	\bar{Z}	Zero track inverse / - RS485
7	Z	Zero track / + RS485
8		Not assigned
9	\bar{B}	Track B inverse / - SIN
10		Not assigned
11	+ KTY	Thermal detector +
12	- KTY	Thermal detector -

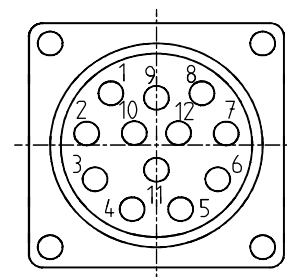

20° coded

**Stop!**

The integrated thermal sensor does not prevent overload under all conditions!
At commissioning, reduce the maximum current, e.g. to the rated current of the motor!

Perform function block interconnection (servo inverter 9300) or I²t monitoring (servo inverter ECS) with disconnection after several seconds of operation with $I > I_N$, particularly in case of danger of blocking.

- ▶ Commission the drive system according to the operating instructions of the drive controller.
 - Entering motor data, parameter setting via Global Drive Control
 - Parameter setting of motor temperature detection (is carried out automatically with parameter setting via GDC)
 - Specifying feedback system for speed and position control
 - Selecting the operating mode (control structure)
 - Entering machine data
 - Optimising the drive behaviour, if necessary (optimisation of current, speed, field and field-weakening control; observe the notes below!).

**Stop!**

The parameter data that are set via GDC are used as default setting and must be optimised specific to each application!

Servo controller 9300

The input variable of the current controller is normalised to the maximum device current $I_{\max. \text{ device}}$. This allows the maximum device current to directly influence the current controller gain V_p . If a smaller or larger device is used after the current controller adjustment, the current controller must be adjusted again or the V_p must be matched.

The input and output variables of the speed controller are normalised to the maximum current $I_{\max.}$ (C0022) and the maximum speed $n_{\max.}$ (C0011). This allows C0022 and C0011 to directly influence the gain of the speed controller V_{pn} .

- ▶ The following applies to the servo controller 9300:
 - V_p proportional $I_{\max. \text{ device}}$
 - V_{pn} proportional $n_{\max.}$ (C0011)
 - V_{pn} proportional $1/I_{\max.}$ (C0022)

Servo controller ECS

The input and output variables of the speed controller are normalised to the maximum current I_{max} (C0022) and the maximum speed n_{max} (C0011). This allows C0022 and C0011 to directly influence the gain of the speed controller V_{pn} .

- ▶ The following applies to the servo controller ECS:
 - V_{pn} proportional n_{max} . (C0011)
 - V_{pn} proportional $1/I_{max}$. (C0022)

Parameter setting of motor temperature detection



Stop!

- ▶ The integrated overload protection does not prevent overload under all conditions!
- ▶ Reduce maximum current to required value!

The motor winding temperature is monitored by thermal detectors.

Function block interconnection



Stop!

Perform function block interconnection (servo inverter 9300) or $I^2 \times t$ monitoring (servo inverter ECS) with disconnection after several seconds of operation with $I > I_N$, particularly in case of danger of blocking.

Example for the function block interconnection for MDSLS□□056-33

$$I_0 = 4.0 \text{ A, C22 } (I_{max}) = 10.5 \text{ A} \Rightarrow C472/1 = 16\%$$

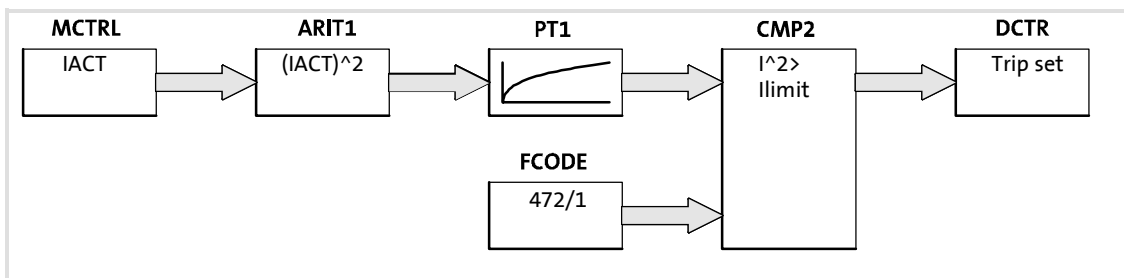

Display:

- Input value of PT1: C0642
- Output value of PT1: C0689/1
- Limit value: C0689/2

Calculation of limit value (FCODE 472/1):

$FCODE472/1 = (I_0 \cdot \frac{1}{I_{max}} \cdot 1.05)^2 \cdot 100$	I_0 [A]	Standstill current of motor
	I_{max} [A]	Maximum current set under code C22

Factor 1.05: for consideration of manufacturing tolerances and reaching the standstill torque; disconnection at $I > 1.05 \cdot I_0$

Time constant PT1: C0640 (currently 30 s)

Implementation of function block interconnection

Code list			
Code	Function block	Name	Current
C0338/000	ARIT1	Function	OUT = IN1*IN2
C0339/001	ARIT1	IN1	MCTRL-IACT
C0339/002	ARIT1	IN2	MCTRL-IACT
C0685/000	CMP2	Comparison operation	In1 > IN2
C0686/000	CMP2	Hysteresis	1%
C0687/000	CMP2	Window	1%
C0688/001	CMP2	IN1	PT1-1-OUT
C0688/002	CMP2	IN2	FCODE-472/1 (limit value)
C0871/000	DCTRL	TRIP-SET	OR1-OUT
C0830/001	OR1	IN1	CMP2-OUT
C0830/002	OR1	IN2	DIGIN4
C0830/003	OR1	IN3	Fixed 0
C0640/000	PT1-1	Time constant	30 s
C0641/000	PT1-1	IN	ARIT1-OUT
Entry in the processing list of the function blocks			
Code	Function block	Name	Current
C0685/032	---	FB processing list	ARIT1
C0465/034	---	FB processing list	PT1-1
C0465/035	---	FB processing list	CMP2
C0465/036	---	FB processing list	OR1

The configuration 1000 or 1010 (speed control) forms the basis for this function block interconnection.

6.1 Before switching on

Before the initial commissioning, before commissioning after an extended standstill time or before commissioning after an overhaul of the motor, absolutely check the following:

- ▶ Are all screwed connections of the mechanical and electrical parts firmly tightened?
- ▶ Is the unrestricted cooling-air inlet and outlet ensured?
- ▶ Are the protective devices against overheating (thermal sensor evaluation) effective?
- ▶ Is the drive controller correctly parameterised for the motor?
(📖 Drive controller operating instructions)
- ▶ Are the electrical connections o.k.?
- ▶ Does the motor connection have the correct phase sequence?
- ▶ Are rotating parts and surfaces, which can become very hot, protected against touching?
- ▶ Is the permanent lubrication connected?



Danger!

Built-in brakes are not fail-safe brakes!

6.2 Functional test

- ▶ After commissioning, check all single functions of the drive:
 - Direction of rotation of the motor
If the motor does not turn in the correct direction, exchange two phases.
 - Torque behaviour and current capacity
 - Braking effect of the mounted brake
 - Function of the feedback system
- ▶ In case of malfunctions or faults: 📖 Ch. 8.

6 Commissioning

Motor connection

Connection of SinCos encoder

6.3 Motor connection

6.3.1 Lenze standard power terminal

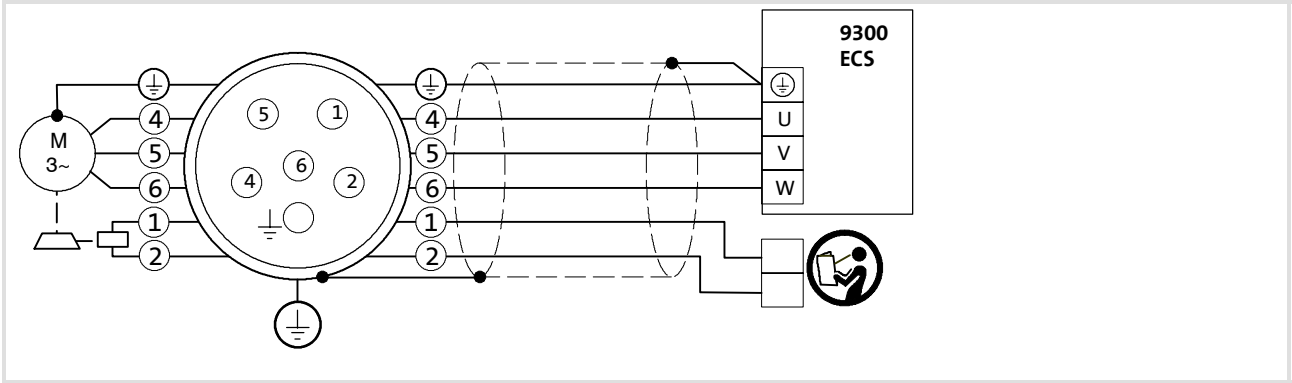

6.3.2 Lenze standard resolver connection

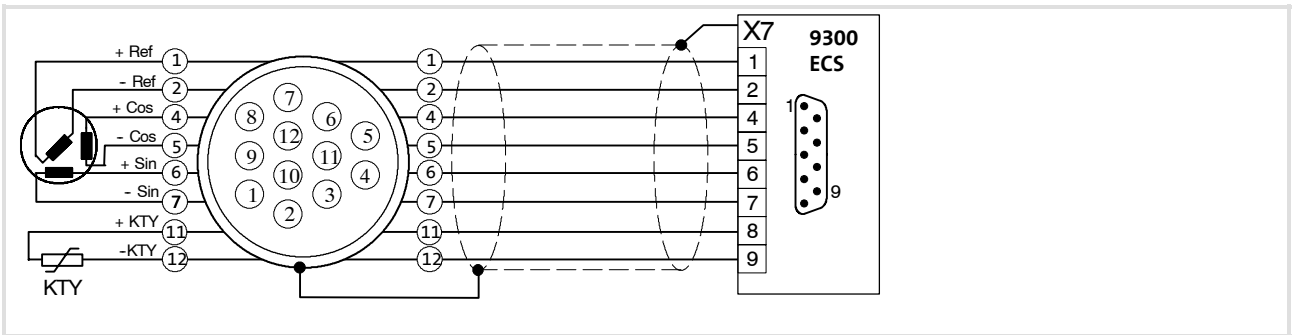

6.3.3 Connection of SinCos encoder

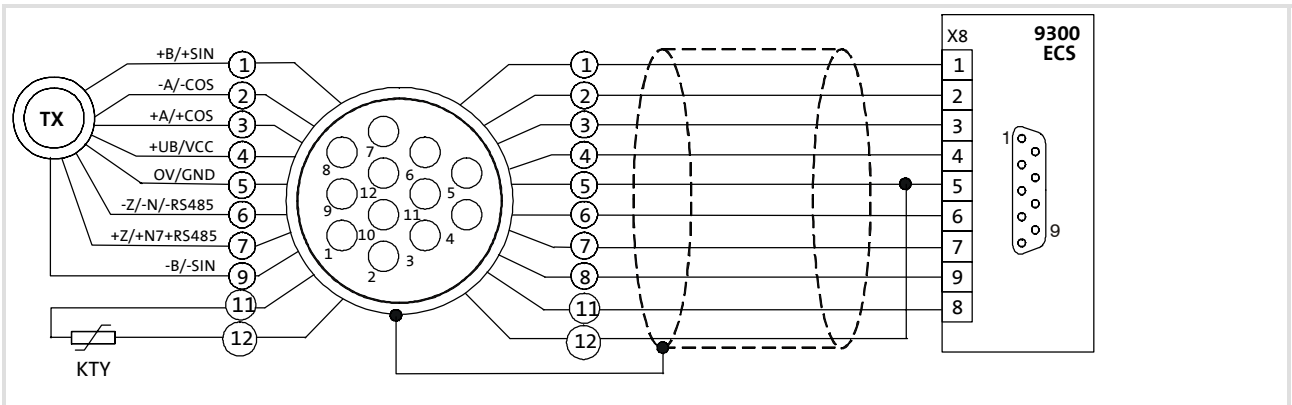

7 During operation

Perform regular inspections during operation. Check the drives approx. every 50 operating hours. Pay particular attention to:

- ▶ Unusual noises
- ▶ Excessively heated surfaces (during normal operation, temperatures can reach up to 140 °C).
- ▶ Uneven running
- ▶ Increased vibrations
- ▶ Loose fixing elements
- ▶ Condition of the electrical cables
- ▶ Obstructed heat removal
 - Deposit build-up on the drive system and in the cooling channels
- ▶ Check bellows for tightness
- ▶ Check permanent lubrication and grease supply

In case of irregularities or faults:  Ch. 8.

8 Troubleshooting and fault elimination

If faults occur during the operation of the drive system:

- ▶ First check the possible causes of malfunction according to the following table.
- ▶ Also observe the corresponding chapters in the operating instructions to the other components of the drive system.

If the fault cannot be remedied using one of the listed measures, please contact the Lenze Service.



Danger!

- ▶ Perform all work at the drive system only in the de-energised state!
- ▶ Hot motor surfaces, up to 140 °C. Observe cooling times!
- ▶ Remove the load from the motors or secure loads acting upon the drive!

Fault	Cause	Remedy
Motor becomes too warm Can only be determined through measurements; permissible surface temperatures: ● non-ventilated motors up to 140 °C ● forced- or self-ventilated motors up to 110 °C	Cooling-air volume is too low, cooling-air passages are blocked	Ensure that cooling-air inlet and outlet are unrestricted
	Cooling air is prewarmed	Ensure that fresh air is present
	Overload, with normal mains voltage the current is too high and the speed too low	Install a larger drive (determination through power measurement)
	Exceeded rated operating mode (S1 to S8 DIN 57530)	Adjust rated operating mode to the specified operating conditions. Determination of correct drive by expert or Lenze customer service
	Loose contact in supply cable (temporary single-phase operation!)	Correct loose contact
	Fuse is blown (single-phase operation!)	Replace fuse
Motor does not start	Voltage supply interrupted	<ul style="list-style-type: none"> ● Check error message at drive controller ● Check electrical connection (☞ Ch. 5)
	Controller inhibited	<ul style="list-style-type: none"> ● Check display at drive controller ● Check controller enable
	Fuse is blown	Replace fuse
	Motor protection responded	Check motor protection for correct setting and adjust it
	Motor contactor does not engage, fault in the control	Check control of motor contactor and remove fault
	Resolver cable is interrupted	<ul style="list-style-type: none"> ● Check error message at drive controller ● Check resolver cable
	Brake does not release	Check electrical connection Check air gap (see Brake operating instructions) Check continuity of magnetic coil
	Drive is blocked	Check components for easy movement, remove foreign bodies if necessary
	Motor cable polarity is reversed	Check electrical connection
Motor stops suddenly and does not restart	<ul style="list-style-type: none"> ● Motor cable polarity is reversed or ● Polarity of resolver cable is reversed 	<ul style="list-style-type: none"> ● Align the phases at the connection of the motor cable and ● Perform the correct connection of the encoder
	Overtemperature protector switch responds	<ul style="list-style-type: none"> ● Let the motor cool off <ul style="list-style-type: none"> – Reduce loading through longer acceleration times
	Overload monitoring of the inverter responds	<ul style="list-style-type: none"> ● Check settings at the drive controller ● Reduce loading from longer acceleration times
Wrong direction of rotation of the motor, correct display at controller	Reversed motor cable and resolver cable	<ul style="list-style-type: none"> ● Swapping two phases of the motor cable and ● +COS/-COS connections of the resolver connection
Uneven running	Insufficient shielding of motor or resolver cable	Check shielding and earthing (☞ Ch. 5.1.1)
	Drive controller gain too large	Adjust the gains of the controllers (see Drive controller operating instructions)
Vibrations	Insufficient alignment of the drive train	Realign the machine set, check foundation if necessary
	Loose fixing screws	Check and secure screwed connections
Running noises	Foreign bodies inside the motor	Repair by manufacturer, if necessary
	Bearing damage, spindle damage	Repair by manufacturer, if necessary
Surface temperature > 140 °C	Overload of drive	<ul style="list-style-type: none"> ● Check overload and reduce through longer acceleration times, if necessary ● Check winding temperature (☞ Ch. 9.2.2)
	Heat removal restricted due to deposit build-up	Clean surface and cooling ribs of the drives

9 Maintenance/Repair

Maintenance operations
Adjustment of resolver for synchronous servo motors

9 Maintenance/repair

9.1 Maintenance intervals

- ▶ The motors are generally maintenance-free, except for the lubrication of the spindle.
- ▶ Wear occurs only at bearings, spindles and seals.
 - Check spindle, bearings for running noises (no later than approx. 15,000 h).
- ▶ To avoid overheating, regularly remove the deposit build-up on the drives.
- ▶ It is recommended to regularly perform an inspection after approx. 50 operating hours. This allows for early identification and removal of irregularities or faults.

9.2 Maintenance operations



Stop!

- ▶ Ensure that no foreign bodies can enter the inside of the motor!
- ▶ Perform all work at the drive system only in the de-energised state!
- ▶ Separate drives from the electrical supply!
- ▶ Hot motor surfaces, up to 140 °C. Observe cooling times!
- ▶ Remove the load from the motors or secure loads acting upon the drive!
- ▶ Do not pull the plug if the machine is active!
- ▶ Check the bellows for correct seating!

9.2.1 Adjustment of resolver for synchronous servo motors

The resolver from Lenze is adjusted so that the faultless operation is ensured without adjustment at the drive controller.

If the resolver is twisted, e.g. through working on the motor, you must readjust it or perform a rotor adjustment at the drive controller.

- ▶ For the **rotor adjustment**, the motor must turn without load at the drive controller (see the operating instructions of the drive controller). The rotor adjustment is stored at the drive controller and applies only to the respective combination of motor and drive controller.

▶ Resolver adjustment

1. Release brake, if necessary, clear motor shaft end.
2. Connect resolver to controller and determine the current rotor angle (see Operating Instructions of Controller).
3. Allow DC current ($< I_N$ of motor) to flow from phase V (positive connection) to phase W (negative connection), phase U is without current.
4. Turn resolver stator so that the controller shows rotor angle "0".
5. Secure the resolver stator in this position.

9.2.2 Temperature control for servo motors

You must determine the actual winding temperature at a surface temperature > 140 °C:

- ▶ Measuring method: 4-phase resistance measurement at motor power terminal
- ▶ The resistance measurement must be performed as quickly as possible after switching off and stopping the servo motor.

Procedure

1. Unplug power connector X10, with terminal box design disconnect power supply between inverter and motor.
2. Measure the resistance between the following contacts or terminals:
 - Connector X10:
Contacts 4↔5, 5↔6 and 6↔4
 - Terminal box X11:
Terminals 1↔2, 2↔3 and 3↔1
3. The respective mean value from the three measurements corresponds to the respective double phase resistance (star connection).
 - Insert the mean values as $R_{\text{operation}}$ and R_{cold} into the following equation to calculate the winding temperature $\vartheta_{\text{operation}}$:

$\vartheta_{\text{operation}} [^{\circ}\text{C}] = \frac{R_{\text{operation}} \cdot 255}{R_{\text{cold}}} - 235$	ϑ	Winding temperature
	R	Winding resistance

9.2.3 Lubricant change

See Ch. 4.3

9.2.4 Clearing device

Fig. 2 Motor MDSLS

After disassembling the motor end guard, the spindle can be traversed by hand. In an emergency situation, the cover can be removed and the motor shaft can be turned with a 10-mm wrench.

**Stop!**

With opened end guard, the encoder system is unprotected - the enclosure is cancelled. Look out for sensitive components!

Ensure correct seating of the seals during the assembly!

9.3**Repair**

- ▶ It is recommended to have all repairs performed by Lenze Service.
- ▶ Delivery of spare parts is available upon request.