

Software Manual

9400

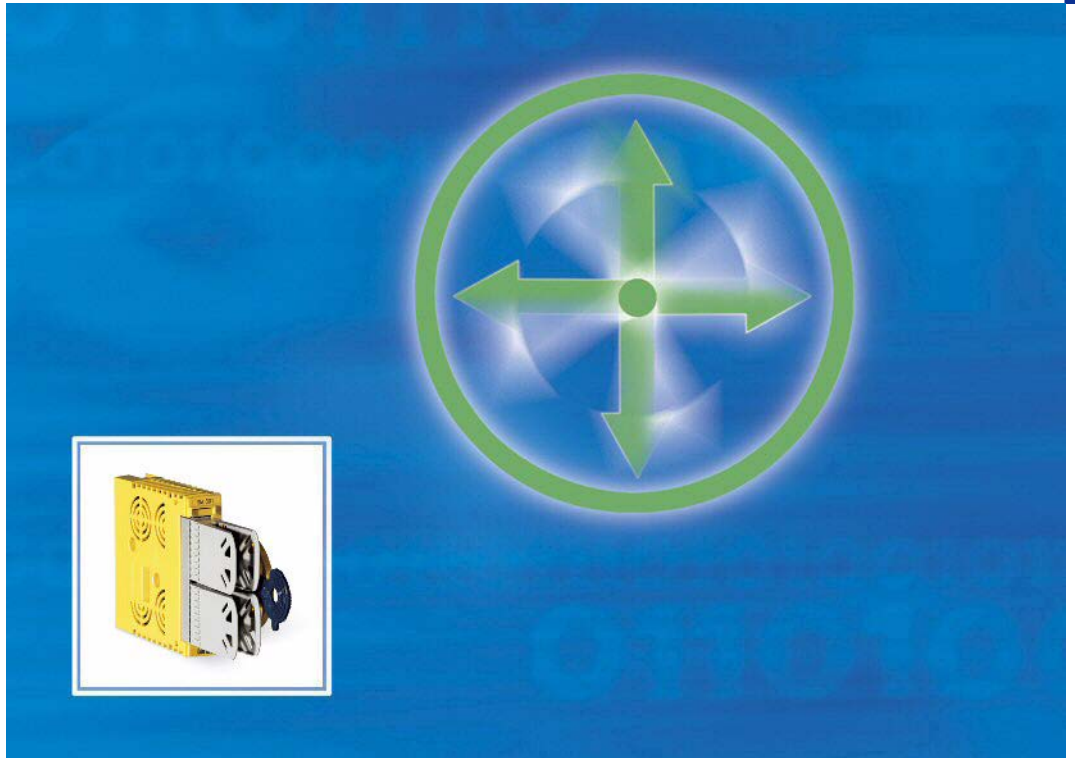

SM301 safety module (E94AYAE)
Parameter setting & configuration

Overview - technical documentation for Servo Drives 9400

Project planning, selection & ordering

- 9400 hardware manual
- Catalogue / electronic catalogue (DSC - Drive Solution Catalogue)

Mounting & wiring

- MA 9400 StateLine/HighLine
- MA for communication module
- MA for extension module
- MA for safety module
- MA for accessories
- MA for remote maintenance components

Parameter setting

- BA keypad
- SW for Lenze »Engineer« software
- SW for controller (9400 StateLine/HighLine)
- SW for regenerative power supply module
- KHB for communication module
- SW for extension module
- SW for safety module**
- SW for Lenze technology applications
- SW 9400 function library

← This documentation

Configuring

- SW for Lenze »Engineer« software
- SW for controller (9400 HighLine)
- KHB for communication module
- SW for extension module
- SW for safety module**
- SW for Lenze technology applications
- SW 9400 function library

← This documentation

Drive commissioning

- Commissioning guide
- SW for controller (9400 StateLine/HighLine)
- Remote maintenance manual

Creating a networking

- KHB for communication medium used

Legend:

- Printed documentation
- Online documentation (PDF/Engineer online help)

Abbreviations used:

- BA Operating instructions
- KHB Communication manual
- MA Mounting instructions
- SW Software manual

Contents

1	About this documentation	5
1.1	Conventions used	6
1.2	Terminology used	7
1.3	Definition of notes used	8
2	Introduction	9
2.1	Terms and abbreviations used in drive-based safety	10
2.2	Function mode of the safety module	11
2.3	Functional range of SM301 (short overview)	12
2.4	Connection to the application	14
2.5	Parameter setting & configuration	16
2.5.1	Required settings in the controller	18
2.5.2	"LS_SafetyModuleInterface" system block	19
2.5.2.1	Status information	20
2.5.2.2	I/O status information	21
2.5.2.3	Control information	22
2.5.3	"SMI_SafetyModuleInterface" system block for 9400 ServoPLC	24
2.6	Error management	25
2.6.1	Logbook function in the controller	26
2.6.2	Logbook function in the SM301	26
3	Safe configuration	28
3.1	Changing parameter settings	29
3.2	Importing/exporting parameter settings	30
3.3	Plausibility check	30
3.4	Compatibility mode	31
3.5	Protection of the safe parameters by project-related password entry	31
3.6	General parameters	32
3.6.1	Setting of the safety address	33
3.6.2	Safe speed measurement and position detection	34
3.7	Safe inputs	37
3.8	Safe output	40
3.8.1	Case study 1: "Safety door"	42
3.8.2	Case study 2: "Signalling"	43

3.9	Safety functions	44
3.9.1	Safe stop	44
3.9.1.1	Priorisation	45
3.9.1.2	Restart behaviour	46
3.9.1.3	Emergency stop function (SSE)	47
3.9.1.4	Safe torque off (STO)	47
3.9.1.5	Safe stop 1 (SS1)	48
3.9.1.6	Safe stop 2 (SS2)	49
3.9.1.7	Ramp monitoring (SS1/SS2)	51
3.9.2	Safe speed limitation	52
3.9.2.1	Safe maximum speed (SMS)	53
3.9.2.2	Safely limited speed (SLS)	54
3.9.2.3	Error analysis for the functions SMS and SLS	55
3.9.3	Operation mode selection	56
3.9.3.1	Operation mode selector (OMS)	56
3.9.3.2	Enable switch (ES)	58
3.9.4	Cascading (CAS)	59
3.9.5	Safe direction (SDI)	60
3.10	Safety bus	61
3.10.1	PROFIsafe connection	62
3.10.1.1	PROFIsafe output data	64
3.10.1.2	PROFIsafe input data	65
4	Safe parameter transfer	67
4.1	Sending safe data	68
4.2	Read safe data from device	70
4.3	Write parameter set into file	71
4.4	Read parameter set out of file	72
4.5	General reset of the device	73
4.6	Password management	74
5	Parameter reference	75
5.1	Parameter list	75
5.2	Table of attributes	104
6	Error messages	107
7	Index	129
	Your opinion is important to us	134

1 About this documentation

This documentation contains information on how to parameterise & configure the SM301 safety module.



Note!

This documentation supplements the manual for the safety module and the documentation for the controller.

The manual for the safety module contains safety instructions which must be observed!

Target group

This documentation addresses to persons who want to parameterise, configure, and diagnose an SM301 safety module attached to the Servo Drives 9400 using the L-force »Engineer« engineering software.

Validity

The information in this documentation applies to:

Safety module	Type designation	From hardware version	From software version
SM301	E94AYAE	VA	1.00

This safety module can be used together with the following standard devices:

Product range	Type designation	From hardware version	From software version
Servo Drives 9400	E94AxxExxxx	VA	1.49

- ▶ The use of the safety module in version 1.3 with parameter set version 1.3 and support of the 2-encoder concept requires standard devices of the 9400 product series from nameplate inscription:

Product range	Type designation	From hardware version	From software version
Servo Drives 9400	E94AxHExxxx	VA	07.xx
Servo Drives 9400	E94AxPExxxx	2A	02.xx

- ▶ The use of the safety module in version 1.4 with parameter set version 1.4 and support of the resolver as motor encoder requires standard devices of the 9400 product series from nameplate inscription:



Product range	Type designation	From hardware version	From software version
Servo Drives 9400	E94AxHExxxx	VA	08.xx
Servo Drives 9400	E94AxPExxxx	2A	02.xx

Document history

Version			Description
2.2	10/2011	TD05	Supplements
2.1	03/2011	TD05	Extended by new functions for SM301 V1.4
2.0	09/2009	TD05	New edition due to corporate reorganisation Extended by new functions for SM301 V1.3
1.3	10/2007	TD05	Extended by new functions for SM301 V1.2
1.2	04/2007	TD05	Extended by new functions for SM301 V1.1
1.1	10/2006	TD05	Error corrections
1.0	09/2006	TD05	First edition for SM301 V1.0

1.1 Conventions used

This documentation uses the following conventions to distinguish between different types of information.

Type of information	Writing	Examples/notes
Notation of numbers		
Decimal separators	Point	The decimal point is generally used. For example: 1234.56
Text		
Version info	Blue text colour	All pieces of information valid for only one or from a specific safety module software version is marked accordingly in this documentation. Example: The following applies from SM301 V1.1:
Program name	» «	The Lenze PC software »Engineer«...
Window	<i>italics</i>	The <i>Message window...</i> / The <i>Options...</i> dialog box
Variable identifier		Set <i>bEnable</i> to TRUE to...
Control element	bold	The OK button... / The Copy command... / The Properties tab... / The Name input field...
Sequence of menu commands		If several commands must be used in sequence to carry out a function, the individual commands are separated by an arrow. Select the File→Open command to...
Keyboard command	< bold >	Press < F1 > to open the online help. If a command requires a combination of keys, a "+" is placed between the key symbols: Use < Shift >+< ESC >...
Hyperlink	<u>underlined</u>	Highlighted reference to another topic. In this online documentation activated with a mouse-click.
Symbols		
Page reference	 6	Highlighted reference to another page. In this online documentation activated with a mouse-click.
Step-by-step instructions		Step-by-step instructions are indicated by a pictograph.

1.2 Terminology used

Term	Meaning
»Engineer«	This software from Lenze is a tool which supports you throughout the whole machine life cycle - from planning to maintenance.
Code	"Container" for one or several parameters by means of which you can parameterise or monitor the controller.
Subcode	If a code contains several parameters, these are stored in the "subcodes". In this documentation the diagonal slash "/" is used as a separator between the code and subcode (e.g. "C00118/3").
Function block	A function block (FB) can be compared with an integrated circuit which contains a certain control logic and provides one or several values when being executed. <ul style="list-style-type: none"> • An instance (reproduction, copy) of the function block is always inserted into the circuit. • It is also possible to insert several instances of a function block into a circuit. • Each instance has a unique identifier (instance name) and a processing number which defines the position where the function block is calculated during the task cycle.
System block	System blocks provide interfaces to basic functions and to the hardware of the controller in the function block editor of the »Engineer« (e.g. to the digital inputs). <ul style="list-style-type: none"> • In contrast to function blocks, system blocks cannot be instanced.

1.3 Definition of notes used

This documentation uses the following signal words and symbols to indicate dangers and important information:

Safety instructions

Structure of safety instructions:



Danger!

(characterises the type and severity of danger)

Note

(describes the danger and gives information about how to prevent dangerous situations)

Pictograph	Signal word	Meaning
	Danger!	Danger of personal injury through dangerous electrical voltage Reference to an imminent danger that may result in death or serious personal injury if the corresponding measures are not taken.
	Danger!	Danger of personal injury through a general source of danger Reference to an imminent danger that may result in death or serious personal injury if the corresponding measures are not taken.
	Stop!	Danger of property damage Reference to a possible danger that may result in property damage if the corresponding measures are not taken.

Application notes

Pictograph	Signal word	Meaning
	Note!	Important note to ensure trouble-free operation
	Tip!	Useful tip for simple handling
		Reference to another documentation

2 Introduction

Drive-based safety with L-force | 9400

The controllers of the L-force | 9400 range can be equipped with a safety module. The functional range of the safety module types varies in order to optimally implement different applications.

"Drive-based safety" stands for application-related safety functions, which can be used for the protection of persons working on machines and for machine protection.

The motion functions are still executed by the controller. The safety module monitors the safe compliance with the limit values and provides the safe inputs and outputs. When the limit values are exceeded, the safety module starts the control functions in accordance with EN 60204-1 directly in the controller.

The safety functions are suitable for applications in accordance with IEC 61508 up to SIL 3 and meet, depending on the module, the requirements of EN ISO 13849-1 up to control category 4 and Performance Level (PL) "e".

2.1 Terms and abbreviations used in drive-based safety

Abbreviation	Meaning
9400	Lenze servo controller
EC_STO	Error class stop 0
EC_SS1	Error class stop 1
EC_SS2	Error class stop 2
EC_FS	Error class fail-safe
Cat.	Category in accordance with EN 954-1
OSSD	Output Signal Switching Device, tested signal output
PS	PROFIsafe
PWM	Pulse width modulation
SD-In	Safe input ("Safe Digital Input")
SD-Out	Safe output ("Safe Digital Output")
SIL	Safety Integrity Level in accordance with IEC 61508
SM	Safety module
Optocoupler supply	Supply of optocouplers to control the power drivers
PELV	Protective Extra Low Voltage
SELV	Safety Extra Low Voltage
OFF state	Signal state of the sensors when they are activated or respond.
ON state	Signal state of the sensors in standard operation
PM	P/N switched signal paths
PP	P/P switched signal paths
GSE	File with device-specific data for establishing PROFIBUS communication
GSDML	File with device-specific data for establishing PROFINET communication.
AIS	Restart acknowledgement ("Acknowledge In Stop")
AIE	Error acknowledgement ("Acknowledge In Error")

Abbreviation	Safety function
SDI	Safe direction
SLI	Safely limited increment
SLS	Safely limited speed
SOS	Safe operating stop
SS1	Safe stop 1
SS2	Safe stop 2
SSM	Safe speed monitor
STO	Safe torque off <ul style="list-style-type: none"> Formerly: safe standstill
SMS	Safe maximum speed
SSE	Safe stop emergency
ES	Enable switch
OMS	Operation mode selector

2.2 Function mode of the safety module

Disconnecting paths

The transmission of the pulse width modulation is safely (dis-)connected by the safety module. Hence the power drivers do not create a rotating field. The motor is safely switched to torqueless operation (STO).

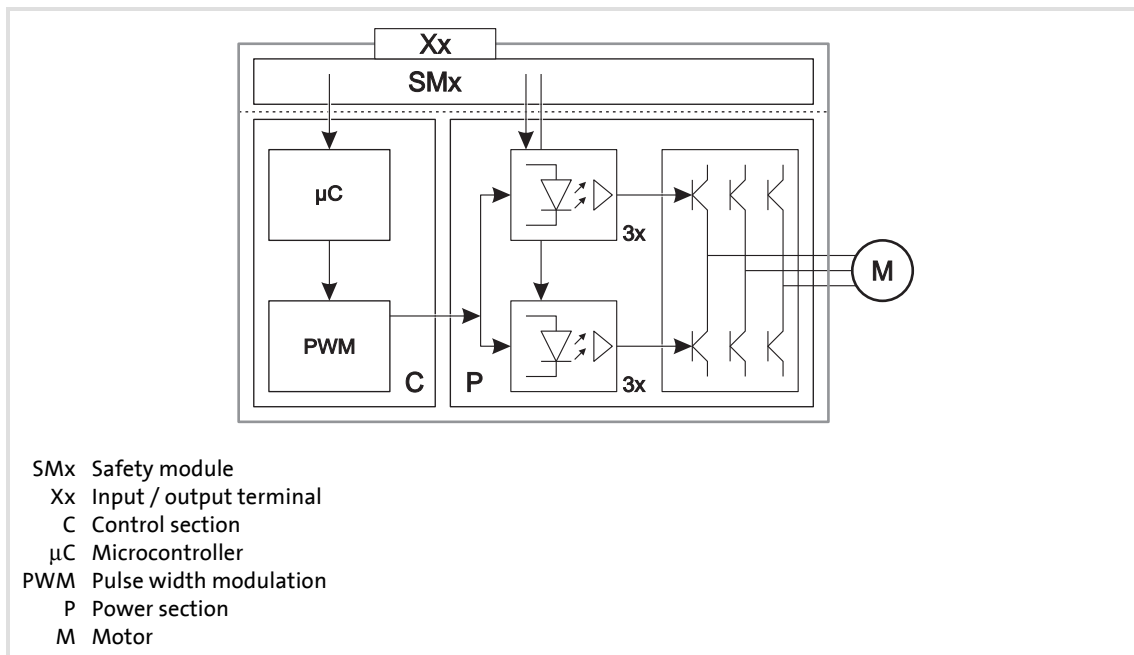

[2-1] Disconnecting paths of the safety module

Safety status

When the controller is switched off by a safety module, it is changed to the "Safe torque off active" status

- ▶ "Drive is torque-free" is entered in the logbook (0x00750003).
- ▶ In C00183, "Safe torque off active" is displayed.

Fail-safe state



Note!

If internal errors of the safety module are detected, the motor is safely switched to torqueless operation (fail-safe state).

2.3 Functional range of SM301 (short overview)

SM301 V1.0

The SM301 V1.0 safety module provides the following functions:

- ▶ Safe torque off (STO)
- ▶ Safe stop 1 (SS1)
- ▶ Safe stop 2 (SS2)
 - based on EN 61800-5-2 / SOS is speed-monitored
- ▶ Safe stop emergency
- ▶ Safe operating stop (SOS)
 - based on EN 61800-5-2 / SOS is speed-monitored
- ▶ Safe maximum speed (SMS)
- ▶ Safely limited speed 1 (SLS1)
- ▶ Enable switch (ES)
- ▶ Operation mode selector (OMS)
- ▶ Safe speed monitor (SSM)
- ▶ Safe monitor (safe output SD-Out1)
- ▶ Connection of safety sensors
- ▶ Safe parameter setting
- ▶ Safety bus connection (PROFIsafe via PROFIBUS)

SM301 V1.1

The SM301 V1.1 safety module additionally provides the following functions:

- ▶ Safely limited speed 2 (SLS2)
- ▶ Safely limited speed 3 (SLS3)
- ▶ Safely limited speed 4 (SLS4)
- ▶ Safe cascading (CAS) via SD-In4/SD-Out1
- ▶ Safety bus connection (PROFIsafe via PROFIBUS/PROFINET)

SM301 V1.2

The SM301 V1.2 safety module additionally provides the following functions:

- ▶ Parameterisable response time for encoder monitoring

SM301 V1.3

The SM301 V1.3 safety module additionally provides the following functions:

- ▶ Safe operating stop (SOS)
 - in accordance with EN 61800-5-2 / SOS is position-monitored
- ▶ Safe direction (SDI)
- ▶ Safe speed and position detection with resolver when using a motor encoder and an additional position encoder (two-encoder concept)

SM301 V1.4

The SM301 V1.4 safety module additionally provides the following functions:

- ▶ Safely limited increment (SLI)
- ▶ Safely monitored deceleration ramp for SS1/SS2
- ▶ Safe speed and position detection with resolver as motor encoder without additional position encoder

All pieces of information valid for only one or from one specific version is marked correspondingly in this documentation.

2.4 Connection to the application

When a safety function is requested, the safety system activates the corresponding safe monitoring function. The only standstill function executed directly is the "safe torque off" (STO) function. All other safety functions require a controller action which is safely monitored.



Note!

To effect the corresponding action (e.g. braking to standstill, holding the standstill position), the application engineer has to provide an appropriate interconnection in the application.

"LS_SafetyModuleInterface" system block

The **LS_SafetyModuleInterface** system block in the function block editor of the »Engineer« serves to transmit the control and status information from the safety module to the application.

- ▶ For controllers of the "9400 ServoPLC" series, the **SMI_SafetyModuleInterface** system block in the control configuration of the »PLC Designer« provides the interface for the safety module. The contents of this interface conform to the description for the **LS_SafetyModuleInterface** system block

"LS_Limiter" system block/basic function "Limiter"

Moreover, the **LS_Limiter** system block, which contains the basic function "Limiter", is available in the function block editor to integrate the safety system in the application.

- ▶ The basic function "Limiter" provides a parameter setting interface in the »Engineer« for comfortably setting limit positions, limited speeds, and limit values and enables the drive to be braked accurately **after being requested** by the safety module.
- ▶ If the basic function "Limiter" is to act directly on a request by the safety module, the *LIM_dwControl* input of the **LS_Limiter** system block must be connected to the *SMI_dwControl* output of the **LS_SafetyModuleInterface** system block.

Basic procedure

1. Activation of the safety function in the safety module (e.g. SS1 - safe stop 1).
→ Monitoring starts.
2. Via a control word, the safety module transmits the information to the controller that the safety function has been activated.
3. The application evaluates the control word and starts the required motion sequence (e.g. braking).



Note!

If communication to the controller is interrupted, e.g. by switching off the controller, the safety module responds with the following actions:

- Error stop with STO is activated.
- Error message "Warning" is transmitted.
- The LED "ME" is blinking.

The required error acknowledgement (AIE) is possible via terminal or safety bus.

Further information can be found in the chapter "[Error management](#)". (25)

2.5 Parameter setting & configuration



Note!

Safety-relevant parameters can only be transmitted to the safety module via safe parameter setting with the »Engineer«.

The parameter set is stored in the memory module and in the safety module with a unique module ID which must comply to the effective safety address in the safety module.

If you select the SM301 safety module in the *Project view* of the »Engineer«, the following tabs are available in the *Operating range*:

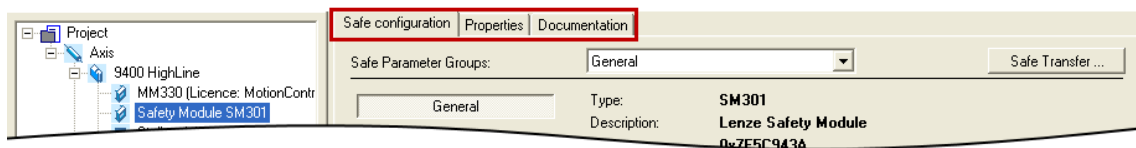

Tab	Info
Safe configuration	Via the <i>Safe configuration</i> tab, the SM301 safety module can be safely configured. ▶ Safe configuration (📖 28)
Properties	The <i>Properties</i> tab displays general information for the safety module, e.g. product name, order number, and version.
Documentation	The <i>Documentation</i> tab serves to add notes and electronic documents to the safety module. <ul style="list-style-type: none"> • Detailed information on adding documentations can be found in the »Engineer« documentation in the chapter "Project structure".

Safe parameter transfer

By clicking **Safe transfer** on the *Safe configuration* tab, the *Safe transfer* dialog box opens which provides the functions for the safe parameter transfer. ▶ [Safe parameter transfer](#) (📖 67)

Service status

If you request the "Send safe data to device" function in the *Safe transfer* dialog box via the **Send** button, the safety module changes to the "Service status" which is required for a safe parameter setting. ▶ [Sending safe data](#) (📖 68)

The service status means:

- ▶ Normal stop is active and the drive is safely switched to torqueless operation (STO).
 - ▶ [Safe stop](#) (📖 44)
- ▶ The safe inputs are evaluated as OFF state.
- ▶ The safe output was set to OFF state.
- ▶ Communication via safety bus is - if possible - active, but passivated.



Note!

- The service status is also active if the parameter set in the memory module does not comply to the parameter set in the safety module during the initialisation.
- The service status can be exited by reinitialising the safety module, i.e. communication via the safety bus is interrupted.

Supported interfaces for a safe parameter setting

A safe parameter setting with the »Engineer« from version 1.4 is supported via the following interfaces:

- ▶ Diagnostic interface X6 (with E94AZCUS diagnostic USB adapter)
- ▶ Ethernet (E94AYCEN communication module)
- ▶ System bus (CAN on board / E94AYCCA communication module)

2.5.1 Required settings in the controller



Note!

When communicating online via a bus system it may happen that several users access one and the same drive at the same time and edit the safe parameter set.

After transferring the safe parameters, it must be checked whether the check sums (CRC) of the parameter set, memory module, and the safety module comply to each other in the *Safe Transfer* dialog box.

Since safe parameter access through several users cannot be technically avoided at present, organisational measures are required to ensure the consistency of the safe parameters.

Use [C00214](#) to set the safety module which is expected by the application or controller.

- ▶ In the »Engineer« this setting is made automatically by assigning the device modules to the controller, i.e. the »Engineer« automatically sets [C00214](#) according to the safety module selected.
- ▶ If the safety module set in [C00214](#) does not comply to the plugged-in safety module type, an error (fault) is triggered. The error can only be eliminated by mains switching.

Parameter Name: C00214 Required safety module		Data type: UNSIGNED_8 Index: 24361 _d = 5F29 _h
Setting of the expected safety module		
Selection list		
1	SM0	
2	SM100	
4	SM300	
5	SM301	
<input checked="" type="checkbox"/> Read access <input checked="" type="checkbox"/> Write access <input type="checkbox"/> CINH <input type="checkbox"/> PLC STOP <input type="checkbox"/> No transfer <input type="checkbox"/> COM <input type="checkbox"/> MOT		

2.5.2 "LS_SafetyModuleInterface" system block

The **LS_SafetyModuleInterface** system block is the interface to the safety module in the function block editor of the »Engineer«.

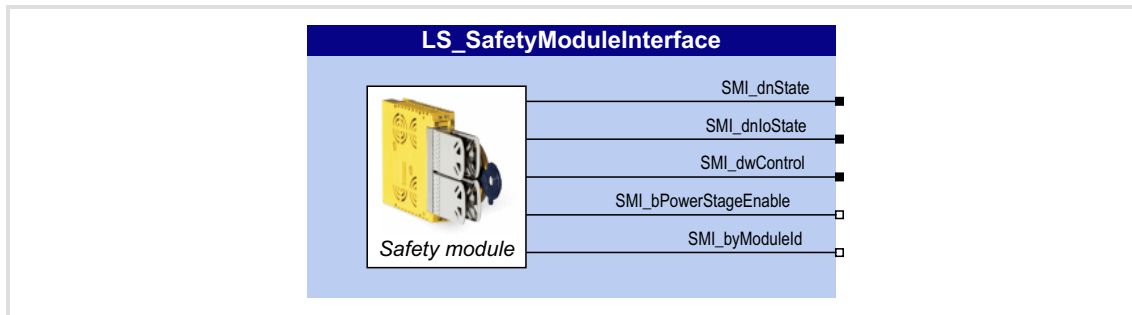

Outputs

Output	Data type	Value/meaning
SMI_dnState	DINT	Bit-coded status information from the safety module ▶ Status information (20)
SMI_dnIoState	DINT	Bit-coded I/O status information from the safety module ▶ I/O status information (21)
SMI_dwControl	DWORD	Bit-coded control information from the safety module ▶ Control information (22)
SMI_bPowerStageEnable	BOOL	Status signal "Inverter enable" TRUE Inverter is enabled by the safety module.
SMI_byModuleId	Byte	ID of the safety module in the controller

SM301 safety module | Parameter setting & configuration

Introduction

Parameter setting & configuration | "LS_SafetyModuleInterface" system block

2.5.2.1 Status information

Via the bit-coded status signal *SMI_dnState* of the SB LS_SafetyModuleInterface the SM301 safety module transmits the status of safety functions to the application.

Bit	Name	Meaning
0	STO	Safe torque off (STO) function is active. • The drive is safely switched to torqueless operation.
3	EC_STO	Error stop category 0: Function Safe torque off (STO) is active.
4	EC_SS1	Error stop category 1: Function Safe stop 1 (SS1) is active.
5	EC_SS2	Error stop category 2: Function Safe stop 2 (SS2) is active.
8	SLS1 monitored	Safely limited speed 1 is activated and observed.
9	SLS2 monitored *	Safely limited speed 2 is activated and observed.
10	SLS3 monitored *	Safely limited speed 3 is activated and observed.
11	SLS4 monitored *	Safely limited speed 4 is activated and observed.
12	SDIpos monitored **	Safe positive direction (SDIpos) is activated and observed.
13	SDIneg monitored **	Safe negative direction (SDIneg) is activated and observed.
14	Error active	SM301 safety module in error status (trouble or warning).

* From SM301 V1.1 ** From SM301 V1.3
Unlisted bits are reserved for future extensions!

[2-1] Bit coding of the status signal *SMI_dnState*



Tip!

For decoding the status signal into individual boolean status signals, simply connect the *SMI_dnState* output to the *L_DevSMStateDecoder* FB which is available in the function library from V2.0.

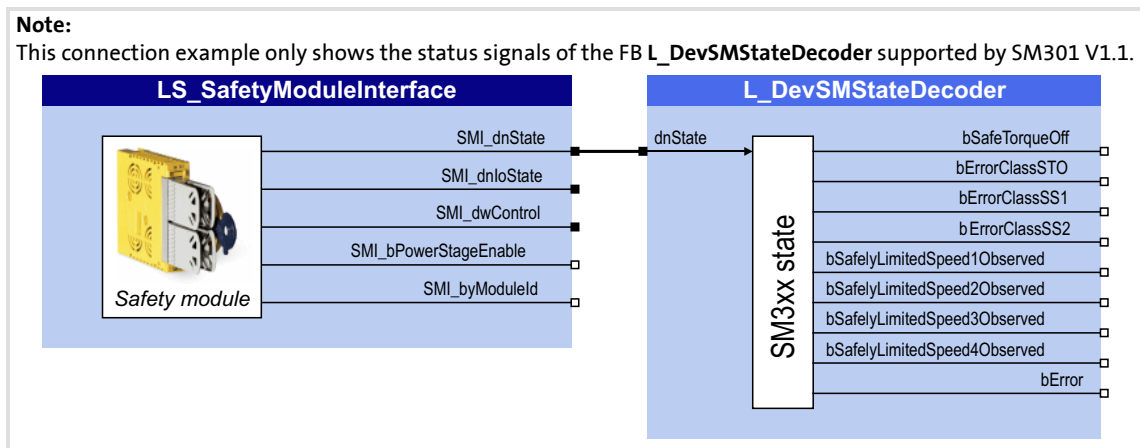

[2-2] Example: Decoding of the *SMI_dnState* status signal into individual boolean status signals

2.5.2.2 I/O status information

Via the bit-coded status signal *SMI_dnIoState* of the SB **LS_SafetyModuleInterface** the SM301 safety module transmits the status of the safe inputs and the safe output to the application:

Bit	Name	Meaning
0	SD-In1	Sensor input 1 in the ON state.
1	SD-In2	Sensor input 2 in the ON state.
2	SD-In3	Sensor input 3 in the ON state.
3	SD-In4	Sensor input 4 in the ON state.
5	AIS	Restart is acknowledged via terminal (negative edge: 1↘0).
6	AIE	Error is acknowledged via terminal (negative edge: 1↘0).
8	PS_AIS	Restart is acknowledged via safety bus (positive edge: 0↗1).
9	PS_AIE	Error is acknowledged via safety bus (positive edge: 0↗1).
12	SD-Out1	Safe output 1 (feedback output) in the ON state.

Unlisted bits are reserved for future extensions!

[2-2] Bit coding of the status signal *SMI_dnIoState*



Tip!

For decoding the status signal into individual boolean status signals, simply connect the *SMI_dnIoState* output to the **L_DevSMStateDecoderIO** FB which is available in the function library from V2.0.

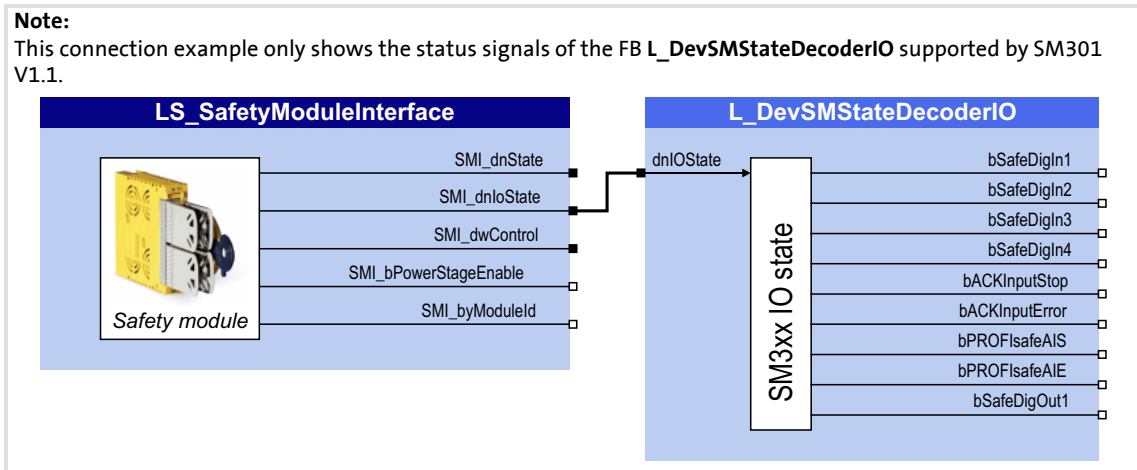

[2-3] Example: Decoding of the *SMI_dnIoState* status signal into individual boolean status signals

SM301 safety module | Parameter setting & configuration

Introduction

Parameter setting & configuration | "LS_SafetyModuleInterface" system block

2.5.2.3 Control information

Via the bit-coded control signal *SMI_dwControl* of the SB **LS_SafetyModuleInterface** the SM301 safety module transmits information about requested/active safety functions to the application.

► It is also possible to request/activate several safety functions at the same time.

Bit	Name	Meaning
1	SS1 active	Safe stop 1 (SS1) function is active. <ul style="list-style-type: none">After the parameterised stopping time has elapsed, bit 0 of the status signal <i>SMI_dnState</i> (STO active) is set.
2	SS2 active	Safe stop 2 (SS2) function is active. <ul style="list-style-type: none">After the parameterised stopping time has elapsed, bit 16 (SOS monitored) is set.
3	SLS1 active	Safely limited speed 1 (SLS1) function is active. <ul style="list-style-type: none">After the parameterised braking time Nlim1 has elapsed, bit 8 of the status signal <i>SMI_dnState</i> (SLS1 monitored) is set additionally.
4	SLS2 active *	Safely limited speed 2 (SLS2) function is active. <ul style="list-style-type: none">After the parameterised braking time Nlim2 has elapsed, bit 9 of the status signal <i>SMI_dnState</i> (SLS2 monitored) is set additionally.
5	SLS3 active *	Safely limited speed 3 (SLS3) function is active. <ul style="list-style-type: none">After the parameterised braking time Nlim3 has elapsed, bit 10 of the status signal <i>SMI_dnState</i> (SLS3 monitored) is set additionally.
6	SLS4 active *	Safely limited speed 4 (SLS4) function is active. <ul style="list-style-type: none">After the parameterised braking time Nlim4 has elapsed, bit 11 of the status signal <i>SMI_dnState</i> (SLS4 monitored) is set additionally.
7	SDIpos active **	Function Safe positive direction (SDIpos) is active. <ul style="list-style-type: none">After the parameterised SDI delay time has elapsed, bit 12 of the status signal <i>SMI_dnState</i> (SDIpos monitored) is set additionally.
8	SDIneg active **	Function Safe negative direction (SDIneg) is active. <ul style="list-style-type: none">After the parameterised SDI delay time has elapsed, bit 13 of the status signal <i>SMI_dnState</i> (SDIneg monitored) is set additionally.
9	ES active	Enable switch (ES) function for motion functions in special operation is active.
10	SLI is active ***	"Safely limited increment (SLI)" function is active.
11	OMS	Operation mode selector (OMS) function for special operation is requested.
16	SOS active	"Safe operating stop" (SOS) function is active. <ul style="list-style-type: none">The safe operating stop is monitored.The function will be active after the function Safe stop 2 (SS2) has ended.
23	SSE active	Emergency stop function (SSE) is active. <ul style="list-style-type: none">Depending on the parameterisation of the emergency stop function, bit 1 (SS1 active) or bit 0 of the status signal <i>SMI_dnState</i> (STO active) is set after the function has ended.
29	OMS active *	Special operation is active.

* From SM301 V1.1 ** From SM301 V1.3 *** From SM301 V1.4
Unlisted bits are reserved for future extensions!

[2-3] Bit coding of the control signal *SMI_dwControl*



Note!

To effect the corresponding action (e.g. braking to standstill, holding the standstill position), the application engineer has to provide an appropriate interconnection in the application.

- For connecting the basic function "Limiter", the *SMI_dwControl* output must be connected to the *LIM_dwControl* input of the *LS_Limiter* system block.



Tip!

For decoding/coding the control signal, the function blocks *L_DevSMControlDecoder* and *L_DevSMControlEncoder* are available in the function library from V2.0.

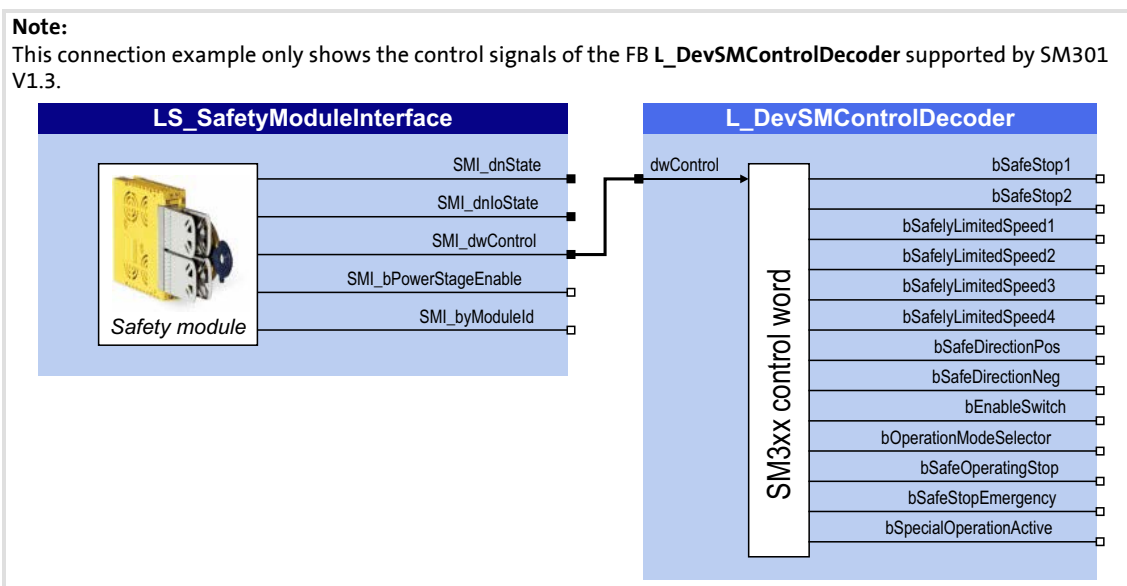

[2-4] Example: Decoding of the *SMI_dwControl* control signal into individual boolean control signals

2.5.3 "SMI_SafetyModuleInterface" system block for 9400 ServoPLC

For controllers of the "9400 ServoPLC" series the **SMI_SafetyModuleInterface** system block in the control configuration of the »PLC Designer« provides the interface for the safety module.

System variable	Data type	Value/meaning
SMI_dnState	DINT	Bit-coded status information from the safety module ▶ Status information (📖 20)
SMI_dnIoState	DINT	Bit-coded I/O status information from the safety module ▶ I/O status information (📖 21)
SMI_dwControl	DWORD	Bit-coded control information from the safety module ▶ Control information (📖 22)
SMI_bPowerStageEnable	BOOL	Status signal "Inverter enable" TRUE Inverter is enabled by the safety module.
SMI_byModuleId	Byte	ID of the safety module in the controller



The descriptions in the previous chapter "[LS_SafetyModuleInterface](#)" system block apply to this system block in the same way.

2.6 Error management



Error messages of the safety module

For a description of all error messages of the safety module and their causes & possible remedies, please see the chapter "[Error messages](#)". (□ 107)

Error states

Detected errors or maloperation of the drive are assigned to error states with definite responses. The response can be co-ordinated with the whole drive via the error states.

Features	Error status		
	System error	Fault	Warning
Event	Fatal internal error	Error	Monitoring function
LED "ME"	On	Blinking	Flashing
Status of safety module	Lockout (CPU stopped)	Error status	Standard operation
The control category in accordance with EN 13849-1...	... has been exited		... has not been exited
Response	The motor is safely switched to torqueless operation via STO immediately	The motor is safely switched to torqueless operation via STO or shut down via SS1 immediately (parameterisable)	
Acknowledgement after event has been eliminated	Switching 24 V supply at the safety module off and then on again	<ul style="list-style-type: none"> • Error acknowledgement (AIE) via terminal X82.2 (positive signal pulse with a signal duration of 0.3 ... 10 s) • Error acknowledgement (AIE) via safety bus (bit "PS_AIE") • Switching the 24 V supply at the safety module off and then on again 	



Note!

If the system error still occurs after switching the 24 V supply, please contact the Lenze service!

Error in PROFIsafe communication

If errors in the PROFIsafe communication occur, the PROFIsafe driver passivates the data. After PROFIsafe communication has been reinitialised, the drive is automatically enabled again unless a standstill function is selected.

Events which cause an error status are sent as a diagnostic telegram via PROFIBUS. From V1.1 onwards, PROFINET is also supported.

2.6.1 Logbook function in the controller

The logbook function integrated in the controller records important events in the system in chronological order, including error states of the safety module.



Tip!

When an online connection has been established, the logbook can be displayed in the »Engineer« via the **Logbook** button on the **Diagnostics** tab for the controller.

Detailed information on the logbook can be found in the online help for the controller.

2.6.2 Logbook function in the SM301

From SM301 V1.4

For purposes of diagnostics, a simple logbook with ten entries is implemented in the SM301. Changes with regard to the request of safety functions in the SM301 are logged. The bit coded log status created in a 2-ms cycle serves as a basis for the logbook. A logbook entry is generated when the log status has changed.

- ▶ The logbook function can be controlled via the "Log function" parameter ([C15891](#)).
 - The parameter can be written without using the parameter setting interface.
 - Possible settings:

Selection list	Info
0 Logging active	The logbook function is permanently active (Lenze setting). <ul style="list-style-type: none">• When this value is written, all logbook entries are deleted.
1 Logging stopped	The logging of further entries is stopped.
2 Stop logging in the event of an error	Logbook entries are logged until an error occurs (bit 31 in C15000 set). <ul style="list-style-type: none">• When this value is written, all logbook entries are deleted.
3 Stop logging in the case of STO	Logbook entries are logged until Safe torque off (STO) is triggered (bit 0 in C15000 set). <ul style="list-style-type: none">• When this value is written, all logbook entries are deleted.
4 Stop logging in the case of SS1	Logbook entries are logged until Safe stop 1 (SS1) is triggered (bit 1 in C15000 set). <ul style="list-style-type: none">• When this value is written, all logbook entries are deleted.
5 Stop logging in the case of SS2	Logbook entries are logged until Safe stop 2 (SS2) is triggered (bit 2 in C15000 set). <ul style="list-style-type: none">• When this value is written, all logbook entries are deleted.

- ▶ A logbook entry consists of the two corresponding subcodes of parameters "Log time" ([C15892](#)) and "Log status" ([C15893](#)).

Short overview of the relevant parameters:

Parameter	Info	Lenze setting
C15890	Current time	- ms
C15891	Log function	Logging active
C15892/1...10	Log time <ul style="list-style-type: none"> Time of the entry in milliseconds since switch-on of the module supply. 	- ms
C15893/1...10	Log status <ul style="list-style-type: none"> Status (bit coded) at the time displayed in C15892/1...10. 	-

Grayed out = display parameter



Note!

Before the display parameters of the logbook are read out for purposes of diagnostics, the logbook function should be stopped by selecting "1: Logging stopped" in [C15891](#), in order to avoid inconsistencies.

3 Safe configuration

The SM301 safety module can be safely configured in the »Engineer« on the *Safe configuration* tab for the SM301 safety module

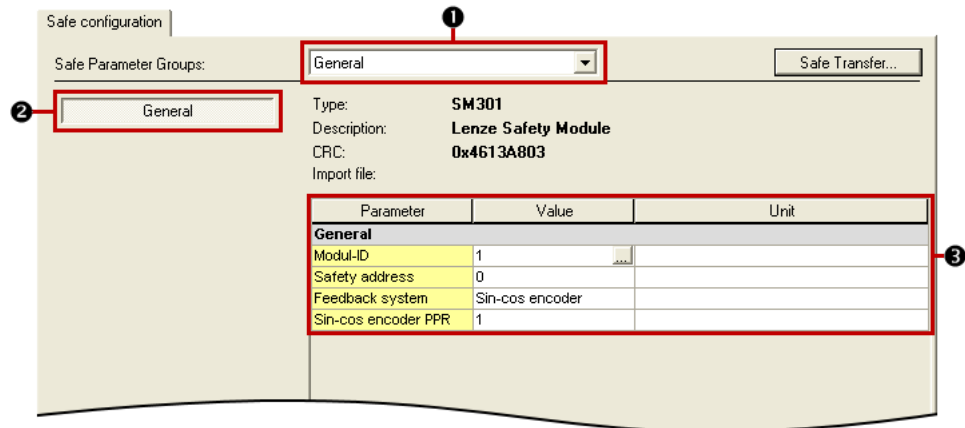

The parameters of the safety module are divided into different groups according to their functions.

- ▶ A group is selected via the **Parameter groups** ❶ list field.
- ▶ For a better overview, some parameter groups are divided again into functional subgroups which can be selected via the buttons ❷ on the left.
- ▶ In the parameter list ❸ all parameters of the parameter group/subgroup selected are displayed.
 - The **Value** field serves to change the corresponding parameter value.
 - ▶ [Changing parameter settings](#) (📖 29)
 - The context menu (right mouse button) provides functions for the import/export of the parameter settings.
 - ▶ [Importing/exporting parameter settings](#) (📖 30)

💡 Tip!

If you place the mouse pointer on a parameter, further information on the parameter will be displayed in a pop-up window.

If you select the entry "All parameters" in the **Parameter groups** list field, all parameters of the safety module are displayed on the tab.

The **File→Print** command in the »Engineer« *menu bar* serves to print all parameter settings of the safety module for the purpose of documentation.

3.1 Changing parameter settings



Note!

Changed parameters of the safety module are not automatically transmitted to the device, even if an online connection has been established!

The parameter set for the safety module is only safely transmitted when clicking the **Send** button in the *Safe transfer* dialog box!

▶ [Sending safe data](#) (68)



How to change a parameter setting:

1. Select the parameter to be changed from the list.
2. Enter the new value in the **Value** column or select it from the defined options.
 - Invalid or impermissible values are displayed in "red" in the input field.
 - A selection from the list field may cause a deactivation of parameters which are now irrelevant due to the selection (marked by a grey background colour).
3. Press the **<Return key>** or click into another box to accept the changed value.
 - By pressing the **<Esc>** key you can cancel the entry.



Tip!

The parameter settings of the safety module can also be displayed in the »Engineer« parameter list (*All parameters tab* → **Safety module SM301**) category and on the keypad. Changes, however, are only possible via the *Safe configuration* tab!

3.2 Importing/exporting parameter settings

For transmitting/copying the parameter settings of the safety module to other safety modules, the import/export functions can be used which are available in the parameter list via the *Context menu* (right mouse button).

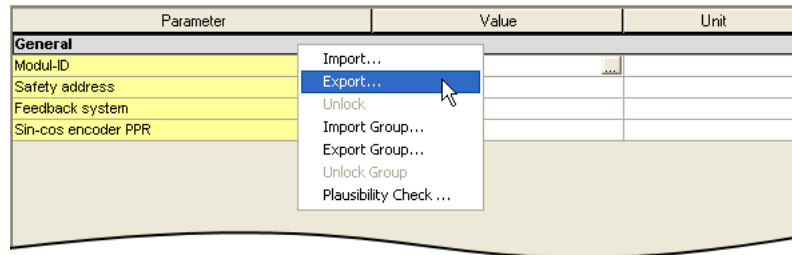

Command in the context menu	Info
Import...	Import all parameter settings from the file. <ul style="list-style-type: none"> Only compatible files are offered for the import.
Export...	Export all parameter settings to the file.
Unlock	Unlock imported parameter settings. <ul style="list-style-type: none"> After the "Import" function has been executed, the imported parameter settings are protected against change by the user. Only an explicit unlocking enables a change again.
Import group...	Import parameter settings of a group from a file. <ul style="list-style-type: none"> Only possible when selecting a parameter group. Only compatible files are offered for the import.
Export group...	Export parameter settings of a group to a file. <ul style="list-style-type: none"> Only possible when selecting a parameter group.
Unlock group	Unlock imported parameter settings of a group. <ul style="list-style-type: none"> After the "Import group" function has been executed, the imported parameter settings are protected against change by the user. Only an explicit unlocking enables a change again.

3.3 Plausibility check

Before transmitting the parameter set to the safety module, a plausibility check always takes place.



Note!

Only a plausible parameter set can be transmitted to the safety module using the "Send safe data" function!

With the **Plausibility check...** command in the *Context menu* (right mouse button) of the parameter list you can start the plausibility check manually to check the changes made in the parameter settings with regard to plausibility.

- ▶ After the plausibility check a status message indicates whether the plausibility check was successful.
- ▶ If the plausibility check failed, the status message contains the parameters with implausible settings.

3.4 Compatibility mode

The functional range of the SM301 safety module which can be parameterised in the »Engineer« via the *Safe configuration* tab depends on the version of the safety module selected for the controller via the *Insert device module* dialog box.

Existing projects created e.g. with an SM301 V1.0 safety module can also be downloaded into a controller with a plugged-in SM301 V1.1 safety module. In this example, the functional range which can be parameterised via the *Safe configuration* tab corresponds to the one of the SM301 V1.0 safety module (V1.0 compatibility mode).



Tip!

[C15016](#) displays the parameter set version of the safety module.

3.5 Protection of the safe parameters by project-related password entry

This function is available from »Engineer« HighLevel V2.14!

The »Engineer« provides a password protection which serves to protect the parameter setting of the higher-order safety functions from alterations in the project for the device series 8400 and 9400.

The password...

- ▶ ...can be set on the *Protection* tab when the project root element has been selected in the project tree.
- ▶ ...is only valid inside the project (no transmission to the controller or safety module). If a password is stored in the project and this project is used, the safe parameters can only be edited after the password has been entered.



How to activate the protection of the save parameters:

1. Select the project root element in the  project tree.
2. Assign the desired password on the *Protection* tab.
 - After the password has been set, the safe parameters (tab *Safe configuration*, safe parameters) of all included devices can only be edited inside the project after the corresponding password has been entered.

3.6 General parameters

Short overview of "General" parameter group:

Parameter	Info	Lenze setting
-	Module ID	1
C15111	Safety address	0
C15400	Encoder system (<i>designation up to V1.2</i>)	Sin-cos encoder
	Motor encoder system (<i>designation from V1.3</i>)	
C15409	Motor mounting direction **	Motor rotating in CW direction
C15420	Sin-cos encoder - number of increments	1
C15430	Number of pole pairs of resolver *	1
C15500	Position encoder system *	No position encoder
C15501	Position encoder gearbox factor *	100 %
C15502	Position encoder mounting direction *	Like motor encoder

* From SM301 V1.3 ** From SM301 V1.4

Module ID

Unique identification (1 ... 65534) for the safe device.

Safety address

The safety address serves as a unique identification of the SM301 safety module in systems with several drives.

▶ [Setting of the safety address](#) (📖 33)

Motor encoder system

Selection of the motor encoder system for a safe speed measurement.

▶ [Safe speed measurement and position detection](#) (📖 34)

Motor mounting direction

Via the setting of the motor mounting direction, information regarding the sign is taken into consideration during the calculation of the safe position and speed measurement.

Sin-cos encoder - number of increments

Number of increments of the sin/cos encoder used for safe speed measurement if "Sin/cos encoder" is selected as encoder system.

▶ [Safe speed measurement and position detection](#) (📖 34)

3.6.1 Setting of the safety address

The safety address can be set via the DIP switch of the safety module or via the "safety address" parameter ([C15111](#)).



Note!

- The DIP switch in the left housing side of the safety module can only be set if the safety module is not plugged into the controller.
- The setting of the safety address via parameter setting is only possible if the safety address "0" is set with the DIP switch. Otherwise the safety address set via the DIP switch is used.
- The safety address "0" is not permissible!

Setting via DIP switch

- ▶ The DIP switch serves to set addresses in the range of 0 ... 1023:

DIP switch	Labelling										
	1	2	3	4	5	6	7	8	9	0	
Value of the address bit	1	2	4	8	16	32	64	128	256	512	

- ▶ Changes of the safety address via the DIP switch are only activated when the 24 V supply is switched on.
- ▶ [C15101](#) displays the safety address set with the DIP switch.

Setting via parameter setting

- ▶ Via the parameter "safety address" ([C15111](#)) addresses in the range of 0 ... 65534 can be set.

Effective safety address

The effective safety address is the result of the setting via DIP switch or parameter setting.

- ▶ The effective safety address must match the module ID assigned in the safe parameter set.
- ▶ If "PROFIsafe" has been selected as safety bus, the effective safety address is accepted simultaneously as the PROFIsafe target address. This address must match the corresponding configuration of the safety PLC.



Tip!

[C15112](#) displays the effective safety address.

3.6.2 Safe speed measurement and position detection

For safe speed measurement a sin/cos encoder must be connected to terminal X8 (Sub-D) at the controller.

From [SM301 V1.3](#), you can alternatively connect a two-encoder system consisting of a motor and a position encoder. When a two-encoder system is selected, a resolver can be used as motor encoder.

From [SM301 V1.4](#) you can carry out the safe speed and position detection via a resolver without the use of an additional position encoder. For this, connect the resolver to terminal X7.

Safe speed measurement - properties		Explanations
Max. speed	±16000 rpm	Restriction for the use of a resolver: ±(10000 rpm/number of resolver pole pairs)
Response time encoder monitoring	≥ 12 ms *	Time required to detect faults caused by continuous signal errors at the encoder interface. * From SM301 V1.2 : The response time can be parameterised via C15410 . * From SM301 V1.4 : If the resolver is used as a motor encoder without an additional position encoder, the response time ≥ 50 ms has to be set.
Error response	Error stop (STO)	
Tolerance threshold of speed comparison	20 rpm **	The speed measured by the standard device and the speed measured by the safety module are checked for plausibility. <ul style="list-style-type: none"> Up to SM301 V1.2, the maximum deviation (after approx. 2 seconds of filtering) is fixedly set to the limit value of 20 rpm. The filter time of approx. 2 s is part of the diagnostics function and irrespective of the response time. * From SM301 V1.3 : The tolerance threshold can be parameterised under C15411 . Important: Select the tolerance threshold as low as possible. If a speed/position information does not come in during operation, the diagnostics function must be able to detect this. So, the parameterised tolerance threshold must be exceeded during operation for at least more than 2 seconds to ensure the two-channel encoder information transfer. Selecting the tolerance threshold too low may lead to a restricted plant availability.



Note!

It is necessary to assess the minimum response time required for the respective system.

A longer response time results in a higher system availability if, for instance, short-time, process-related speed steps occur at safe operational stop during setting-up operation.

The following speed-dependent functions require information from the safe speed measurement:

- ▶ [Ramp monitoring \(SS1/SS2\)](#) (☰ 51)
- ▶ [Safe stop 2 \(SS2\)](#) (☰ 49)
- ▶ Safe operating stop (SOS)
 - up to SM301 V1.2 in accordance with EN 61800-5-2 / SOS is speed-monitored
- ▶ [Safe maximum speed \(SMS\)](#) (☰ 53)
- ▶ [Safely limited speed \(SLS\)](#) (☰ 54)
- ▶ Safe speed monitor (SSM)

The following position-dependent functions require information from the safe position detection:

- ▶ Safe operating stop (SOS)
 - in accordance with EN 61800-5-2 standard / SOS is position-monitored (from SM301 V1.3)
- ▶ [Safe direction \(SDI\)](#) (☰ 60)
- ▶ Safely limited increment (SLI)



Note!

The speed-dependent functions must not be parameterised if "No encoder system" is set. The plausibility check rejects such implausible settings until they have been parameterised correctly.



Stop!

Malfunctions due to slip, shaft fractures, etc.

Due to slip, shaft fractures, etc. between the motor and the encoder system, the safe speed measurement is faulty.

Possible consequences:

- The speed-dependent functions are executed incorrectly.

Protective measures:

- Prevent malfunctions by constructive measures.
- Use motors and encoder systems with guaranteed qualities. Your Lenze contact person will inform you about suitable systems.
- This must also be observed in the event of service for the motor or encoder system.

Scaling of position values

The safety module stores the motor encoder and, if necessary, the position encoder position as 32-bit values. The lower-order 16 bits contain the fraction of a motor revolution and the higher-order 16 bits contain the multiple of a motor revolution.

Example	Calculation	Result (hex)
¼ motor revolution	$65536 / 4 = 16384$	0x0000'4000
½ motor revolution	$65536 / 2 = 32768$	0x0000'8000
1 motor revolution	$1 * 65536 = 65536$	0x0001'0000
2 motor revolutions	$2 * 65536 = 131072$	0x0002'0000
2½ motor revolutions	$2 * 65536 + 65536 / 2 = 163840$	0x0002'8000

3.7 Safe inputs

General information

The following applies to the sensors of the SM301, version VA 1.00:

- ▶ The sensor type and function can be parameterised.
- ▶ A local evaluation is carried out if a corresponding parameter setting has been made.
- ▶ If a safety bus is activated, the sensor signals are sent as status information to the master control.
- ▶ Deactivated sensor inputs must not be connected. The status of a non-connected input is in the OFF state.
- ▶ If a signal is detected at a deactivated sensor input during initialisation, the drive remains inhibited ([STO](#)).
- ▶ Faulty inputs are evaluated as OFF state.

The following applies to SM301 from V1.1:

If the "Safe cascading" safety function is active, the safe SD-In4 input is used as a cascading input and can no longer be used as a universal input. For the cascading function, the SD-In4 input must be parameterised as an active input for the "emergency stop" function.

▶ [Cascading \(CAS\)](#) (📖 59)



Note!

Make sure that an internal contact function test is carried out at the safe inputs:

- Safe input in the ON state
 - A LOW level at one channel puts the input in the OFF state. The discrepancy monitoring starts simultaneously.
 - A LOW level must be detected at both channels within the discrepancy time, otherwise a discrepancy error will be reported.
 - To be able to confirm the discrepancy error, a LOW level must be detected before at both channels.
- Safe input in the OFF state
 - A HIGH level at one channel starts the discrepancy monitoring.
 - A HIGH level must be detected at both channels within the discrepancy time, otherwise a discrepancy error will be reported.
 - To be able to confirm the discrepancy error, a HIGH level must be detected before at both channels.



Tip!

Detailed information on the contact function test, the connection of passive/active sensors and example circuits can be found in the manual for the safety module.

Short overview of "Safe inputs" parameter group:

Parameter	Info	Lenze setting	
		Value	Unit
C15030/1...4	SD-In1...4 sensor type	Input is deactivated	
C15031/1...4	SD-In1...4 sensor function	Free assignment	
C15032/1...4	SD-In1...4 free assignment	STO	
C15033/1...4	SD-In1...4 discrepancy time	10	ms
C15034/1...4	SD-In1...4 input delay	0	ms

Sensor type/sensor function

The sensor type and function can be parameterised.



Note!

If an error (e.g. a discrepancy error) occurs at a safe input to which the "operation mode selector" sensor function is assigned, the corresponding input is valued as OFF state.

- By this, standard operation is activated [up to SM301 V1.2](#).
- [From SM301 V1.3](#) the operating mode in the case of LOW level at the safe input can be parameterised via [C15202](#).
- The "Module Error ME" LED blinks, [STO](#) is not tripped.
- Special operation can only be selected again if the error has been eliminated and acknowledged.



Tip!

Detailed information on sensor inputs, active and passive sensors can be found in the manual for the safety module.

Free assignment

If "Free assignment" has been selected as sensor function, the safety function selected via this parameter is assigned to the safe input. The following safety functions can be selected:

- ▶ [Safe torque off \(STO\)](#) (📖 47)
- ▶ [Safe stop 1 \(SS1\)](#) (📖 48)
- ▶ [Safe stop 2 \(SS2\)](#) (📖 49)
- ▶ [Safely limited speed \(SLS\)](#) (📖 54)
- ▶ [Safe direction \(SDI\) \(from SM301 V1.3\)](#) (📖 60)



Note!

If "No function" has been selected, no safety function is assigned to the safe input. The functional test and monitoring of the discrepancy time remain active and the status of the input is transmitted to the control via the safety bus (if parameterised).

Discrepancy time

Maximum time for which both channels of a safe input may have non-equivalent states without the safety system detecting an error.

Input delay

Time between the recognition of the signal change and the effective evaluation of an input signal. As a result, multiple and short signal changes due to contact bounce of the components are not taken into account.

3.8 Safe output

General information

Via the safe output O1A/O1B information can be output to a higher-level unit (e.g. safety PLC) or external switching elements (actuators) can be controlled.

- ▶ The 24V supply of the safety module and the safe output must be provided by safely separated power supply units. In order to keep the circuits electrically isolated, separate voltage supplies are required.
- ▶ The status of the safe output is controlled by two ways:
 - Directly by the safety module through a corresponding setting of the parameters "SD-Out1 switching condition" and "SD-Out1 logic function".
 - Via the PROFIsafe output data in connection with the parameterised "SD-Out1 logic function".
- ▶ The safe output is PP switching, i.e. two plus channels are switched.

The following applies to SM301 from V1.1:

If the "Safe cascading" safety function is active, the safe SD-Out1 output is used as cascading output and cannot be parameterised as a universal feedback output.

▶ [Cascading \(CAS\)](#) (📖 59)



Note!

The safe output is tested cyclically in the ON state by a short LOW switching.

- When selecting the downstream control elements, ensure that the test pulses are not detected as LOW signals.
- These errors are detected immediately and set the output to the OFF state.
 - Short circuit to supply voltage.
 - In the ON state: Short circuit between the output signals.
 - In the ON state: Missing 24-V supply voltage at terminal 24O is detected as "Stuck-at-Low" error.
- These errors are not detected:
 - In the OFF state: Short circuit between the output signals.



Tip!

Detailed information on the functional test by means of test pulses and example circuits can be found in the manual for the safety module.

Short overview of the "Safe output" parameter group:

Parameter	Info	Lenze setting
C15051/1 C15052/1	SD-Out1 switching condition: STO active	Not evaluated
	SD-Out1 switching condition: SS1 active	Not evaluated
	SD-Out1 switching condition: SS2 active	Not evaluated
	SD-Out1 switching condition: SLS1 active	Not evaluated
	SD-Out1 switching condition: SLS2 active *	Not evaluated
	SD-Out1 switching condition: SLS3 active *	Not evaluated
	SD-Out1 switching condition: SLS4 active *	Not evaluated
	SD-Out1 switching condition: SDIpos active **	Not evaluated
	SD-Out1 switching condition: SDIneg active **	Not evaluated
	SD-Out1 switching condition: ES active	Not evaluated
	SD-Out1 switching condition: SLI active ***	Not evaluated
	SD-Out1 switching condition: OMS	Not evaluated
	SD-Out1 switching condition: SOS monitored	Not evaluated
	SD-Out1 switching condition: SLS1 monitored	Not evaluated
	SD-Out1 switching condition: SLS2 monitored *	Not evaluated
	SD-Out1 switching condition: SLS3 monitored *	Not evaluated
	SD-Out1 switching condition: SLS4 monitored *	Not evaluated
	SD-Out1 switching condition: SDIpos monitored **	Not evaluated
	SD-Out1 switching condition: SDIneg monitored **	Not evaluated
	SD-Out1 switching condition: SSE active	Not evaluated
SD-Out1 switching condition: SD-In1 active	Not evaluated	
SD-Out1 switching condition: SD-In2 active	Not evaluated	
SD-Out1 switching condition: SD-In3 active	Not evaluated	
SD-Out1 switching condition: SD-In4 active	Not evaluated	
SD-Out1 switching condition: OMS active	Not evaluated	
SD-Out1 switching condition: Error active	Not evaluated	
C15055/1	SD-Out1 logic function	OR

* From SM301 V1.1 ** From SM301 V1.3 *** From SM301 V1.4

SD-Out1 switching condition

Configuration of the switching conditions that are to be assigned to the safe output.

- ▶ Several switching conditions can be simultaneously assigned to the safe output.
- ▶ For each switching condition it can be individually set whether it is to be evaluated with a positive or negative logic.
- ▶ In order to assign one or several conditions to the safe output, simply change the settings for these conditions from "Not evaluated" to "Positive logic" or "Negative logic".
- ▶ The "SD-Out1" bit of the PROFIsafe output data is included in the evaluation via the selected logic function. The evaluation for this bit can be deactivated via the parameters "S bus: Configuration" and "S bus: Filter control data".

SD-Out1 logic function

Selection of the logic operation (OR or AND) for the switching conditions to be evaluated.



Tip!

- Case studies with regard to the parameter setting of the safe output can be found in the following subchapters.
- [C15060](#) displays the output image of the safety module.

3.8.1 Case study 1: "Safety door"

Switching condition

The following switching condition is to be implemented for the safe output SD-Out1:

- ▶ Opening the safety door is permitted (SD-Out1 in ON state) if
 - the power supply for the motor is safely interrupted (STO active)
 - **OR** special operation is active (OMS active)
 - **OR** the safe operating stop is active and monitored (SOS monitored).

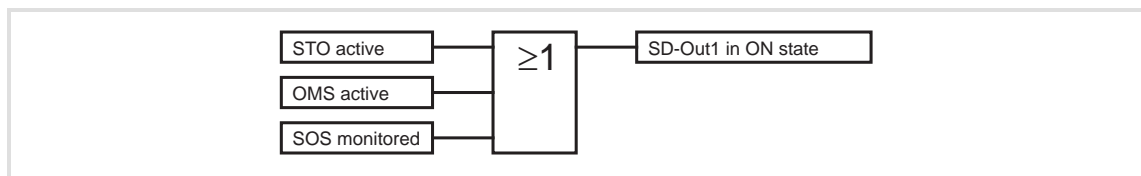

[3-1] Logic operation for "Safety door" case study

Required parameter setting for SD-Out1

1. Set the following switching conditions to "Positive logic":
 - STO active
 - OMS active
 - SOS monitored
2. Set all other switching conditions to "Not evaluated".
3. Set logic function to "OR".
4. If a safety bus has been parameterised:
 - The "SD-Out1" bit of the safety control is considered in the ORing.
 - Hide the "SD-Out1" bit via the "S bus: Filter control data" parameter to suppress this access.

3.8.2 Case study 2: "Signalling"

Switching condition

The following switching condition is to be implemented for the safe output SD-Out1:

- ▶ Safe signalling is carried out (SD-Out1 in ON state) if
 - the power supply for the motor is safely interrupted (STO active)
 - **AND NO** error is active ($\overline{\text{Error active}}$).

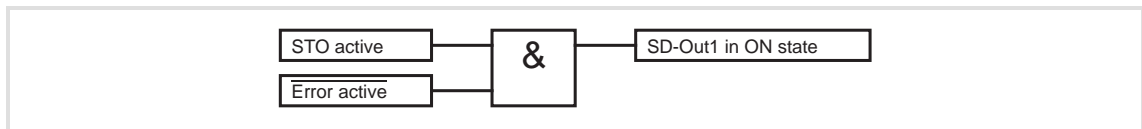

[3-2] Logic operation for case study "Signalling"

Required parameter setting for SD-Out1

1. Set the following switching condition to "Positive logic":
 - STO active
2. Set the following switching condition to "Negative logic":
 - Error active
3. Set all other switching conditions to "Not evaluated".
4. Set logic function to "AND".
5. If a safety bus has been parameterised:
 - The "SD-Out1" bit of the safety control is considered in the ANDing.
 - Hide the "SD-Out1" bit via the "S bus: Filter control data" parameter to suppress this access.

3.9 Safety functions

The parameterisable safety functions are divided into five functional subgroups:

- ▶ [Safe stop](#)
- ▶ [Safe speed limitation](#) (📖 52)
- ▶ [Operation mode selection](#) (📖 56)
- ▶ [Cascading \(CAS\)](#) (from SM301 V1.1) (📖 59)
- ▶ [Safe direction](#) (from SM301 V1.3) (📖 60)

3.9.1 Safe stop

General information

The stop functions are divided according to the tripping reason:

- ▶ Standard stop (simple stop)
 - Tripping by a safe input with the parameterised functions STO, SS1, or SS2*.
 - Tripping by activating the bits STO, SS1 or SS2* via the safety bus.
 - In special operation (OMS) the standard stop can be avoided by confirming it with the enable switch (ES).
- ▶ Emergency stop
 - Tripping by a safe input with the parameterised function SSE.
 - Tripping by activating the bit SSE via the safety bus.
 - STO or SS1 can be set as the function to be executed via the parameter "SSE: Emergency stop function".
 - In special operation (OMS) the emergency stop cannot be avoided.
- ▶ Error stop
 - Tripping as response to an error.
 - In special operation (OMS) the error stop cannot be avoided.

* Based on EN 61800-5-2 / SOS is speed-monitored ([up to SM301 V1.2](#)) and based on the EN 61800-5-2 standard / SOS is position-monitored ([from SM301 V1.3](#))

Short overview of "Safety functions → Safe stop" parameter group:

Parameter	Info	Lenze setting	
		Value	Unit
C15205	SSE: Emergency stop function	STO	
C15300/1	Restart behaviour - STO, SS1	Acknowledged restart	
C15300/2	Restart behaviour - SS2, SOS	Acknowledged restart	
C15305	SS1, SS2: Stopping time	0	ms
C15306	SS1 mode *	STO after stopping time	
C15307	SS1: STO delay after n=0 *	0	ms
C15308	SS2 mode *	SOS after stopping time	
C15310	Speed window (n=0)	0	rpm
C15311	SOS: Tolerance margin (delta p=0) *	0	inc
C15315	SS1, SS2: Ramp monitoring **	Ramp monitoring activated	
C15316	SS1, SS2: Ramp - S-ramp time **	0	%
C15317	SS1, SS2: Ramp - start-offset **	0	%

* From SM301 V1.3 ** From SM301 V1.4

3.9.1.1 Priorisation

Stop functions with priority influence the process of already started subordinated functions.

1. [Safe torque off \(STO\)](#)

- The STO function has the highest priority and thus takes priority over all other functions. Functions already started (e.g. SS1 or SS2) are cancelled and the drive is switched off.

2. [Safe stop 1 \(SS1\)](#)

- The SS1 function has priority over SS2. Taking the stopping time set for SS1 and SS2 and for the SS1 mode ([from SM301 V1.3](#)) into consideration, the drive is switched to torque-free operation.

3. Monitoring functions

- The monitoring functions have the same priorities. They can also be executed parallel to the stop function.

3.9.1.2 Restart behaviour

The restart behaviour of the drive after a stop function has been executed can be set via the following parameters:

- ▶ "Restart behaviour - STO, SS1" ([C15300/1](#))
- ▶ "Restart behaviour - SS2, SOS" ([C15300/2](#))



Danger!

If the request for the safety function is cancelled, the drive can restart automatically.

In the case of an automatic restart, you have to provide external measures which ensure that the drive only restarts after a confirmation (EN 60204).

Restart behaviour in the case of the "Acknowledged restart" setting

- ▶ After a standard stop the restart must be acknowledged (AIS) via terminal or safety bus.
- ▶ After an error stop, the error must be acknowledged first (AIE), before the restart is acknowledged with AIS.

Acknowledgement	via terminal	via safety bus
AIS	X82.3 or X82.4 (Positive signal pulse with a signal duration of 0.3 ... 10 s)	PROFIsafe bit "PS_AIS" (positive edge) ▶ Safety bus (□ 61)
AIE	X82.2 (Positive signal pulse with a signal duration of 0.3 ... 10 s)	PROFIsafe bit "PS_AIE" (positive edge) ▶ Safety bus (□ 61)



Note!

The restart behaviour after an emergency stop corresponds to the restart behaviour parameterised for the STO/SS1 stop function.

Restart behaviour in the case of the "Automatic restart" setting

The higher-level control must ensure that the drive only restarts after an acknowledgement. The stop status of the drive is reported to the higher-level control via bit STO or SOS.

The following applies to SM301 from V1.1:

If the "Safe cascading" safety function is active, an automatic restart after STO is not permissible. The plausibility check rejects such a setting. ▶ [Cascading \(CAS\)](#) ([□ 59](#))

3.9.1.3 Emergency stop function (SSE)

Description	Safe Stop Emergency / SSE The emergency stop function starts STO or SS1 , depending on the setting of the "SSE: emergency stop function" parameter.
	<ul style="list-style-type: none"> In special operation the emergency stop cannot be avoided. Connect the emergency stop buttons, which must not be overruled by special operation, to the emergency stop function. For this purpose, parameterise the safe input as "emergency stop" (C15031).
Parameter	C15205 SSE: Emergency stop function <ul style="list-style-type: none"> Selection of the function to be performed (STO or SS1).
Activation	How to activate the function: <ul style="list-style-type: none"> A data telegram with a corresponding content is sent to the controller via the safety bus. <ul style="list-style-type: none"> ▶ Safety bus (61) "OFF state" at a safe input which has been assigned to the function by parameter setting. <ul style="list-style-type: none"> ▶ Safe inputs (37)

3.9.1.4 Safe torque off (STO)

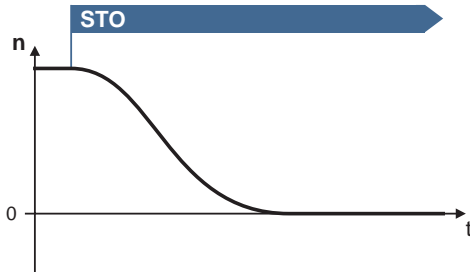
Description	Safe Torque Off / STO (corresponds to a "Stop 0" in accordance with EN 60204) By using this function the power supply for the motor is safely interrupted immediately. The motor cannot generate a torque and thus no dangerous motions of the drive.
	<ul style="list-style-type: none"> Additional measures are required against movements caused by external forces, e.g. mechanical brakes. The restart behaviour can be set. ▶ Restart behaviour (46)
Priority	Priority function: none Subordinated function: SS1 , SS2
Function	
Parameter	Function sequence and error response have no adjustable parameters.
Activation	How to activate the function: <ul style="list-style-type: none"> A data telegram with a corresponding content is sent to the controller via the safety bus. <ul style="list-style-type: none"> ▶ Safety bus (61) "OFF state" at a safe input which has been assigned to the function by parameter setting. <ul style="list-style-type: none"> ▶ Safe inputs (37) As response to the error stop request. As response to the emergency stop request.

SM301 safety module | Parameter setting & configuration

Safe configuration

Safety functions | Safe stop

3.9.1.5 Safe stop 1 (SS1)

Description	<p>Safe Stop 1 / SS1 (corresponds to a "Stop1" according to EN 60204) The safety module monitors whether the drive has reached the set tolerance margin ($n=0$) within the parameterised stopping time and, depending on the parameterised SS1 mode, after the stopping time has elapsed or after falling below the tolerance margin ($n=0$), switches the drive to torque-free operation via the STO safety function.</p>	
	<ul style="list-style-type: none"> From SM301 V1.4 additionally the deceleration ramp for the SS1 stop function can be parameterised and monitored. ▶ Ramp monitoring (SS1/SS2) (□ 51) The drive must be braked through the application! The speed is calculated from the encoder data. ▶ Safe speed measurement and position detection (□ 34) In SS1 mode "STO with $n=0$", you can use the parameter "STO delay after $n=0$" to set a waiting time which determines when the STO status is adopted. Without an encoder, the function evaluates the speed status $n=0$ of the controller. In this case the stopping time monitored by the safety module must be 0.5 s longer than the stopping time parameterised on the controller. Additional measures are required against movements caused by external forces, e.g. mechanical brakes. The application time of a brake must be considered when determining the stopping time. A restart is only possible after the stopping time has elapsed completely. This does not apply to special operation. ▶ Restart behaviour (□ 46) 	
Priority	Priority function: STO Subordinated function: SS2	
Function	<p>From SM301 V1.3, function □ (STO with $n=0$) can be selected as SS1 mode.</p>	
Parameter	C15306 ① C15305 ② C15307 ③ C15310	SS1 mode: <input type="checkbox"/> □ STO after stopping time <input type="checkbox"/> □ STO with $n=0$ SS1, SS2: Stopping time SS1: STO delay after $n=0$ Speed window ($n=0$)
Activation	How to activate the function: <ul style="list-style-type: none"> A data telegram with a corresponding content is sent to the controller via the safety bus. ▶ Safety bus (□ 61) "OFF state" at a safe input which has been assigned to the function by parameter setting. ▶ Safe inputs (□ 37) As response to the error stop request. As response to the emergency stop request. 	
Normal behaviour	When the stopping time has elapsed or after falling below the tolerance margin ($n=0$), a standard stop is activated. <ul style="list-style-type: none"> The power supply for the motor is safely interrupted immediately (STO). The motor cannot generate a torque and thus no dangerous movements of the drive. 	
Error behaviour	If standstill has not been reached when the stopping time has elapsed, or if the deceleration ramp parameterised was exceeded during the Ramp monitoring was activated, an error message is triggered and an error stop is activated. <ul style="list-style-type: none"> The power supply for the motor is safely interrupted immediately (STO). The motor cannot generate a torque and thus no dangerous movements of the drive. 	

3.9.1.6 Safe stop 2 (SS2)



Note!

When the stopping time has elapsed, the safe stop 2 (SS2) function switches to the safe operating stop (SOS). This function has been implemented in the SM301 up to version V1.2 in the form of speed range monitoring.

- This means that the SOS function and, consequently, also the SS2 function have not been implemented in accordance with the IEC 61800-5-2 standard, which clearly requires the monitoring of a position window in section 4.2.3.1.

From SM301 V1.3

- position-window monitoring has been implemented.
- it is possible to change to the safe operating stop before the stopping time has elapsed as soon as the standstill has been identified. This behaviour can be parameterised.

Description	<p>Safe Stop 2 / SS2 (corresponds to a "Stop 2" in accordance with EN 60204)</p> <p>The safety module monitors whether the drive has reached the set tolerance margin (n=0) within the parameterised stopping time and, depending on the parameterised SS2 mode, after the stopping time has elapsed or after falling below the tolerance margin (n=0), activates the monitoring of the safe operating stop (SOS).</p> <p>In the safe operational stop the drive is not switched to torque-free operation but all control functions remain active and the position reached must be maintained actively.</p>
	<ul style="list-style-type: none"> • From SM301 V1.4 additionally the deceleration ramp for the SS2 stop function can be parameterised and monitored. ▶ Ramp monitoring (SS1/SS2) (□ 51) • The application must ensure that the drive is braked to standstill and the position is maintained! • The speed and the position data are calculated from the encoder data. ▶ Safe speed measurement and position detection (□ 34) • Without an encoder the function cannot be used. • Additional measures are required against movements caused by external forces, e.g. mechanical brakes. The application time of a brake must be considered when determining the stopping time. • A restart is only possible after the stopping time has elapsed completely. This does not apply to special operation. ▶ Restart behaviour (□ 46)
Priority	<p>Priority functions: STO, SS1</p>

SM301 safety module | Parameter setting & configuration



Safe configuration

Safety functions | Safe stop

<p>Function</p>	<p>From SM301 V1.3, function B (SOS with $n=0$) can be selected as SS2 mode.</p>								
<p>Parameter</p>	<table border="1"> <tr> <td>C15308</td> <td>SS2 mode: A SOS after stopping time B SOS with $n=0$</td> </tr> <tr> <td>1 C15305</td> <td>SS1, SS2: Stopping time</td> </tr> <tr> <td>2 C15310</td> <td>Speed window ($n=0$)</td> </tr> <tr> <td>3 C15311</td> <td>SOS: Tolerance margin ($\Delta p=0$) *</td> </tr> </table>	C15308	SS2 mode: A SOS after stopping time B SOS with $n=0$	1 C15305	SS1, SS2: Stopping time	2 C15310	Speed window ($n=0$)	3 C15311	SOS: Tolerance margin ($\Delta p=0$) *
C15308	SS2 mode: A SOS after stopping time B SOS with $n=0$								
1 C15305	SS1, SS2: Stopping time								
2 C15310	Speed window ($n=0$)								
3 C15311	SOS: Tolerance margin ($\Delta p=0$) *								
<p>Activation</p>	<p>How to activate the function:</p> <ul style="list-style-type: none"> A data telegram with a corresponding content is sent to the controller via the safety bus. <ul style="list-style-type: none"> Safety bus (☞ 61) "OFF state" at a safe input which has been assigned to the function by parameter setting. <ul style="list-style-type: none"> Safe inputs (☞ 37) As response to the error stop request. 								
<p>i</p>	<p>In the SOS state, relative position changes are added and compared with the permissible value in the parameter "Tolerance margin $\Delta p=0$".</p> <ul style="list-style-type: none"> When the SOS state is left, the maximum relative position change is displayed in the parameter C15312. When the SOS state is requested again, the sum of the last position changes is reset to zero. <p>Example</p> <p>The "SS2 active" state and the "SOS active" state are interrupted by an STO request. If the STO request is reset, the status immediately changes to SOS. This leads to a reset of the current position deviation to $p=0$.</p>								
<p>Normal behaviour</p>	<p>When the stopping time has elapsed or after falling below the tolerance margin ($n=0$), the monitoring of the safe operating stop (SOS) becomes active.</p>								
<p>Error behaviour</p>	<p>If standstill has not been reached when the stopping time has elapsed, or if the deceleration ramp parameterised was exceeded during the Ramp monitoring was activated, an error message is triggered and an error stop is activated.</p> <ul style="list-style-type: none"> The power supply for the motor is safely interrupted immediately (STO). The motor cannot generate a torque and thus no dangerous movements of the drive. <p>Safe operating stop (SOS) in final state:</p> <p>If the speed gets out off the set tolerance margin ($n=0$ or $\Delta p=0$) during a safe operational stop, an error message is generated and an error stop starts.</p> <ul style="list-style-type: none"> The power supply for the motor is safely interrupted immediately (STO). The motor cannot generate a torque and thus no dangerous movements of the drive. 								

3.9.1.7 Ramp monitoring (SS1/SS2)

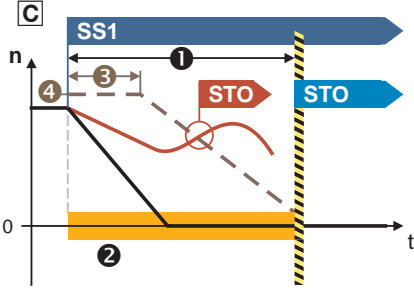
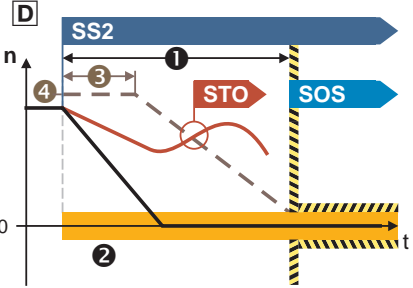
From SM301 V1.4

Description	<p>The SS1 and SS2 stop functions monitor whether the drive has reached the set tolerance window ($n=0$) within the stopping time parameterised.</p> <p>From SM301 V1.4 additionally the deceleration ramp for the SS1 and SS2 stop functions can be parameterised and monitored.</p> <p>By monitoring the deceleration process, safety can be increased. The longer the deceleration times due to high moments of inertia are, the more important is ramp monitoring, in order to still be able to ensure acceptable safety margins.</p>															
	<ul style="list-style-type: none"> The application must ensure that the drive is braked to standstill and the position is maintained! The safe speed evaluation is a precondition for safe ramp monitoring, i. e. an encoder system has to be parameterised in the safety module. ▶ Safe speed measurement and position detection (□ 34) If ramp monitoring is activated, the starting value of the ramp and the S-ramp time have to be preselected as a percentage value. <ul style="list-style-type: none"> –The starting value refers to the current speed value at the time of the SS1/SS2 request. –Via the S-ramp time, the starting time of the deceleration ramp is delayed to take a potential S-ramp smoothing into consideration. 															
Function	  <p>Safe ramp monitoring for SS1 (C) and SS2 (D)</p>															
Parameter	<table border="1"> <tr> <td>①</td> <td>C15305</td> <td>SS1, SS2: Stopping time</td> </tr> <tr> <td>②</td> <td>C15310</td> <td>Speed window ($n=0$)</td> </tr> <tr> <td></td> <td>C15315</td> <td>SS1, SS2: Ramp monitoring</td> </tr> <tr> <td>③</td> <td>C15316</td> <td>SS1, SS2: Ramp S-ramp time</td> </tr> <tr> <td>④</td> <td>C15317</td> <td>SS1, SS2: Ramp offset start</td> </tr> </table>	①	C15305	SS1, SS2: Stopping time	②	C15310	Speed window ($n=0$)		C15315	SS1, SS2: Ramp monitoring	③	C15316	SS1, SS2: Ramp S-ramp time	④	C15317	SS1, SS2: Ramp offset start
①	C15305	SS1, SS2: Stopping time														
②	C15310	Speed window ($n=0$)														
	C15315	SS1, SS2: Ramp monitoring														
③	C15316	SS1, SS2: Ramp S-ramp time														
④	C15317	SS1, SS2: Ramp offset start														
Activation	<p>How to activate the function:</p> <ul style="list-style-type: none"> The ramp monitoring function has to be activated via parameter C15315. If the SS1/SS2 stop function is requested, a monitoring ramp is calculated and is layed on the current speed characteristic. 															
	<ul style="list-style-type: none"> The parameterisation of the monitoring ramp in the safety module has to take the parameters of the deceleration ramp from the application into consideration. On the basis of the actual speed, a parameterisable percentage proportion (0 ... 30 %) is added to the actual speed as start offset and is considered as a constant starting value. <ul style="list-style-type: none"> –In the Lenze setting of the start offset (C15317) the tolerance window ($n=0$) is considered as the offset. The monitoring ramp is only started after an internal deceleration time has elapsed, which is generated depending on the "SS1, SS2: S-ramp time" and "SS1, SS2: Stopping time" parameters: <ul style="list-style-type: none"> –The "SS1, SS2: S-ramp time" parameter is scaled linearly from 10 ... 30 % to the stopping time: <ul style="list-style-type: none"> 0 % S-ramp time \equiv 10 % deceleration 100 % S-ramp time \equiv 30 % deceleration –In the Lenze setting of the S-ramp time, the deceleration time is 10 % of the stopping time set. –In the SM301 the same value as in the standard device can be set for the S-ramp time. 															

SM301 safety module | Parameter setting & configuration

Safe configuration

Safety functions | Safe speed limitation

Normal behaviour	During the stopping time elapses, or before the tolerance window (n=0) is reached, the speed ramp parameterised is not exceeded. Afterwards there is the transition to the STO or SOS stop function parameterised.
Error behaviour	<p>If the current speed exceeds the parameterised speed ramp within the stopping time or before the tolerance window (n=0) is reached, an error message is triggered and an error stop is activated.</p> <ul style="list-style-type: none"> The power supply for the motor is safely interrupted immediately (STO). The motor cannot generate a torque and thus no dangerous movements of the drive.

3.9.2 Safe speed limitation

The SM301 supports the safe monitoring of a maximum speed (SMS), which is active for all operating states. Furthermore the monitoring of a safely limited speed (SLS1) can be activated via a safe input or the safety bus.

From SM301 V1.1 onwards, the following safety functions are additionally supported:

- ▶ Safely limited speed 2 (SLS2)
- ▶ Safely limited speed 3 (SLS3)
- ▶ Safely limited speed 4 (SLS4)

Short overview of "Safety functions → Safe speed" parameter group:

Parameter	Info	Lenze setting	
		Value	Unit
C15320	SMS: Max. speed Nmax	1	rpm
C15321	SMS: Reaction (n>Nmax)	SS1	
C15330/1	SLS1: Limited speed Nlim1	0	rpm
C15331/1	SLS1: Braking time Nlim1	0	ms
C15332/1	SLS1: Response (n>Nlim1)	SS1	
C15333/1	SLS1: Perm. direction of movement ***	Both directions enabled	
C15330/2	SLS2: Limited speed Nlim2 *	0	rpm
C15331/2	SLS2: Braking time Nlim2 *	0	ms
C15332/2	SLS2: Reaction (n>Nlim2) *	SS1	
C15333/2	SLS2: Perm. direction of movement ***	Both directions enabled	
C15330/3	SLS3: Limited speed Nlim3 *	0	rpm
C15331/3	SLS3: Braking time Nlim3 *	0	ms
C15332/3	SLS3: Reaction (n>Nlim3) *	SS1	
C15333/3	SLS3: Perm. direction of movement ***	Both directions enabled	
C15330/4	SLS4: Limited speed Nlim4 *	0	rpm
C15331/4	SLS4: Braking time Nlim4 *	0	ms
C15332/4	SLS4: Reaction (n>Nlim4) *	SS1	
C15333/4	SLS4: Perm. direction of movement ***	Both directions enabled	

* From SM301 V1.1

** From SM301 V1.2

*** From SM301 V1.3

Parameter	Info	Lenze setting	
		Value	Unit
C15350	SLS, SMS: Max. response time	0	ms
C15410	Response time encoder monitoring **	12	ms
C15411	Speed comparison tolerance ***	20	rpm

* From SM301 V1.1 ** From SM301 V1.2 *** From SM301 V1.3

3.9.2.1 Safe maximum speed (SMS)

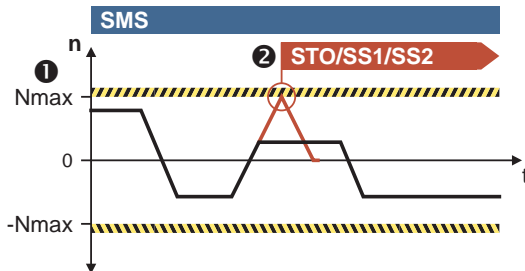

Description	Safe Maximum Speed / SMS The safety module monitors the adjusted safe maximum speed of the motor.	
	The function can only be activated by parameter setting. <ul style="list-style-type: none"> See parameter "SMS: Maximum speed Nmax". The function must not be parameterised if "No encoder system" is set. The plausibility check rejects such implausible settings until they have been parameterised correctly. 	
Function		
Parameter	1 C15320	SMS: Max. speed Nmax <ul style="list-style-type: none"> A value > 0 activates the function, a value = 0 deactivates the function.
	2 C15321	SMS: Reaction ($n > N_{max}$) <ul style="list-style-type: none"> Selection of the function to be executed (STO, SS1 or SS2) if monitoring responds.
	C15350	SLS, SMS: Max. response time <ul style="list-style-type: none"> If in the event of an error the speed is still outside the limit values after the response time has elapsed, STO is tripped immediately. Detailed information can be found in the chapter "Error analysis for the functions SMS and SLS". (p. 55)
Activation	How to activate the function: <ul style="list-style-type: none"> Set the parameter "SMS: Maximum speed Nmax" > 0. 	
Error behaviour	If the speed exceeds the set maximum speed Nmax, an error message is generated and an error stop is started with the function set in the parameter "SMS: Reaction ($n > N_{max}$)" (STO , SS1 or SS2).	

SM301 safety module | Parameter setting & configuration

Safe configuration

Safety functions | Safe speed limitation

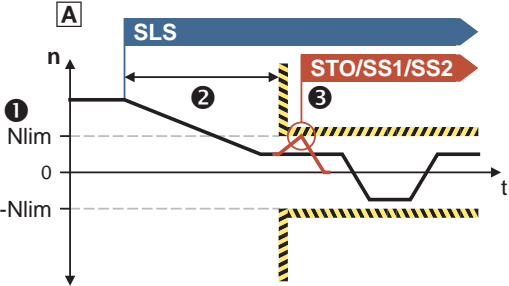
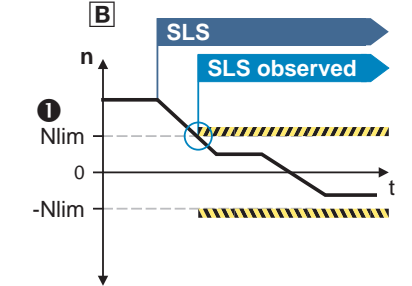
3.9.2.2 Safely limited speed (SLS)

Description	<p>Safely-Limited Speed / SLS</p> <p>When the value has fallen below the parameterised speed limit N_{lim} or, at the latest, after the adjustable braking time has elapsed, the safety module monitors that the set limited speed N_{lim} is not exceeded.</p>														
	<ul style="list-style-type: none"> The drive must be braked to the limited speed through the application! For operation within the limit values the "SLS1...4 monitored" status is set (C15000). <ul style="list-style-type: none"> The status can be assigned to the safe output as a safe speed monitor. ▶ Safe output (40) The status can also be reported via the safety bus. The function must not be parameterised if "No encoder system" is set. The plausibility check rejects such implausible settings until they have been parameterised correctly. The limited speeds SLS2 ... SLS4 are available from SM301 V1.1! From SM301 V1.3 you can set both the limited speed and, in addition, the permissible direction of movement via a parameter. When the direction monitoring SDIxxx is combined with the SLSx function, the delay times must be adapted to each other. The braking time N_{lim} then starts at the same time as the SDI delay time. 														
Function	<div style="display: flex; justify-content: space-around;"> <div data-bbox="507 786 1018 1070">  </div> <div data-bbox="1026 786 1439 1070">  </div> </div> <p>Function  (monitoring is active before the braking time has elapsed) only from SM301 V1.3</p>														
Parameter	<table border="1"> <tr> <td data-bbox="507 1126 678 1160">① C15330/1...4</td> <td data-bbox="686 1126 1439 1160">SLS1...4: Limited speed N_{lim}</td> </tr> <tr> <td data-bbox="507 1162 678 1196">② C15331/1...4</td> <td data-bbox="686 1162 1439 1196">SLS1...4: Braking time N_{lim}</td> </tr> <tr> <td data-bbox="507 1198 678 1232">③ C15332/1...4</td> <td data-bbox="686 1198 1439 1232">SLS1...4: Reaction ($n > N_{lim}$)</td> </tr> <tr> <td data-bbox="507 1234 678 1285"></td> <td data-bbox="686 1234 1439 1285"> <ul style="list-style-type: none"> Selection of the function to be executed (STO, SS1 or SS2) if monitoring responds. </td> </tr> <tr> <td data-bbox="507 1288 678 1321">C15333/1...4</td> <td data-bbox="686 1288 1439 1321">SLS1...4: Perm. direction of movement</td> </tr> <tr> <td data-bbox="507 1323 678 1357">C15350</td> <td data-bbox="686 1323 1439 1357">SLS, SMS: Max. response time</td> </tr> <tr> <td data-bbox="507 1359 678 1469"></td> <td data-bbox="686 1359 1439 1469"> <ul style="list-style-type: none"> If in the event of an error the speed is still outside the limit values after the response time has elapsed, STO is tripped immediately. Detailed information can be found in the chapter "Error analysis for the functions SMS and SLS". (45) </td> </tr> </table>	① C15330/1...4	SLS1...4: Limited speed N_{lim}	② C15331/1...4	SLS1...4: Braking time N_{lim}	③ C15332/1...4	SLS1...4: Reaction ($n > N_{lim}$)		<ul style="list-style-type: none"> Selection of the function to be executed (STO, SS1 or SS2) if monitoring responds. 	C15333/1...4	SLS1...4: Perm. direction of movement	C15350	SLS, SMS: Max. response time		<ul style="list-style-type: none"> If in the event of an error the speed is still outside the limit values after the response time has elapsed, STO is tripped immediately. Detailed information can be found in the chapter "Error analysis for the functions SMS and SLS". (45)
① C15330/1...4	SLS1...4: Limited speed N_{lim}														
② C15331/1...4	SLS1...4: Braking time N_{lim}														
③ C15332/1...4	SLS1...4: Reaction ($n > N_{lim}$)														
	<ul style="list-style-type: none"> Selection of the function to be executed (STO, SS1 or SS2) if monitoring responds. 														
C15333/1...4	SLS1...4: Perm. direction of movement														
C15350	SLS, SMS: Max. response time														
	<ul style="list-style-type: none"> If in the event of an error the speed is still outside the limit values after the response time has elapsed, STO is tripped immediately. Detailed information can be found in the chapter "Error analysis for the functions SMS and SLS". (45) 														
Activation	<p>How to activate the function:</p> <ul style="list-style-type: none"> A data telegram with a corresponding content is sent to the controller via the safety bus. <ul style="list-style-type: none"> ▶ Safety bus (61) "OFF state" at a safe input which has been assigned to the function by parameter setting. <ul style="list-style-type: none"> ▶ Safe inputs (37) 														
Error behaviour	<p>If the speed exceeds the set limited speed N_{lim} in the monitored state, an error message is generated and an error stop is triggered with the function set in the parameter "SLS1...4: Reaction ($n > N_{lim}$)" (STO, SS1 or SS2).</p>														

3.9.2.3 Error analysis for the functions SMS and SLS

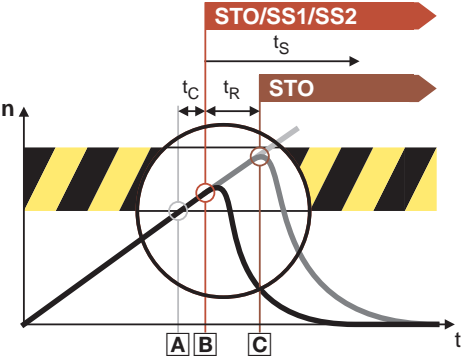
<p>Error analysis</p>	<p>The speed values are evaluated and checked for plausibility in a cycle of 2 ms. The following illustration shows the process from the moment the error occurred.</p> 
	<p>A Occurrence of the error event</p> <ul style="list-style-type: none"> The speed exceeds the limit value parameterised for SMS or SLS.
	<p>B Detection of the error event</p> <ul style="list-style-type: none"> After the internal response time t_c of max. one evaluation cycle has elapsed, the parameterised function (STO, SS1 or SS2) is started as the error response. With the parameterised function SS1 or SS2, the stopping time t_s set for SS1/SS2 is added to the internal response time, until STO is started in the event of an error.
	<p>C Response instance in the case of continuous exceedance</p> <ul style="list-style-type: none"> By parameterising the maximum response time t_r (C15350), continuous exceedance of the limit values can be avoided. If the speed is outside the limit values even after the response time t_r has elapsed, STO is started immediately.
<p>i</p>	<p>In the event of an error, the set limited speed will be exceeded. In order to evaluate the risk for the system, you must calculate the amount of the maximum exceedance. The following must be taken into account:</p> <ul style="list-style-type: none"> Internal response time Application-specific response time Application-specific maximum acceleration



3.9.3 Operation mode selection



Short overview of "Safety functions → Operation mode selection" parameter group:

Parameter	Info	Lenze setting	
		Value	Unit
C15200	OMS: Stop function	STO	
C15201	OMS: Motion function	SLS1	
C15202	OMS: Function at LOW level *	Standard operation	
C15203	Safely limited increment **	1	inc

* From SM301 V1.3 ** From SM301 V1.4

3.9.3.1 Operation mode selector (OMS)

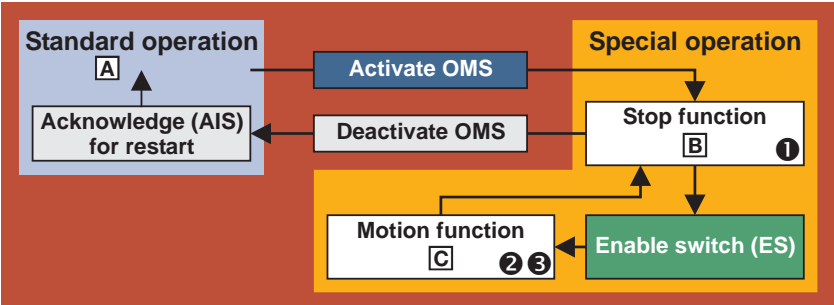
Description	<p>Operation Mode Selector / OMS</p> <p>This function serves to switch between standard operation and "special operation" of the drive.</p>
	<ul style="list-style-type: none"> Special operation enables the overriding of a standard stop (STO, SS1 and SS2) by release through the enable switch. ▶ Enable switch (ES) (□ 58) From SM301 V1.4: The monitoring function of the safely limited increment is active as soon as a value > 0 has been entered in C15203. The setting "0" deactivates the SLI monitoring function. The monitoring function parameterised is automatically activated with the transition to special operation. A motion function other than "traverse freely" at the same time is monitoring function in special operation.
	<p>OMS: Function at LOW level</p> <p>If the operation mode selector is implemented via a safe input, the operating mode for the LOW level is to be selected with care (from SM301 V1.3).</p> <p>According to the closed-circuit principle, no additional danger must be caused by standard or special operation in the corresponding application.</p> <p>For detailed information, please see the manual for the safety module.</p>
Conditions	<ul style="list-style-type: none"> A safe input must be parameterised and interconnected as an operation mode selector. You can only connect and parameterise one operation mode selector. The OMS bit of the safety bus must be deactivated (C15113). When a safe input is used, the LOW level function must be set depending on the application (from SM301 V1.3). Special operation can also be selected via the safety bus with the OMS bit unless a safety input is set as an operation mode selector. The plausibility check rejects ambiguous settings until you have parameterised them correctly.

<p>Function</p>		
	<p>A</p>	<p>Basic status of standard operation</p>
	<p>B</p>	<p>If special operation is requested, the stop function (STO, SS1 or SS2) parameterised for special operation is started.</p>
	<p>C</p>	<p>Via enable through the enable switch, the motion function (SLS or free traversing) parameterised for special operation is possible. Furthermore the SLI monitoring function (safely limited increment) can be switched on for the motion function parameterised.</p>
<p>Parameter</p>	<p>1 C15200</p>	<p>OMS: Stop function</p>
	<p>2 C15201</p>	<p>OMS: Motion function</p> <ul style="list-style-type: none"> The "Free traversing" setting must be suitable for the application!
	<p>C15202</p>	<p>OMS: Function at LOW level</p>
	<p>3 C15203</p>	<p>Safely limited increment</p>
<p>Requesting the special operation</p>	<p>How to request the special operation:</p> <ul style="list-style-type: none"> "ON state" at a safe input to which the "operation mode selector" function has been assigned by parameter setting. ▶ Safe inputs (□ 37) Only if no safe input is used, the function can be activated via the safety bus by sending a data telegram with a corresponding content to the controller. 	
<p> Deactivating special operation</p>	<p>If the OMS bit is received via the safety bus, the value 0 (standard operation) is adopted in the case of passivation. In special applications (e.g. safety door requests OMS, i.e. open safety door = special operation), this must not lead to a dangerous state through an automatic restart!</p> <p>A change-over from special operation to standard operation is only possible when the drive is at standstill (stop function STO, SS1 or SS2 active).</p> <ul style="list-style-type: none"> For a restart, the restart must be acknowledged (AIS) via terminal or safety bus. The automatic restart is not permitted. If the "Automatic restart" is parameterised, this must be prevented by special measures, e.g. programming in the master control. 	
<p>Error behaviour</p>	<ul style="list-style-type: none"> The monitoring functions SMS and SLS can be activated in both operating modes and trigger the parameterised stop function in the event of an error. If the SLI monitoring function is active, exceeding the position window activates the parameterised stop function for special operation. The emergency stop function can be triggered in both operating modes. 	

3.9.3.2 Enable switch (ES)

Description	Enable Switch / ES This function enables overriding of the standard stop functions STO , SS1 and SS2 during special operation.
	A release via the enable switch activates the parameterised motion function during special operation and the drive can be traversed. The stopping times assigned to the stop functions are directly deactivated/stopped.
Conditions	<ul style="list-style-type: none">• A safe input must be parameterised and interconnected as an enable switch. You can only connect and parameterise one enable switch. The ES bit of the safety bus must be deactivated (C15113).• The confirmation can also be selected via the safety bus using the ES bit unless a safe input is set as an enable switch.• Special operation must be activated. ▶ Operation mode selector (OMS) (📖 56)• The plausibility check rejects ambiguous settings until you have parameterised them correctly.
Activation	How to activate the function: <ul style="list-style-type: none">• "ON state" at a safe input to which the "enable switch" function has been assigned by parameter setting. ▶ Safe inputs (📖 37)• Only if no safe input is used, the function can be activated via the safety bus by sending a data telegram with a corresponding content to the controller.

3.9.4 Cascading (CAS)

From SM301 V1.1

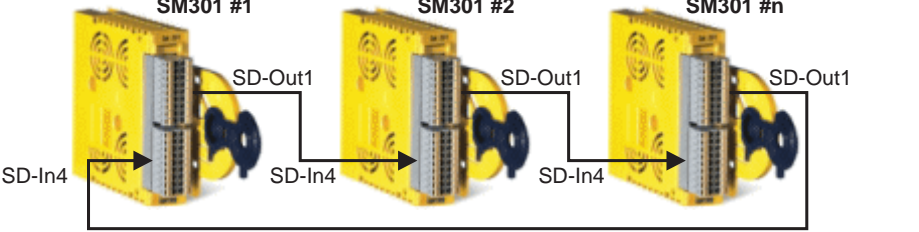
Description	Cascading / CAS This function enables the synchronised shutdown of an entire drive system.	
	<ul style="list-style-type: none"> The function can only be activated via parameter setting. See parameter "CAS: Cascading". When the function is active: <ul style="list-style-type: none"> The safe SD-In4 input is used as a cascading input and can no longer be used as universal input. The safe SD-Out1 output is used as a cascading output and can no longer be parameterised as universal feedback output. An emergency stop function (SSE) tripped by cascading cannot be overridden by the Enable switch (ES) during special operation. The cascade triggers with every STO, independently of which safety module has the STO status and for what reason. All safety modules of the cascade can only be enabled if <u>all</u> cascading inputs (SD-In4) are in the OFF state. 	
Conditions	<ul style="list-style-type: none"> The SD-In4 input must be parameterised as an active input for the "emergency stop" function and the input delay for SD-In4 must be ≤ 10 ms. ▶ Safe inputs (□ 37) Via the "SSE: Emergency stop function" parameter, STO must be parameterised as the emergency stop function to be executed. ▶ Emergency stop function (SSE) (□ 47) The restart behaviour following the execution of the STO/SS1 stop function must be parameterised to "acknowledged restart". ▶ Restart behaviour (□ 46) The control of the SD-Out1 output via a parameterised safety bus must be inhibited. ▶ Safety bus (□ 61) The plausibility check rejects other settings until you have parameterised them correctly. In the cascade connection, you can only change from the SS2/SOS stop function to the confirmation during special operation. The STO/SS1 stop function would always trigger the interconnection and a confirmation would thus not be possible. 	
Principle		
Parameter	C15035	CAS: Cascading
	C15036	CAS: Stop delay <ul style="list-style-type: none"> Display of the time that passes between switching of the SD-Out1 output to the OFF state and the detection of the OFF state at the SD-In4 input. This information can be helpful when commissioning/maintaining the system. If "0 ms" is displayed after a stop, another safety module has triggered the stop via the cascade. The time that passes until the next system acknowledgement is displayed.
Activation	How to activate the function: <ul style="list-style-type: none"> Set "CAS: Cascading" parameter to "cascading with SD-In4". 	



Tip!

Detailed information on cascade wiring can be found in the manual for the safety module.



SM301 safety module | Parameter setting & configuration

Safe configuration

Safety functions | Safe direction (SDI)

3.9.5 Safe direction (SDI)

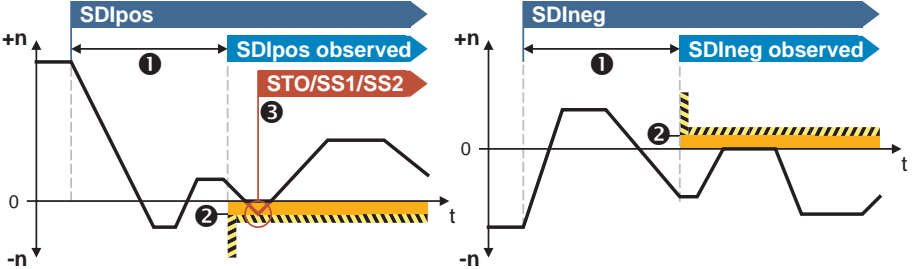
From SM301 V1.3

Description	Safe Direction / SDI This function allows you to monitor a direction. The safety module monitors whether the drive reaches the set direction in the parameterised delay time and, after the delay time has elapsed, indicates that the direction is monitored. In the monitoring phase, a tolerance threshold ensures that the drive does not leave the permissible direction.	
	<ul style="list-style-type: none"> The direction must be observed by the application! For operation within the limit values the "SDIpos/SDIneg monitored" status is set (C15000). <ul style="list-style-type: none"> The status can be assigned to the safe output. ▶ Safe output (☞ 40) The status can also be reported via the safety bus. The function must not be parameterised if "No encoder system" is set. The plausibility check rejects such implausible settings until they have been parameterised correctly. 	
Conditions	The safe directions SDIpos and SDIneg are available from SM301 V1.3.	
Function		
Parameter	C15340	SDI: Standard operation monitoring
	① C15341	SDI: Delay time
	② C15342	SDI: Tolerance threshold
	③ C15343	SDI: Error response
	If the SDI delay time (C15341) is parameterised higher than zero, either the "SDIxxx monitored" response must be evaluated (safety bus or safe output) or the risk analysis must show that the delay does not represent a danger. This must e.g. be considered for the calculation of the safety distance.	
Activation	How to activate the function: <ul style="list-style-type: none"> A data telegram with a corresponding content is sent to the controller via the safety bus. ▶ Safety bus (☞ 61) "OFF state" at a safe input which has been assigned to the function by parameter setting. ▶ Safe inputs (☞ 37) For standard operation, the safe direction can be fixedly set via a safe parameter. The safe direction can be combined with the safely-limited speed SLS. 	
Error behaviour	If the SDI tolerance threshold for the set SDIpos/SDIneg direction is exceeded after the SDI delay time has elapsed an error message is activated and an error stop with the function set in the "SDI: Error response" parameter (STO , SS1 or SS2) is triggered.	

3.10 Safety bus

The safety module provides parameterisable interfaces for standardised safety bus systems. By selecting the bus system, the corresponding parameters are made available.

Short overview of "Safety bus" parameter group:

Parameter	Info	Lenze setting
C15100	S-bus: configuration	No safety bus
C15113	S bus: Filter control data (bit-coded):	
	Bit 0 STO	Passing through
	Bit 1 SS1	Passing through
	Bit 2 SS2	Passing through
	Bit 3 SLS1	Passing through
	Bit 4 SLS2 *	Passing through
	Bit 5 SLS3 *	Passing through
	Bit 6 SLS4 *	Passing through
	Bit 7 SDIpos **	Passing through
	Bit 8 SDIneg **	Passing through
	Bit 9 ES	Passing through
	Bit 11 OMS	Passing through
	Bit 16 PS_AIS	Passing through
	Bit 17 PS_AIE	Passing through
	Bit 23 SSE	Passing through
	Bit 24 SD-Out1	Passing through

* From SM301 V1.1 ** From SM301 V1.3
Unlisted bits are reserved for future extensions!

S-bus: configuration

Selection of the safety bus system used. Communication modes that are currently being supported:

- ▶ Operation without safety bus
- ▶ Operation with PROFIsafe protocol via PROFIBUS
- ▶ Operation with PROFIsafe protocol via PROFINET

S bus: Filter control data

Unused functions in the control data of the safety bus must be set to "Inhibit" via this parameter. Then, these functions cannot be activated anymore via the safety bus independently of the transmitted control data.

3.10.1 PROFIsafe connection

Conditions

The SM301 safety module supports the transmission of safe information via the PROFIsafe protocol according to the specification "PROFIsafe - Profile for Safety Technology", version 2.0, of the PROFIBUS user organisation (PNO). The controller transmits the PROFIsafe information to the safety module for safe evaluation.

PROFIsafe connection	Required communication module	Setting "S bus: Configuration" (C15100)
PROFIBUS	E94AYCPM (PROFIBUS-DP) From software version V1.00	PROFIsafe / PROFIBUS
PROFINET (From SM301 V1.1)	E94AYCER (PROFINET) From software version V0.70	PROFIsafe / PROFINET



Note!

Operation with PROFIsafe via PROFINET is only permissible according to the "PROFIsafe-Profile for Safety Technology" specification, version 2.x!

Addressing

In order that a data telegram reaches the correct device, a unique PROFIsafe target address is required. If "PROFIsafe" has been selected as safety bus, the safety address is accepted simultaneously as the PROFIsafe target address. This address must match the corresponding configuration of the safety PLC.

▶ [Setting of the safety address](#) (📖 33)

PROFIsafe frame



Note!

The PROFIsafe data is sent in the first slot of a PROFIBUS data telegram or in the second slot of a PROFINET data telegram. This must be observed for the hardware configuration of the safety PLC!

The PROFINET data telegram is supported from SM301 V1.1!

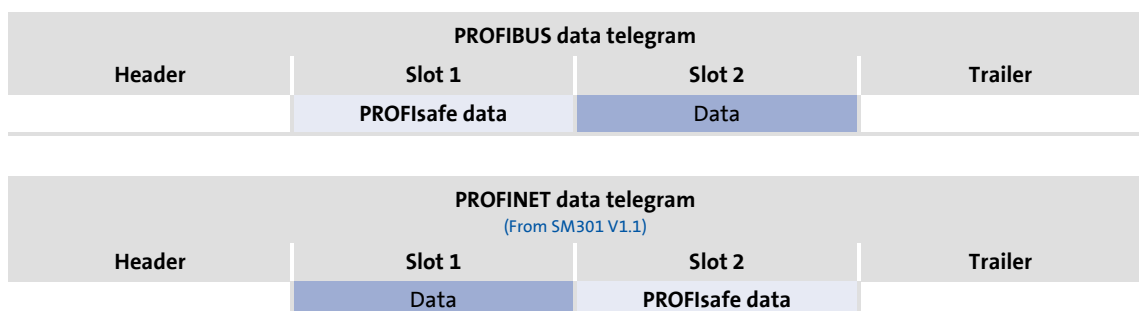

PROFIsafe data

In the PROFIsafe data, one bit each is used to control a certain safety function.

- ▶ The structure of the PROFIsafe message is described in the PROFIsafe profile.
- ▶ The length of the PROFIsafe message in the SM301 is 8 bytes (fix).

PROFIsafe message - V1 mode								
Byte offset	Bit offset							
	7	6	5	4	3	2	1	0
0	PROFIsafe process data (PROFIsafe output data/PROFIsafe input data)							
1								
2								
3								
4	Control byte or status byte							
5	Consecutive number							
6	CRC2 (Signature originating from PROFIsafe process data and PROFIsafe parameters)							
7								

PROFIsafe message - V2 mode <small>(From SM301 V1.1)</small>								
Byte offset	Bit offset							
	7	6	5	4	3	2	1	0
0	PROFIsafe process data (PROFIsafe output data/PROFIsafe input data)							
1								
2								
3								
4	Control byte or status byte							
5	CRC2 (Signature originating from PROFIsafe process data, PROFIsafe parameters and the consecutive number)							
6								
7								

- ▶ In the following subchapters, the meaning of the PROFIsafe process data is separately described for PROFIsafe output data and PROFIsafe input data.



Tip!

Detailed information on the PROFIsafe message can be found in the manual for the safety module and in the PROFIBUS or PROFINET communication manual ([PROFINET is supported from SM301 V1.1](#)).

3.10.1.1 PROFIsafe output data

The PROFIsafe output data (control data) is transmitted from the control to the safety module.

Bit	Name	Value	Meaning
0	STO	0	The STO function is activated.
1	SS1	0	The SS1 function is activated.
2	SS2	0	The SS2 function is activated.
3	SLS1	0	The SLS1 function is activated.
4	SLS2 *	0	The SLS2 function is activated.
5	SLS3 *	0	The SLS3 function is activated.
6	SLS4 *	0	The SLS4 function is activated.
7	SDIpos **	0	The SDIpos function is activated.
8	SDIneg **	0	The SDIneg function is activated.
9	ES	1	Confirmation is active: During special operation → motion functions are possible.
11	OMS	0	Standard operation
		1	Special operation
16	PS_AIS	0/1	Activate restart acknowledgement. The bit must be set for at least one PROFIsafe cycle.
17	PS_AIE	0/1	Activation of error acknowledgement. The bit must be set for at least one PROFIsafe cycle.
23	SSE	0	The SSE function is activated.
24	SD-Out1	0	The SD-Out1 output is set to ON state.

* From SM301 V1.1 ** From SM301 V1.3

Unlisted bits are reserved for future extensions and must be transmitted with "0"!

Unused functions in the control data must be set to "Inhibit" via the parameter "S bus: Filter control data" ([C15113](#)). Then, these functions cannot be activated anymore via the safety bus independently of the transmitted control data.

From SM301 V1.2:

The parameter "S-bus: display control data" ([C15115](#)) displays the control data filtered via [C15113](#).

3.10.1.2 PROFIsafe input data

The PROFIsafe input data (status information) is transmitted from the safety module to the control.

Bit	Name	Value	Meaning
0	STO active	1	The STO function is active and the drive is safely switched to torque-free operation. • This bit is also set by SS1 after the stopping time has elapsed.
1	SS1 active	1	The SS1 function is active. • At the end of the function the bit 0 (STO active) is set.
2	SS2 active	1	The SS2 function is active. • At the end of the function bit 16 (SOS monitored) is set.
3	SLS1 active	1	The SLS1 function is active. • After the Nlim1 braking time has elapsed, bit 17 (SLS1 monitored) is set in addition.
4	SLS2 active *	1	The SLS2 function is active. • After the Nlim2 braking time has elapsed, bit 18 (SLS2 monitored) is set in addition.
5	SLS3 active *	1	The SLS3 function is active. • After the Nlim3 braking time has elapsed, bit 19 (SLS3 monitored) is set in addition.
6	SLS4 active *	1	The SDIpos function is active. • After the Nlim4 braking time has elapsed, bit 20 (SLS4 monitored) is set in addition.
7	SDIpos active **	1	The SDIpos function is active. • After the delay time has elapsed, bit 21 (SDIpos monitored) is set in addition.
8	SDIneg active **	1	The SDIneg function is active. • After the delay time has elapsed, bit 22 (SDIneg monitored) is set in addition.
9	ES active	1	ES function is active during special operation: Motion function
		0	ES function is not active during special operation: Stop function
10	SLI is active ***	1	The SLI function is active.
11	OMS	1	Special operation via safe input or safety bus is requested.
16	SOS active	1	The SOS function is active, i.e. the safe operating stop is monitored.
17	SLS1 monitored	1	The SLS1 function is active, i.e. the compliance with the limited speed 1 is monitored.
18	SLS2 monitored *	1	The SLS2 function is active, i.e. the compliance with the limited speed 2 is monitored.
19	SLS3 monitored *	1	The SLS3 function is active, i.e. the compliance with the limited speed 3 is monitored.
20	SLS4 monitored *	1	The SLS4 function is active, i.e. the compliance with the limited speed 4 is monitored.
21	SDIpos monitored **	1	The SDIpos function is active, i.e. the compliance with the safe direction SDIpos is monitored.
22	SDIneg monitored **	1	The SDIneg function is active, i.e. the compliance with the safe direction SDIneg is monitored.

* From SM301 V1.1 ** From SM301 V1.3 *** From SM301 V1.4
Unlisted bits are reserved for future extensions and must be transmitted with "0"!

SM301 safety module | Parameter setting & configuration

Safe configuration

Safety bus | PROFIsafe connection

Bit	Name	Value	Meaning
23	SSE active	1	The SSE function is active. <ul style="list-style-type: none">• When the emergency stop function STO is parameterised, bit 0 (STO active) is set as well.• When the emergency stop function SS1 is parameterised, first bit 1 (SS1 active) is set and at the end of the function bit 0 (STO active) is set.
24	SD-In1	1	Sensor at I1A and I1B: Channels A and B are in ON state.
25	SD-In2	1	Sensor at I2A and I2B: Channels A and B are in ON state.
26	SD-In3	1	Sensor at I3A and I3B: Channels A and B are in ON state.
27	SD-In4	1	Sensor at I4A and I4B: Channels A and B are in ON state.
29	OMS active *	1	The OMS function is active: Special operation. <ul style="list-style-type: none">• In contrast to bit 11 (OMS), this bit remains set until the special operation is cancelled and the change-over to standard operation has taken place via the stop function.
		0	The OMS function is not active: Standard operation.
31	Error active	1	Error status is active (fault or warning).

* From SM301 V1.1 ** From SM301 V1.3 *** From SM301 V1.4
Unlisted bits are reserved for future extensions and must be transmitted with "0"!

4 Safe parameter transfer

The functions for a safe parameter transfer are available in the *Safe transfer* dialog box.

The *Safe transfer* dialog box is opened via the **Safe transfer** button on the *Safe configuration* tab for the SM301 safety module.

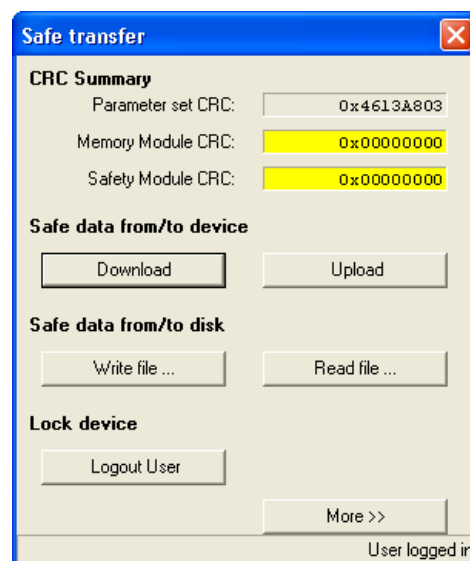

By clicking the **More >>** button in the *Safe transfer* dialog box, the functions for password management and general reset are displayed in addition.

Clicking the button now labelled with **<< Reduce** hides these functions again.

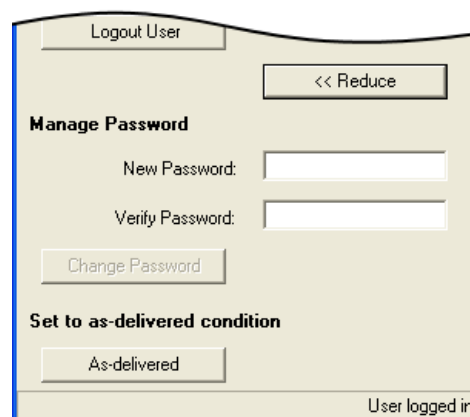

Note!

To execute the functions for a safe parameter transfer, you have to enter a device password!

When the memory module is used for the first time together with the safety module, the required password file for the safe parameter transfer is not yet available in the memory module and the error message "Reading of the password file failed" is displayed. In this case a general reset of the device is required!

With a general reset, the safe parameter set is deleted in the memory module and in the safety module and the required password file is created in the memory module. After this, the safety module must be re-parameterised.

▶ [General reset of the device](#) (73)

4.1 Sending safe data

After the SM301 safety module has been completely parameterised via the *Safe configuration* tab, the parameter set can be safely transmitted to the device using this function.



Note!

This function serves to overwrite the current parameter settings of the safety module with the settings in the »Engineer«!

Before the parameter set is transferred to the safety module, always a plausibility check is carried out. Only a plausible parameter set can be transmitted to the safety module!

[The following applies to SM301 from V1.2:](#)

Before the safe parameter set is transferred, the module ID is checked. If the module ID defined in the parameter set does not correspond to the module ID saved in the safety module, a confirmation prompt appears in order to prevent an unintended change of the module ID through parameter setting.

- If - after having checked the module IDs - you answer the confirmation prompt with **Yes**, the module ID defined in the parameter set is stored in the non-volatile memory of the safety module.
- [C15017](#) displays the module ID stored in the safety module at the last parameter set transfer.
- The module ID stored in the safety module also remains available after a general reset.



How to download the parameter set:

1. Unless there is an online connection, establish an online connection to the device.
2. Go to the *Safe transfer* dialog box and click **Send**.
 - A confirmation prompt appears asking whether the parameter is really to be transmitted to the device.
3. Answer the confirmation prompt with **Yes** to continue the action.

If you are not yet registered as user, first the *Password entry* dialog box is displayed.

4. Enter the device password and confirm with **OK**.
 - Unless an individual password has been defined, enter the standard password which is indicated in the manual for the safety module.
 - After the password has been entered, you are registered as user for a period of 30 minutes. Within this period, the password does not need to be entered again for calling a password-protected function if the online connection to the device remains established without any interruptions.

After the registration, the parameter set is transmitted to the device, and a status message displays whether the action was successful.

5. Confirm the status message with **OK**.



Note!

After the parameter set has been transmitted, make a check of the item designation and a check/acceptance of the safety functions!

Detailed information on the check/acceptance can be found in the manual for the safety module in the "Acceptance" chapter.

4.2 Read safe data from device



Note!

This function serves to overwrite the parameter settings in the »Engineer« with the current settings of the safety module!

Only a valid parameter set can be read back from the safety module.



How to upload the parameter set:

1. Unless there is an online connection, establish an online connection to the device.
2. Go to the *Safe transfer* dialog box and click **Upload**.
 - A confirmation prompt appears asking whether the parameter is really to be uploaded from the device.
3. Answer the confirmation prompt with **Yes** to continue the action.

If you are not yet registered as user, first the *Password entry* dialog box is displayed.

4. Enter the device password and confirm with **OK**.
 - Unless an individual password has been defined, enter the standard password which is indicated in the manual for the safety module.
 - After the password has been entered, you are registered as user for a period of 30 minutes. Within this period, the password does not need to be entered again for calling a password-protected function if the online connection to the device remains established without any interruptions.

After the registration, the parameter set is uploaded from the device, and a status message displays whether the action was successful.

5. Confirm the status message with **OK**.

4.3 Write parameter set into file



How to write the parameter set into a file:

1. Go to the *Safe transfer* dialog box and click **Write file**.
 - The *Safe parameter set* dialog box is displayed.
2. Select the directory from the **Save in** list field, in which the file is to be saved.
3. Enter a file name into the **File name** input field.
4. Click **Save**.
 - The current parameter settings are saved in the selected parameter set file (*.bin) and the *Save parameter set* dialog box is closed.
 - After this, a status message displays whether the action could be carried out successfully.
5. Confirm the status message with **OK**.

4.4 Read parameter set out of file



Note!

This function serves to overwrite the parameter settings in the »Engineer« with the settings of the selected parameter set file (*.bin)!



How to read the parameter set out of the file:

1. Go to the *Safe transfer* dialog box and click **Read file**.
 - A confirmation prompt appears asking whether the data is really to be uploaded and the parameter settings in the »Engineer« are to be overwritten.
2. Answer the confirmation prompt with **Yes** to continue the action.
 - The *Read parameter set* dialog box is displayed.
3. Select the directory which contains the file to be read from the **Search in** list field.
4. Enter the name of the file to be read in the **File name** input field.
5. Click **Open**.
 - The current parameter settings are overwritten with the settings of the selected parameter set file (*.bin) and the *Open parameter set* dialog box is closed.
 - After this, a status message displays whether the action could be carried out successfully.
6. Confirm the status message with **OK**.

4.5 General reset of the device

A general reset is, among other things, required for initialising the memory module if the controller (with the memory module) is used together with an SM301 safety module for the first time.



Note!

This function serves to reset safety data in the memory module.

- The safe parameter set in the memory module and in the safety module is deleted.
- The password file required for the safe parameter transfer is re-created in the memory module. By this the individual device password defined before is reset to the standard password.
- Afterwards the safety module must be re-parameterised.
- The module ID stored in the safety module remains available.



How to execute a general reset of the device:

1. Unless there is an online connection, establish an online connection to the device.
2. Go to the advanced *Safe transfer* dialog box and click **General reset**.
 - The *Standard password entry* dialog box is displayed.
3. Enter the standard password and confirm with **OK**.
 - The standard password can be found in the manual for the safety module.

The general reset is executed and then a status message displays whether the action could be carried out successfully.

4. Confirm the status message with **OK**.

4.6 Password management

For a safe parameter transfer, the device password must be entered.

- ▶ For initial commissioning, use the standard password as the device password, which is given in the manual for the safety module.
- ▶ The **Change Password** function serves to define an individual device password.



Note!

After the password has been entered, you are registered as user for a period of 30 minutes.

- Within this period, the password does not need to be entered again for calling a password-protected function if the online connection to the device remains established without any interruptions.
- The registration status is displayed at the bottom right side of the *Safe transfer* dialog box.
- Click the **Logout User** button to log out before the 30 minutes have elapsed.

Change Password

This function serves to define an individual device password.



How to change the device password:

1. Unless there is an online connection, establish an online connection to the device.
2. Go to the advanced *Safe transfer* dialog box and enter the new password into the **New Password** input field.
 - The password must have at least 6 characters.
3. For verifying the new password re-enter it into the **Verify Password** input field.
 - Only if this input matches the input in the **New Password** input field, the password can be changed.
4. Click the **Change Password** button.

If you are not yet registered as user, first the *Password entry* dialog box is displayed.

5. Enter the device password and confirm with **OK**.
 - Unless an individual password has been defined, enter the standard password which is indicated in the manual for the safety module.

After log-on the password is changed and then a status message displays whether the action could be carried out successfully.

6. Confirm the status message with **OK**.

5 Parameter reference



Note!

This chapter supplements the parameter list and the table of attributes provided in the online documentation for the controller by parameters of the SM301 safety module.



Tip!

General information on parameters can be found in the online documentation for the controller.

5.1 Parameter list

This chapter lists all parameters of the SM301 safety module in numerically ascending order.



Note!

Parameter settings are only possible via the *Safe configuration* tab for the safety module!

▶ [Safe configuration](#) (📖 28)

Only read access is possible to the parameters of the safety module via the »Engineer« parameter list (*All parameters tab* → **Safety module SM301 category**) and the keypad!

C00214

Parameter | Name: **C00214 | Required safety module** Data type: UNSIGNED_8
Index: 24361_d = 5F29_h

Setting of the expected safety module.

- If a safety module is detected which does not match this setting, an error (fault) is triggered. The error can only be eliminated by switching the mains.

Selection list (Lenze setting: Bold)

1	SM0
2	SM100
4	SM300
5	SM301

Read access Write access CINH PLC STOP No transfer COM MOT

SM301 safety module | Parameter setting & configuration

Parameter reference

Parameter list | C15000

C15000

Parameter Name: C15000 Status of safety functions		Data type: BITFIELD_32 Index: 9575 _d = 2567 _h
Bit-coded status word of the safety functions		
Display range		
0x00000000		0xFFFFFFFF
Value is bit-coded:		Info
Bit 0	STO active	▶ Safe torque off
Bit 1	SS1 active	▶ Safe stop 1
Bit 2	SS2 active	▶ Safe stop 2
Bit 3	SLS1 active	▶ Safely limited speed 1
Bit 4	SLS2 active	▶ Safely limited speed 2 (from V1.1)
Bit 5	SLS3 active	▶ Safely limited speed 3 (from V1.1)
Bit 6	SLS4 active	▶ Safely limited speed 4 (from V1.1)
Bit 7	SDIpos active	▶ Safe positive direction (from V1.3)
Bit 8	SDIneg active	▶ Safe negative direction (from V1.3)
Bit 9	ES active	▶ Safe enable switch
Bit 10	SLI active	▶ Safely limited increment (from V1.4)
Bit 11	OMS	▶ Safe operation mode selector
Bit 12	Reserved	
Bit 13	Reserved	
Bit 14	Reserved	
Bit 15	Reserved	
Bit 16	SOS monitored	Safe operating stop is monitored.
Bit 17	SLS1 monitored	Safely limited speed 1 is monitored.
Bit 18	SLS2 monitored	Safely limited speed 2 is monitored (from V1.1)
Bit 19	SLS3 monitored	Safely limited speed 3 is monitored (from V1.1)
Bit 20	SLS4 monitored	Safely limited speed 4 is monitored (from V1.1)
Bit 21	SDIpos monitored	Safe positive direction is monitored (from V1.3)
Bit 22	SDIneg monitored	Safe negative direction is monitored (from V1.3)
Bit 23	SSE active	▶ Emergency stop function
Bit 24	SD-In1 active	▶ Safe inputs
Bit 25	SD-In2 active	▶ Safe inputs
Bit 26	SD-In3 active	▶ Safe inputs
Bit 27	SD-In4 active	▶ Safe inputs
Bit 28	Reserved	
Bit 29	OMS active	▶ Safe operation mode selector (from V1.1)
Bit 30	Reserved	
Bit 31	Error active	
<input checked="" type="checkbox"/> Read access <input type="checkbox"/> Write access <input type="checkbox"/> CINH <input type="checkbox"/> PLC-STOP <input type="checkbox"/> No transfer		

C15003

Parameter Name: C15003 Command status	Data type: UNSIGNED_16 Index: 9572 _d = 2564 _h
Status of the current command.	
<ul style="list-style-type: none"> • The command is repeated in the high byte. • In the low byte the status is displayed: <ul style="list-style-type: none"> 0x00: No command 0x01: Command executed 0x02: Password invalid 0x03: Command in process 0x04: Command not known 0x05: Command error 	
Display range (min. value unit max. value)	
0 2309	
<input checked="" type="checkbox"/> Read access <input type="checkbox"/> Write access <input type="checkbox"/> CINH <input type="checkbox"/> PLC-STOP <input type="checkbox"/> No transfer Scaling factor: 1	

C15010

Parameter Name: C15010 Parameter set status	Data type: UNSIGNED_8 Index: 9565 _d = 255D _h
Status of the parameter set.	
Selection list (only display)	
0	No parameter set
1	Parameter set valid
2	Read error - memory module
3	Unequal parameter set
4	CRC error
5	Version error
6	Format error
7	Plausibility error
8	Assignment error
9	Local read error
10	GG communication error
<input checked="" type="checkbox"/> Read access <input type="checkbox"/> Write access <input type="checkbox"/> CINH <input type="checkbox"/> PLC-STOP <input type="checkbox"/> No transfer Scaling factor: 1	

C15011

Parameter Name: C15011 Parameter CRC	Data type: UNSIGNED_32 Index: 9564 _d = 255C _h
Parameter checksum (CRC = Cyclic Redundancy Code).	
Display range (min. value unit max. value)	
0 4294967295	
Subcodes	Info
C15011/1	CRC safety module
C15011/2	CRC memory module
<input checked="" type="checkbox"/> Read access <input type="checkbox"/> Write access <input type="checkbox"/> CINH <input type="checkbox"/> PLC-STOP <input type="checkbox"/> No transfer Scaling factor: 1	

C15013

Parameter Name: C15013 Parameter set creation time	Data type: UNSIGNED_64 Index: 9562 _d = 255A _h
Time of parameter set creation.	
Display range (min. value unit max. value)	
0 2 ⁶⁴ -1	
<input checked="" type="checkbox"/> Read access <input type="checkbox"/> Write access <input type="checkbox"/> CINH <input type="checkbox"/> PLC-STOP <input type="checkbox"/> No transfer Scaling factor: 1	

SM301 safety module | Parameter setting & configuration

Parameter reference

Parameter list | C15014

C15014

Parameter Name:	Data type: VISIBLE_STRING Index: 9561 _d = 2559 _h
C15014 Time of RTC parameter setting	
Time of acceptance of the parameter set from the memory module as value of the real-time clock (RTC).	
<input checked="" type="checkbox"/> Read access <input type="checkbox"/> Write access <input type="checkbox"/> CINH <input type="checkbox"/> PLC-STOP <input type="checkbox"/> No transfer	

C15015

Parameter Name:	Data type: UNSIGNED_32 Index: 9560 _d = 2558 _h
C15015 Time of sec. parameter setting	
Time of acceptance of the parameter set from the memory module as value of the power-on time meter from the controller.	
Display range (min. value unit max. value)	
0	s 4294967295
<input checked="" type="checkbox"/> Read access <input type="checkbox"/> Write access <input type="checkbox"/> CINH <input type="checkbox"/> PLC-STOP <input type="checkbox"/> No transfer Scaling factor: 1	

C15016

Parameter Name:	Data type: UNSIGNED_8 Index: 9559 _d = 2557 _h
C15016 Parameter set version	
From V1.1	
Display of the parameter set version available in the safety module.	
Selection list (only display)	Info
0 No current parameter set	
1 Parameter set V1.0	
2 Parameter set V1.1	
3 Parameter set V1.2	From V1.2
4 Parameter set V1.3	From V1.3
5 Parameter set V1.4	From V1.4
<input checked="" type="checkbox"/> Read access <input type="checkbox"/> Write access <input type="checkbox"/> CINH <input type="checkbox"/> PLC-STOP <input type="checkbox"/> No transfer Scaling factor: 1	

C15017

Parameter Name:	Data type: UNSIGNED_16 Index: 9558 _d = 2556 _h
C15017 Stored module ID	
From V1.2	
Display range (min. value unit max. value)	
0	65535
<input checked="" type="checkbox"/> Read access <input type="checkbox"/> Write access <input type="checkbox"/> CINH <input type="checkbox"/> PLC-STOP <input type="checkbox"/> No transfer Scaling factor: 1	

C15030

Parameter Name:	Data type: UNSIGNED_8 Index: 9545 _d = 2549 _h
C15030 SD-In sensor type	
Configuration of sensor types which are connected to the safe inputs.	
▶ Safe inputs	
Selection list	
0 Input is deactivated	
1 Passive sensor	
2 Active sensor	
Subcodes	Lenze setting Info
C15030/1	0: Input is deactivated SD-In1 sensor type
C15030/2	0: Input is deactivated SD-In2 sensor type
C15030/3	0: Input is deactivated SD-In3 sensor type
C15030/4	0: Input is deactivated SD-In4 sensor type
<input checked="" type="checkbox"/> Read access <input checked="" type="checkbox"/> Write access <input type="checkbox"/> CINH <input type="checkbox"/> PLC-STOP <input type="checkbox"/> No transfer Scaling factor: 1	

C15031

Parameter Name: C15031 SD-In sensor function		Data type: UNSIGNED_8 Index: 9544 _d = 2548 _h
Function configuration of the safe inputs.		
<ul style="list-style-type: none"> The "operation mode selector" and "enable switch" functions each may only be assigned to one of the four safe inputs. 		
▶ Safe inputs		
Selection list		Info
0	Free assignment	Safety function set in C15032 .
1	Emergency stop	▶ Emergency stop function (SSE)
2	Operation mode selector	▶ Safe operation mode selector (OMS)
3	Enable switch	▶ Safe enable switch (ES)
Subcodes	Lenze setting	Info
C15031/1	0: Free assignment	SD-In1 sensor function
C15031/2	0: Free assignment	SD-In2 sensor function
C15031/3	0: Free assignment	SD-In3 sensor function
C15031/4	0: Free assignment	SD-In4 sensor function
<input checked="" type="checkbox"/> Read access <input checked="" type="checkbox"/> Write access <input type="checkbox"/> CINH <input type="checkbox"/> PLC-STOP <input type="checkbox"/> No transfer		Scaling factor: 1

C15032

Parameter Name: C15032 SD-In free assignment		Data type: UNSIGNED_8 Index: 9543 _d = 2547 _h
Assignment of a safety function to a safe input.		
<ul style="list-style-type: none"> Only possible if the sensor function "Free assignment" is set for the safe input in C15031. 		
▶ Safe inputs		
Selection list		Info
0	STO	▶ Safe torque off
1	SS1	▶ Safe stop 1
2	SS2	▶ Safe stop 2
3	SLS1	▶ Safely limited speed 1
4	SLS2	▶ Safely limited speed 2 (from V1.1)
5	SLS3	▶ Safely limited speed 3 (from V1.1)
6	SLS4	▶ Safely limited speed 4 (from V1.1)
7	SDIpos	▶ Safe positive direction (from V1.3)
8	SDIneg	▶ Safe negative direction (from V1.3)
9	No function	No (local) safety function assigned. <ul style="list-style-type: none"> Function test and monitoring of the discrepancy time are active. The status of the input is transferred to the control via the safety bus (if parameterised).
Subcodes	Lenze setting	Info
C15032/1	0: STO	SD-In1 free assignment
C15032/2	0: STO	SD-In2 free assignment
C15032/3	0: STO	SD-In3 free assignment
C15032/4	0: STO	SD-In4 free assignment
<input checked="" type="checkbox"/> Read access <input checked="" type="checkbox"/> Write access <input type="checkbox"/> CINH <input type="checkbox"/> PLC-STOP <input type="checkbox"/> No transfer		Scaling factor: 1

SM301 safety module | Parameter setting & configuration

Parameter reference

Parameter list | C15033

C15033

Parameter | Name: **C15033 | SD-In discrepancy time** Data type: UNSIGNED_16
Index: 9542_d = 2546_h

Maximum time for which both channels of a safe input may have non-equivalent states without the safety engineering detecting an error.

[▶ Safe inputs](#)

Setting range (min. value unit max. value)		
0	ms	30000
Subcodes	Lenze setting	Info
C15033/1	10 ms	SD-In1 discrepancy time
C15033/2	10 ms	SD-In2 discrepancy time
C15033/3	10 ms	SD-In3 discrepancy time
C15033/4	10 ms	SD-In4 discrepancy time
<input checked="" type="checkbox"/> Read access <input checked="" type="checkbox"/> Write access <input type="checkbox"/> CINH <input type="checkbox"/> PLC-STOP <input type="checkbox"/> No transfer		Scaling factor: 1

C15034

Parameter | Name: **C15034 | SD-In input delay** Data type: UNSIGNED_8
Index: 9541_d = 2545_h

Time between the recognition of the signal change and the effective evaluation of an input signal. As a result, multiple and short signal changes due to contact bounce of the components are not taken into account.

[▶ Safe inputs](#)

Setting range (min. value unit max. value)		
0	ms	100
Subcodes	Lenze setting	Info
C15034/1	0 ms	SD-In1 input delay
C15034/2	0 ms	SD-In2 input delay
C15034/3	0 ms	SD-In3 input delay
C15034/4	0 ms	SD-In4 input delay
<input checked="" type="checkbox"/> Read access <input checked="" type="checkbox"/> Write access <input type="checkbox"/> CINH <input type="checkbox"/> PLC-STOP <input type="checkbox"/> No transfer		Scaling factor: 1

C15035

Parameter | Name: **C15035 | CAS: Cascading** Data type: UNSIGNED_8
Index: 9540_d = 2544_h

From V1.1

Activation of the cascading function.

Use of SD-In4 as cascading input and SD-Out1 as cascading output.

[▶ Safe cascading](#)

Selection list (Lenze setting: Bold)	
0	No cascading
4	Cascading with SD-In4
<input checked="" type="checkbox"/> Read access <input checked="" type="checkbox"/> Write access <input type="checkbox"/> CINH <input type="checkbox"/> PLC-STOP <input type="checkbox"/> No transfer	
Scaling factor: 1	

C15036

Parameter | Name: **C15036 | CAS: Stop delay** Data type: UNSIGNED_16
Index: 9539_d = 2543_h

From V1.1

Delay between setting and receiving the stop signal via cascading.

[▶ Safe cascading](#)

Display range (min. value unit max. value)		
0	ms	65535
<input checked="" type="checkbox"/> Read access <input type="checkbox"/> Write access <input type="checkbox"/> CINH <input type="checkbox"/> PLC-STOP <input type="checkbox"/> No transfer		Scaling factor: 1

C15040

Parameter Name: C15040 Input image		Data type: BITFIELD_32 Index: 9535 _d = 253F _h
Input image of the external module inputs of the safety module, displayed according to channels.		
Display range		
0x00000000		0xFFFFFFFF
Value is bit-coded:		Info
Bit 0	SD-In1 channel A	▶ Safe inputs
Bit 1	SD-In1 channel B	▶ Safe inputs
Bit 2	SD-In2 channel A	▶ Safe inputs
Bit 3	SD-In2 channel B	▶ Safe inputs
Bit 4	SD-In3 channel A	▶ Safe inputs
Bit 5	SD-In3 channel B	▶ Safe inputs
Bit 6	SD-In4 channel A	▶ Safe inputs
Bit 7	SD-In4 channel B	▶ Safe inputs
Bit 8	Reserved	
Bit 9	Reserved	
Bit 10	Reserved	
Bit 11	Reserved	
Bit 12	Reserved	
Bit 13	Reserved	
Bit 14	Reserved	
Bit 15	Reserved	
Bit 16	AIE	AIE input (error acknowledgement)
Bit 17	AIS	AIS input (restart acknowledgement)
Bit 18	Module switch	Module switch in housing front (acceptation of parameter set)
Bit 19	Reserved	
Bit 20	Reserved	
Bit 21	Reserved	
Bit 22	Reserved	
Bit 23	Reserved	
Bit 24	Reserved	
Bit 25	Reserved	
Bit 26	Reserved	
Bit 27	Reserved	
Bit 28	Reserved	
Bit 29	Reserved	
Bit 30	Reserved	
Bit 31	Reserved	
<input checked="" type="checkbox"/> Read access <input type="checkbox"/> Write access <input type="checkbox"/> CINH <input type="checkbox"/> PLC-STOP <input type="checkbox"/> No transfer		

SM301 safety module | Parameter setting & configuration

Parameter reference

Parameter list | C15051

C15051

Parameter Name:		Data type: BITFIELD_32 Index: 9524 _d = 2534 _h
C15051 SD-Out switching condition		
Bit-coded selection of the conditions for switching the safe output.		
▶ Safe output		
Setting range		
0x00000000		0xFFFFFFFF
Value is bit-coded: (<input checked="" type="checkbox"/> = bit set)		Info
Bit 0 <input type="checkbox"/>	STO active	▶ Safe torque off
Bit 1 <input type="checkbox"/>	STO active - neg. logic	▶ Safe torque off
Bit 2 <input type="checkbox"/>	SS1 active	▶ Safe stop 1
Bit 3 <input type="checkbox"/>	SS1 active - neg. logic	▶ Safe stop 1
Bit 4 <input type="checkbox"/>	SS2 active	▶ Safe stop 2
Bit 5 <input type="checkbox"/>	SS2 active - neg. logic	▶ Safe stop 2
Bit 6 <input type="checkbox"/>	SLS1 active	▶ Safely limited speed 1
Bit 7 <input type="checkbox"/>	SLS1 active - neg. logic	▶ Safely limited speed 1
Bit 8 <input type="checkbox"/>	SLS2 active	▶ Safely limited speed 2 (from V1.1)
Bit 9 <input type="checkbox"/>	SLS2 active - neg. logic	▶ Safely limited speed 2 (from V1.1)
Bit 10 <input type="checkbox"/>	SLS3 active	▶ Safely limited speed 3 (from V1.1)
Bit 11 <input type="checkbox"/>	SLS3 active - neg. logic	▶ Safely limited speed 3 (from V1.1)
Bit 12 <input type="checkbox"/>	SLS4 active	▶ Safely limited speed 4 (from V1.1)
Bit 13 <input type="checkbox"/>	SLS4 active - neg. logic	▶ Safely limited speed 4 (from V1.1)
Bit 14 <input type="checkbox"/>	SDIpos active	▶ Safe positive direction (from V1.3)
Bit 15 <input type="checkbox"/>	SDIpos active neg. logic	▶ Safe positive direction (from V1.3)
Bit 16 <input type="checkbox"/>	SDIneg active	▶ Safe negative direction (from V1.3)
Bit 17 <input type="checkbox"/>	SDIneg active neg. logic	▶ Safe negative direction (from V1.3)
Bit 18 <input type="checkbox"/>	ES active	▶ Safe enable switch
Bit 19 <input type="checkbox"/>	ES active - neg. logic	▶ Safe enable switch
Bit 20 <input type="checkbox"/>	SLI active	▶ Safely limited increment (from V1.4)
Bit 21 <input type="checkbox"/>	SLI active - neg. logic	▶ Safely limited increment (from V1.4)
Bit 22 <input type="checkbox"/>	OMS	▶ Safe operation mode selector
Bit 23 <input type="checkbox"/>	OMS neg. logic	▶ Safe operation mode selector
Bit 24 <input type="checkbox"/>	Reserved	
Bit 25 <input type="checkbox"/>	Reserved	
Bit 26 <input type="checkbox"/>	Reserved	
Bit 27 <input type="checkbox"/>	Reserved	
Bit 28 <input type="checkbox"/>	Reserved	
Bit 29 <input type="checkbox"/>	Reserved	
Bit 30 <input type="checkbox"/>	Reserved	
Bit 31 <input type="checkbox"/>	Reserved	
Subcodes	Lenze setting	Info
C15051/1	0x00000000	SD-Out1 switching condition
<input checked="" type="checkbox"/> Read access <input checked="" type="checkbox"/> Write access <input type="checkbox"/> CINH <input type="checkbox"/> PLC-STOP <input type="checkbox"/> No transfer		

C15052

Parameter Name: C15052 SD-Out switching condition	Data type: BITFIELD_32 Index: 9523 _d = 2533 _h
---	--

Bit-coded selection of the conditions for switching the safe output.

▶ [Safe output](#)

Setting range		
0x00000000		0xFFFFFFFF
Value is bit-coded: (<input checked="" type="checkbox"/> = bit set)		Info
Bit 0	<input type="checkbox"/> SOS monitored	Safe operating stop is monitored.
Bit 1	<input type="checkbox"/> SOS monitored - neg. logic	Safe operating stop is not monitored.
Bit 2	<input type="checkbox"/> SLS1 monitored	Safely limited speed 1 is monitored.
Bit 3	<input type="checkbox"/> SLS1 monitored - neg. logic	Safely limited speed 1 is not monitored.
Bit 4	<input type="checkbox"/> SLS2 monitored	Safely limited speed 2 is monitored (from V1.1)
Bit 5	<input type="checkbox"/> SLS2 monitored - neg. logic	Safely limited speed 2 is not monitored.(from V1.1)
Bit 6	<input type="checkbox"/> SLS3 monitored	Safely limited speed 3 is monitored (from V1.1)
Bit 7	<input type="checkbox"/> SLS3 monitored - neg. logic	Safely limited speed 3 is not monitored (from V1.1)
Bit 8	<input type="checkbox"/> SLS4 monitored	Safely limited speed 4 is monitored (from V1.1)
Bit 9	<input type="checkbox"/> SLS4 monitored - neg. logic	Safely limited speed 4 is not monitored (from V1.1)
Bit 10	<input type="checkbox"/> SDIpos monitored	Safe positive direction is monitored (from V1.3)
Bit 11	<input type="checkbox"/> SDIpos observed neg. logic	Safe positive direction is not monitored (from V1.3)
Bit 12	<input type="checkbox"/> SDIneg monitored	Safe negative direction is monitored (from V1.3)
Bit 13	<input type="checkbox"/> SDIneg observed neg. logic	Safe negative direction is not monitored (from V1.3)
Bit 14	<input type="checkbox"/> SSE active	▶ Emergency stop function
Bit 15	<input type="checkbox"/> SSE active - neg. logic	▶ Emergency stop function
Bit 16	<input type="checkbox"/> SD-In1 active	▶ Safe inputs
Bit 17	<input type="checkbox"/> SD-In1 active - neg. logic	▶ Safe inputs
Bit 18	<input type="checkbox"/> SD-In2 active	▶ Safe inputs
Bit 19	<input type="checkbox"/> SD-In2 active - neg. logic	▶ Safe inputs
Bit 20	<input type="checkbox"/> SD-In3 active	▶ Safe inputs
Bit 21	<input type="checkbox"/> SD-In3 active - neg. logic	▶ Safe inputs
Bit 22	<input type="checkbox"/> SD-In4 active	▶ Safe inputs
Bit 23	<input type="checkbox"/> SD-In4 active - neg. logic	▶ Safe inputs
Bit 24	<input type="checkbox"/> Reserved	
Bit 25	<input type="checkbox"/> Reserved	
Bit 26	<input type="checkbox"/> OMS active	▶ Safe operation mode selector (from V1.1)
Bit 27	<input type="checkbox"/> OMS active - neg. logic	▶ Safe operation mode selector (from V1.1)
Bit 28	<input type="checkbox"/> Reserved	
Bit 29	<input type="checkbox"/> Reserved	
Bit 30	<input type="checkbox"/> Error active	
Bit 31	<input type="checkbox"/> Error active - neg. logic	
Subcodes	Lenze setting	Info
C15052/1	0x00000000	SD-Out1 switching condition
<input checked="" type="checkbox"/> Read access <input checked="" type="checkbox"/> Write access <input type="checkbox"/> CINH <input type="checkbox"/> PLC-STOP <input type="checkbox"/> No transfer		

SM301 safety module | Parameter setting & configuration

Parameter reference

Parameter list | C15055

C15055

Parameter Name: C15055 SD-Out logic function		Data type: UNSIGNED_8 Index: 9520 _d = 2530 _h
Selection of the logic operation for the switching conditions to be evaluated.		
▶ Safe output		
Selection list		
0	OR	
1	AND	
Subcodes	Lenze setting	Info
C15055/1	0: OR	SD-Out1 logic function
<input checked="" type="checkbox"/> Read access <input checked="" type="checkbox"/> Write access <input type="checkbox"/> CINH <input type="checkbox"/> PLC-STOP <input type="checkbox"/> No transfer		Scaling factor: 1

C15060

Parameter Name: C15060 Output image		Data type: BITFIELD_16 Index: 9515 _d = 252B _h
Output image of the feedbacks from the safety module, displayed according to channels.		
Display range		
0x0000		0xFFFF
Value is bit-coded:		Info
Bit 0	SD-Out1 channel A	▶ Safe output
Bit 1	SD-Out1 channel B	▶ Safe output
Bit 2	Reserved	
Bit 3	Reserved	
Bit 4	Reserved	
Bit 5	Reserved	
Bit 6	Reserved	
Bit 7	Reserved	
Bit 8	Reserved	
Bit 9	Reserved	
Bit 10	Reserved	
Bit 11	Reserved	
Bit 12	Reserved	
Bit 13	Reserved	
Bit 14	Reserved	
Bit 15	Reserved	
<input checked="" type="checkbox"/> Read access <input type="checkbox"/> Write access <input type="checkbox"/> CINH <input type="checkbox"/> PLC-STOP <input type="checkbox"/> No transfer		

C15100

Parameter Name: C15100 S bus: Configuration		Data type: UNSIGNED_8 Index: 9475 _d = 2503 _h
Configuration of the safe bus system.		
▶ Safety bus		
Selection list (Lenze setting: Bold)		Info
0	No safety bus	
1	PROFIsafe / PROFIBUS	
2	PROFIsafe / PROFINET	From V1.1
<input checked="" type="checkbox"/> Read access <input checked="" type="checkbox"/> Write access <input type="checkbox"/> CINH <input type="checkbox"/> PLC-STOP <input type="checkbox"/> No transfer		Scaling factor: 1

C15101

Parameter Name:	C15101 Current DIP switch display	Data type: UNSIGNED_16 Index: 9474 _d = 2502 _h
Display of the DIP-switch setting (safety address) on the safety module.		
▶ Safety address		
Display range (min. value unit max. value)		
0		1023
<input checked="" type="checkbox"/> Read access <input type="checkbox"/> Write access <input type="checkbox"/> CINH <input type="checkbox"/> PLC-STOP <input type="checkbox"/> No transfer Scaling factor: 1		

C15111

Parameter Name:	C15111 Safety address	Data type: UNSIGNED_16 Index: 9464 _d = 24F8 _h
Safety address in the safety module.		
▶ Safety address		
Setting range (min. value unit max. value)		Lenze setting
0		65534
<input checked="" type="checkbox"/> Read access <input checked="" type="checkbox"/> Write access <input type="checkbox"/> CINH <input type="checkbox"/> PLC-STOP <input type="checkbox"/> No transfer Scaling factor: 1		

C15112

Parameter Name:	C15112 Effective safety address	Data type: UNSIGNED_16 Index: 9463 _d = 24F7 _h
Effectively used safety address in the safety module.		
▶ Safety address		
Display range (min. value unit max. value)		
1		65534
<input checked="" type="checkbox"/> Read access <input type="checkbox"/> Write access <input type="checkbox"/> CINH <input type="checkbox"/> PLC-STOP <input type="checkbox"/> No transfer Scaling factor: 1		

SM301 safety module | Parameter setting & configuration

Parameter reference

Parameter list | C15113

C15113

Setting range		Lenze setting	
0x00000000		0xFFFFFFFF	0x01830BFF (decimal: 25365503)
Value is bit-coded: (<input checked="" type="checkbox"/> = bit set)		Info	
Bit 0 <input checked="" type="checkbox"/>	STO	▶ Safe torque off	
Bit 1 <input checked="" type="checkbox"/>	SS1	▶ Safe stop 1	
Bit 2 <input checked="" type="checkbox"/>	SS2	▶ Safe stop 2	
Bit 3 <input checked="" type="checkbox"/>	SLS1	▶ Safely limited speed 1	
Bit 4 <input checked="" type="checkbox"/>	SLS2	▶ Safely limited speed 2 (from V1.1)	
Bit 5 <input checked="" type="checkbox"/>	SLS3	▶ Safely limited speed 3 (from V1.1)	
Bit 6 <input checked="" type="checkbox"/>	SLS4	▶ Safely limited speed 4 (from V1.1)	
Bit 7 <input checked="" type="checkbox"/>	SDIpos	▶ Safe positive direction (from V1.3)	
Bit 8 <input checked="" type="checkbox"/>	SDIneg	▶ Safe negative direction (from V1.3)	
Bit 9 <input checked="" type="checkbox"/>	ES	▶ Safe enable switch	
Bit 10 <input type="checkbox"/>	Reserved		
Bit 11 <input checked="" type="checkbox"/>	OMS	▶ Safe operation mode selector	
Bit 12 <input type="checkbox"/>	Reserved		
Bit 13 <input type="checkbox"/>	Reserved		
Bit 14 <input type="checkbox"/>	Reserved		
Bit 15 <input type="checkbox"/>	Reserved		
Bit 16 <input checked="" type="checkbox"/>	PS_AIS	Restart acknowledgement via safety bus	
Bit 17 <input checked="" type="checkbox"/>	PS_AIE	Error acknowledgement via safety bus	
Bit 18 <input type="checkbox"/>	Reserved		
Bit 19 <input type="checkbox"/>	Reserved		
Bit 20 <input type="checkbox"/>	Reserved		
Bit 21 <input type="checkbox"/>	Reserved		
Bit 22 <input type="checkbox"/>	Reserved		
Bit 23 <input checked="" type="checkbox"/>	SSE	▶ Emergency stop function	
Bit 24 <input checked="" type="checkbox"/>	SD-Out1	▶ Safe output	
Bit 25 <input type="checkbox"/>	Reserved		
Bit 26 <input type="checkbox"/>	Reserved		
Bit 27 <input type="checkbox"/>	Reserved		
Bit 28 <input type="checkbox"/>	Reserved		
Bit 29 <input type="checkbox"/>	Reserved		
Bit 30 <input type="checkbox"/>	Reserved		
Bit 31 <input type="checkbox"/>	Reserved		

Read access Write access CINH PLC-STOP No transfer

▶ [Safety bus](#)

C15115

Parameter | Name: **C15115 | S bus: Control data display** Data type: BITFIELD_32
Index: 9460_d = 24F4_h

From V1.2

Display of the safety bus control data after being filtered via [C15113](#).

▶ [Safety bus](#)

Display range		
0x00000000		0xFFFFFFFF
Value is bit-coded:		Info
Bit 0	STO	▶ Safe torque off
Bit 1	SS1	▶ Safe stop 1
Bit 2	SS2	▶ Safe stop 2
Bit 3	SLS1	▶ Safely limited speed 1
Bit 4	SLS2	▶ Safely limited speed 2 (from V1.1)
Bit 5	SLS3	▶ Safely limited speed 3 (from V1.1)
Bit 6	SLS4	▶ Safely limited speed 4 (from V1.1)
Bit 7	SDIpos	▶ Safe positive direction (from V1.3)
Bit 8	SDIneg	▶ Safe negative direction (from V1.3)
Bit 9	ES	▶ Safe enable switch
Bit 10	Reserved	
Bit 11	OMS	▶ Safe operation mode selector
Bit 12	Reserved	
Bit 13	Reserved	
Bit 14	Reserved	
Bit 15	Reserved	
Bit 16	PS_AIS	Restart acknowledgement via safety bus
Bit 17	PS_AIE	Error acknowledgement via safety bus
Bit 18	Reserved	
Bit 19	Reserved	
Bit 20	Reserved	
Bit 21	Reserved	
Bit 22	Reserved	
Bit 23	SSE	▶ Emergency stop function
Bit 24	SD-Out1	▶ Safe output
Bit 25	Reserved	
Bit 26	Reserved	
Bit 27	Reserved	
Bit 28	Reserved	
Bit 29	Reserved	
Bit 30	Reserved	
Bit 31	Reserved	

Read access Write access CINH PLC-STOP No transfer

SM301 safety module | Parameter setting & configuration

Parameter reference

Parameter list | C15200

C15200

Parameter | Name: **C15200 | OMS: Stop function** Data type: UNSIGNED_8
Index: 9375_d = 249F_h

Selection of the stop function during special operation.

[▶ Operation mode selection](#)

Selection list (Lenze setting: Bold)		Info
0	STO	▶ Safe torque off
1	SS1	▶ Safe stop 1
2	SS2	▶ Safe stop 2
<input checked="" type="checkbox"/> Read access <input checked="" type="checkbox"/> Write access <input type="checkbox"/> CINH <input type="checkbox"/> PLC-STOP <input type="checkbox"/> No transfer		Scaling factor: 1

C15201

Parameter | Name: **C15201 | OMS: Motion function** Data type: UNSIGNED_8
Index: 9374_d = 249E_h

Selection of the motion function during special operation.

[▶ Operation mode selection](#)

Selection list (Lenze setting: Bold)		Info
3	SLS1	▶ Safely limited speed 1
4	SLS2	▶ Safely limited speed 2 (from V1.1)
5	SLS3	▶ Safely limited speed 3 (from V1.1)
6	SLS4	▶ Safely limited speed 4 (from V1.1)
11	Free traversing	
<input checked="" type="checkbox"/> Read access <input checked="" type="checkbox"/> Write access <input type="checkbox"/> CINH <input type="checkbox"/> PLC-STOP <input type="checkbox"/> No transfer		Scaling factor: 1

C15202

Parameter | Name: **C15202 | OMS: Function at LOW level** Data type: UNSIGNED_8
Index: 9373_d = 249D_h

From V1.3

⚠ Danger!

If the operation mode selector is implemented via a safe input, the operating mode for the LOW level must be selected carefully. According to the closed-circuit principle, there must not arise any additional danger from standard or special operation in the corresponding application.

For detailed information, please see the manual for the safety module.

[▶ Safe operation mode selector](#)

Selection list (Lenze setting: Bold)		Info
0	Standard operation	▶ Operation mode selection
1	Special operation	
<input checked="" type="checkbox"/> Read access <input checked="" type="checkbox"/> Write access <input type="checkbox"/> CINH <input type="checkbox"/> PLC-STOP <input type="checkbox"/> No transfer		Scaling factor: 1

C15203

Parameter | Name: **C15203 | SLI: Safely limited increment** Data type: UNSIGNED_32
Index: 9372_d = 249C_h

From V1.4

Number of increments for safely limited increment.

- Value "0" deactivates the SLI function.

[▶ Operation mode selection](#)

Setting range (min. value unit max. value)			Lenze setting
0	inc	2147483647	1 inc.
<input checked="" type="checkbox"/> Read access <input checked="" type="checkbox"/> Write access <input type="checkbox"/> CINH <input type="checkbox"/> PLC-STOP <input type="checkbox"/> No transfer			Scaling factor: 1

C15204

Parameter | Name: **C15204 | SLI: Value of position change** Data type: UNSIGNED_32
Index: 9371_d = 249B_h

From V1.4

Value of the maximum position change while SLI has been active.

► [Operation mode selection](#)

Display range (min. value unit max. value)		
0	inc	2147483647
<input checked="" type="checkbox"/> Read access <input type="checkbox"/> Write access <input type="checkbox"/> CINH <input type="checkbox"/> PLC-STOP <input type="checkbox"/> No transfer Scaling factor: 1		

C15205

Parameter | Name: **C15205 | SSE: Emergency stop function** Data type: UNSIGNED_8
Index: 9370_d = 249A_h

Selection of the stop function for emergency stop.

► [Emergency stop function \(SSE\)](#)

Selection list (Lenze setting: Bold)	Info
0 STO	► Safe torque off
1 SS1	► Safe stop 1
<input checked="" type="checkbox"/> Read access <input checked="" type="checkbox"/> Write access <input type="checkbox"/> CINH <input type="checkbox"/> PLC-STOP <input type="checkbox"/> No transfer Scaling factor: 1	

C15300

Parameter | Name: **C15300 | Restart behaviour** Data type: UNSIGNED_8
Index: 9275_d = 243B_h

Setting of the restart behaviour after deactivation of the STO, SS1, SS2 and SOS standstill function.

► [Safe stop](#)

Selection list		Info
0	Acknowledged restart	
1	Automatic restart	
Subcodes	Lenze setting	Info
C15300/1	0: Acknowledged restart	Restart - STO, SS1
C15300/2	0: Acknowledged restart	Restart - SS2, SOS
<input checked="" type="checkbox"/> Read access <input checked="" type="checkbox"/> Write access <input type="checkbox"/> CINH <input type="checkbox"/> PLC-STOP <input type="checkbox"/> No transfer Scaling factor: 1		

C15305

Parameter | Name: **C15305 | SS1, SS2: Stopping time** Data type: UNSIGNED_16
Index: 9270_d = 2436_h

Stopping time for the SS1 and SS2 safety functions.

► [Safe stop](#)

Setting range (min. value unit max. value)			Lenze setting
0	ms	30000	0 ms
<input checked="" type="checkbox"/> Read access <input checked="" type="checkbox"/> Write access <input type="checkbox"/> CINH <input type="checkbox"/> PLC-STOP <input type="checkbox"/> No transfer Scaling factor: 1			

C15306

Parameter | Name: **C15306 | SS1 mode** Data type: UNSIGNED_8
Index: 9269_d = 2435_h

From V1.3

Selection whether STO is already activated after reaching n=0 when SS1 is executed or only after the parameterised stopping time.

► [Safe stop 1 \(SS1\)](#)

Selection list (Lenze setting: Bold)	
0 STO after stopping time	
1 STO when n=0	
<input checked="" type="checkbox"/> Read access <input checked="" type="checkbox"/> Write access <input type="checkbox"/> CINH <input type="checkbox"/> PLC-STOP <input type="checkbox"/> No transfer Scaling factor: 1	

SM301 safety module | Parameter setting & configuration

Parameter reference

Parameter list | C15307

C15307

Parameter | Name: **C15307 | SS1: STO delay after n=0** Data type: UNSIGNED_16
Index: 9268_d = 2434_h

From V1.3

Delay time after detection of n=0 until activation of STO.

- Only relevant if "SS1 mode" = "STO with n=0" and operation with encoder system.

► [Safe stop 1 \(SS1\)](#)

Setting range (min. value unit max. value)			Lenze setting
0	ms	30000	0 ms
<input checked="" type="checkbox"/> Read access <input checked="" type="checkbox"/> Write access <input type="checkbox"/> CINH <input type="checkbox"/> PLC-STOP <input type="checkbox"/> No transfer			Scaling factor: 1

C15308

Parameter | Name: **C15308 | SS2 mode** Data type: UNSIGNED_8
Index: 9267_d = 2433_h

From V1.3

Selection whether SOS is already activated after reaching n=0 when SS2 is executed or only after the parameterised stopping time.

► [Safe stop 2 \(SS2\)](#)

Selection list (Lenze setting: Bold)	
0	SOS after stopping time
1	SOS when n=0
<input checked="" type="checkbox"/> Read access <input checked="" type="checkbox"/> Write access <input type="checkbox"/> CINH <input type="checkbox"/> PLC-STOP <input type="checkbox"/> No transfer	
Scaling factor: 1	

C15310

Parameter | Name: **C15310 | Speed window (n=0)** Data type: UNSIGNED_16
Index: 9265_d = 2431_h

Tolerance window for zero speed.

► [Safe stop](#)

Setting range (min. value unit max. value)			Lenze setting
0	rpm	16000	0 rpm
<input checked="" type="checkbox"/> Read access <input checked="" type="checkbox"/> Write access <input type="checkbox"/> CINH <input type="checkbox"/> PLC-STOP <input type="checkbox"/> No transfer			Scaling factor: 1

C15311

Parameter | Name: **C15311 | SOS: Tolerance margin (delta p=0)** Data type: UNSIGNED_32
Index: 9264_d = 2430_h

From V1.3

Safely monitored tolerance margin for zero position change.

► [Safe stop](#)

Setting range (min. value unit max. value)			Lenze setting
0	inc	327680	0 inc.
<input checked="" type="checkbox"/> Read access <input checked="" type="checkbox"/> Write access <input type="checkbox"/> CINH <input type="checkbox"/> PLC-STOP <input type="checkbox"/> No transfer			Scaling factor: 1

C15312

Parameter | Name: **C15312 | SOS: Maximum position change** Data type: UNSIGNED_32
Index: 9263_d = 2429_h

From V1.3

Value of the maximum position change while SOS has been active.

► [Safe stop](#)

Display range (min. value unit max. value)		
0	inc	2147483647
<input checked="" type="checkbox"/> Read access <input type="checkbox"/> Write access <input type="checkbox"/> CINH <input type="checkbox"/> PLC-STOP <input type="checkbox"/> No transfer		
Scaling factor: 1		

C15315

Parameter | Name: **C15315 | SS1, SS2: Ramp monitoring** Data type: UNSIGNED_8
Index: 9260_d = 242C_h

[From V1.4](#)

Selection for whether the deceleration ramp is to be monitored when SS1 and SS2 are executed.

[▶ Safe stop](#)

Selection list (Lenze setting: Bold)	Info
0 No ramp monitoring	
1 Ramp monitoring activated	

Read access Write access CINH PLC-STOP No transfer Scaling factor: 1

C15316

Parameter | Name: **C15316 | SS1, SS2: Ramp - S-ramp time** Data type: UNSIGNED_8
Index: 9259_d = 242B_h

[From V1.4](#)

S-ramp time of the deceleration ramp for SS1 and SS2 if no linear ramp is used.

[▶ Safe stop](#)

Setting range (min. value unit max. value)	Lenze setting
0 % 100	0 %

Read access Write access CINH PLC-STOP No transfer Scaling factor: 1

C15317

Parameter | Name: **C15317 | SS1, SS2: Ramp - start-offset** Data type: UNSIGNED_8
Index: 9258_d = 242A_h

[From V1.4](#)

Speed offset for the start of ramp monitoring.

[▶ Safe stop](#)

Setting range (min. value unit max. value)	Lenze setting
0 % 30	0 %

Read access Write access CINH PLC-STOP No transfer Scaling factor: 1

C15320

Parameter | Name: **C15320 | SMS: Maximum speed Nmax** Data type: UNSIGNED_16
Index: 9254_d = 2427_h

Activation of the SMS function and selection of the maximum speed.

- The setting Nmax = 0 deactivates the function.

[▶ Safe maximum speed \(SMS\)](#)

Setting range (min. value unit max. value)	Lenze setting
0 rpm 16000	1 rpm

Read access Write access CINH PLC-STOP No transfer Scaling factor: 1

C15321

Parameter | Name: **C15321 | SMS: Reaction (n>Nmax)** Data type: UNSIGNED_8
Index: 9254_d = 2426_h

Reaction to exceeding the set maximum speed Nmax.

[▶ Safe maximum speed \(SMS\)](#)

Selection list (Lenze setting: Bold)	Info
0 STO	▶ Safe torque off
1 SS1	▶ Safe stop 1
2 SS2	▶ Safe stop 2

Read access Write access CINH PLC-STOP No transfer Scaling factor: 1

SM301 safety module | Parameter setting & configuration

Parameter reference

Parameter list | C15330

C15330

Parameter Name: C15330 SLS: Limited speed Nlim		Data type: UNSIGNED_16 Index: 9245 _d = 241D _h
Setting of the safely limited speed.		
▶ Safely limited speed (SLS)		
Setting range (min. value unit max. value)		
0	rpm	16000
Subcodes	Lenze setting	Info
C15330/1	0 rpm	SLS1: Limited speed Nlim1
C15330/2	0 rpm	SLS2: Limited speed Nlim2 (from V1.1)
C15330/3	0 rpm	SLS3: Limited speed Nlim3 (from V1.1)
C15330/4	0 rpm	SLS4: Limited speed Nlim4 (from V1.1)
<input checked="" type="checkbox"/> Read access <input checked="" type="checkbox"/> Write access <input type="checkbox"/> CINH <input type="checkbox"/> PLC-STOP <input type="checkbox"/> No transfer		Scaling factor: 1

C15331

Parameter Name: C15331 SLS: Braking time Nlim		Data type: UNSIGNED_16 Index: 9244 _d = 241C _h
Safely monitored time for braking the drive below the limited speed set in C15330 .		
▶ Safely limited speed (SLS)		
Setting range (min. value unit max. value)		
0	ms	30000
Subcodes	Lenze setting	Info
C15331/1	0 ms	SLS1: Braking time Nlim1
C15331/2	0 ms	SLS2: Braking time Nlim2 (from V1.1)
C15331/3	0 ms	SLS3: Braking time Nlim3 (from V1.1)
C15331/4	0 ms	SLS4: Braking time Nlim4 (from V1.1)
<input checked="" type="checkbox"/> Read access <input checked="" type="checkbox"/> Write access <input type="checkbox"/> CINH <input type="checkbox"/> PLC-STOP <input type="checkbox"/> No transfer		Scaling factor: 1

C15332

Parameter Name: C15332 SLS: Reaction (n>Nlim)		Data type: UNSIGNED_8 Index: 9243 _d = 241B _h
Response carried out in the safety module when the limited speed is exceeded.		
▶ Safely limited speed (SLS)		
Selection list		Info
0	STO	▶ Safe torque off
1	SS1	▶ Safe stop 1
2	SS2	▶ Safe stop 2
Subcodes	Lenze setting	Info
C15332/1	1: SS1	SLS1: Response (n>Nlim1)
C15332/2	1: SS1	SLS2: Response (n>Nlim2) (from V1.1)
C15332/3	1: SS1	SLS3: Response (n>Nlim3) (from V1.1)
C15332/4	1: SS1	SLS4: Response (n>Nlim4) (from V1.1)
<input checked="" type="checkbox"/> Read access <input checked="" type="checkbox"/> Write access <input type="checkbox"/> CINH <input type="checkbox"/> PLC-STOP <input type="checkbox"/> No transfer		Scaling factor: 1

C15333

Parameter | Name: **C15333 | SLS: Permissible direction of movement** Data type: UNSIGNED_8
Index: 9242_d = 241A_h

From V1.3

Permissible direction of movement when monitoring SLS.

[▶ Safely limited speed \(SLS\)](#)

Selection list		
0	Both directions enabled	
1	Positive direction enabled	
2	Negative direction enabled	
Subcodes	Lenze setting	Info
C15333/1	0: Both directions enabled	SLS1: Permissible direction of movement
C15333/2	0: Both directions enabled	SLS2: Permissible direction of movement
C15333/3	0: Both directions enabled	SLS3: Permissible direction of movement
C15333/4	0: Both directions enabled	SLS4: Permissible direction of movement
<input checked="" type="checkbox"/> Read access <input checked="" type="checkbox"/> Write access <input type="checkbox"/> CINH <input type="checkbox"/> PLC-STOP <input type="checkbox"/> No transfer Scaling factor: 1		

C15340

Parameter | Name: **C15340 | SDI: Standard operation monitoring** Data type: UNSIGNED_8
Index: 9235_d = 2413_h

From V1.3

Setting of the direction monitoring of the motor during standard operation.

[▶ Safe direction \(SDI\)](#)

Selection list (Lenze setting: Bold)		
0	Both directions enabled	
1	Positive direction enabled	
2	Negative direction enabled	
<input checked="" type="checkbox"/> Read access <input checked="" type="checkbox"/> Write access <input type="checkbox"/> CINH <input type="checkbox"/> PLC-STOP <input type="checkbox"/> No transfer Scaling factor: 1		

C15341

Parameter | Name: **C15341 | SDI: Delay time** Data type: UNSIGNED_16
Index: 9234_d = 2412_h

From V1.3

Safely monitored time from activation up to switching on of the SDIpos/SDIneg monitoring.

[▶ Safe direction \(SDI\)](#)

Setting range (min. value unit max. value)			Lenze setting
0	ms	30000	0 ms
<input checked="" type="checkbox"/> Read access <input checked="" type="checkbox"/> Write access <input type="checkbox"/> CINH <input type="checkbox"/> PLC-STOP <input type="checkbox"/> No transfer Scaling factor: 1			

C15342

Parameter | Name: **C15342 | SDI: Tolerance threshold** Data type: UNSIGNED_32
Index: 9233_d = 2411_h

From V1.3

Setting of the tolerance threshold by how many increments the motor may move in the direction locked by SDI.

[▶ Safe direction \(SDI\)](#)

Setting range (min. value unit max. value)			Lenze setting
0	inc	327680	0 inc.
<input checked="" type="checkbox"/> Read access <input checked="" type="checkbox"/> Write access <input type="checkbox"/> CINH <input type="checkbox"/> PLC-STOP <input type="checkbox"/> No transfer Scaling factor: 1			

SM301 safety module | Parameter setting & configuration

Parameter reference

Parameter list | C15343

C15343

Parameter | Name: **C15343 | SDI: Error response** Data type: UNSIGNED_8
Index: 9232_d = 2410_h

From V1.3

Response to a violation of the permissible direction of movement of the motor.

[▶ Safe direction \(SDI\)](#)

Selection list (Lenze setting: Bold)	Info
0 STO	▶ Safe torque off
1 SS1	▶ Safe stop 1
2 SS2	▶ Safe stop 2
<input checked="" type="checkbox"/> Read access <input checked="" type="checkbox"/> Write access <input type="checkbox"/> CINH <input type="checkbox"/> PLC-STOP <input type="checkbox"/> No transfer Scaling factor: 1	

C15344

Parameter | Name: **C15344 | SDI: Maximum position change** Data type: UNSIGNED_32
Index: 9231_d = 240F_h

From V1.3

Maximum position change in the locked direction when SDI is active.

[▶ Safe direction \(SDI\)](#)

Display range (min. value unit max. value)	Info
0 inc 2147483647	
Subcodes	Info
C15344/1	SDIpos: Maximum position change
C15344/2	SDIneg: Maximum position change
<input checked="" type="checkbox"/> Read access <input type="checkbox"/> Write access <input type="checkbox"/> CINH <input type="checkbox"/> PLC-STOP <input type="checkbox"/> No transfer Scaling factor: 1	

C15350

Parameter | Name: **C15350 | SLS, SMS: Max. response time** Data type: UNSIGNED_16
Index: 9225_d = 2409_h

Maximum time after a speed exceedance has been detected, after which the speed has to fall below the limit.

[▶ Safely limited speed \(SLS\)](#)

Setting range (min. value unit max. value)	Lenze setting
0 ms 30000	0 ms
<input checked="" type="checkbox"/> Read access <input checked="" type="checkbox"/> Write access <input type="checkbox"/> CINH <input type="checkbox"/> PLC-STOP <input type="checkbox"/> No transfer Scaling factor: 1	

C15400

Parameter | Name: **C15400 | Motor encoder system** Data type: UNSIGNED_8
Index: 9175_d = 23D7_h

Selection of the connected encoder system.

[▶ Safe speed measurement and position detection](#)

Selection list (Lenze setting: Bold)	Info
0 No motor encoder	
1 Sin-cos encoder	"Sin-cos encoder" in this connection stands for the entries "Sine/cosine encoder", "absolute value encoder (Hiperface)", and "absolute value encoder (EnDat)" of code C00422 of the 9400 standard device.
2 Resolver	
<input checked="" type="checkbox"/> Read access <input checked="" type="checkbox"/> Write access <input type="checkbox"/> CINH <input type="checkbox"/> PLC-STOP <input type="checkbox"/> No transfer Scaling factor: 1	

C15401

Parameter Name: C15401 Motor encoder status	Data type: UNSIGNED_8 Index: 9174 _d = 23D6 _h
Status of the encoder evaluation.	
▶ Safe speed measurement and position detection	
Selection list (only display)	Info
0 Valid	Encoder data is valid
1 Error	Encoder data are invalid
<input checked="" type="checkbox"/> Read access <input type="checkbox"/> Write access <input type="checkbox"/> CINH <input type="checkbox"/> PLC-STOP <input type="checkbox"/> No transfer Scaling factor: 1	

C15402

Parameter Name: C15402 Actual speed - n_safe	Data type: INTEGER_16 Index: 9173 _d = 23D5 _h
Display of the current speed calculated by the safety module.	
▶ Safe speed measurement and position detection	
Display range (min. value unit max. value)	
-16000 rpm 16000	
<input checked="" type="checkbox"/> Read access <input type="checkbox"/> Write access <input type="checkbox"/> CINH <input type="checkbox"/> PLC-STOP <input type="checkbox"/> No transfer Scaling factor: 1	

C15405

Parameter Name: C15405 Internal actual speed value	Data type: INTEGER_16 Index: 9170 _d = 23D2 _h
From V1.4	
Internal actual speed values of the SM301.	
▶ Safe speed measurement and position detection	
Display range (min. value unit max. value)	
-16000 rpm 16000	
Subcodes	Info
C15405/1	Internal actual speed value nSM determined from the motor position.
C15405/2	Internal actual speed value nGG determined from the position data of the standard device.
<input checked="" type="checkbox"/> Read access <input type="checkbox"/> Write access <input type="checkbox"/> CINH <input type="checkbox"/> PLC-STOP <input type="checkbox"/> No transfer Scaling factor: 1	

C15409

Parameter Name: C15409 Motor mounting direction	Data type: UNSIGNED_8 Index: 9166 _d = 23CE _h
From V1.4	
Setting of the motor mounting direction.	
▶ Safe speed measurement and position detection	
Selection list (Lenze setting: Bold)	
0 Motor rotating in CW direction	
1 Motor rotating in CCW direction	
<input checked="" type="checkbox"/> Read access <input checked="" type="checkbox"/> Write access <input type="checkbox"/> CINH <input type="checkbox"/> PLC-STOP <input type="checkbox"/> No transfer Scaling factor: 1	

SM301 safety module | Parameter setting & configuration

Parameter reference

Parameter list | C15410

C15410

Parameter | Name: **C15410 | Response time of encoder monitoring** Data type: UNSIGNED_8
Index: 9164_d = 23CD_h

From V1.2

Response time of encoder monitoring.

▶ [Safe speed measurement and position detection](#)

Selection list (Lenze setting: Bold)	
0	12ms
10	50ms
20	100 ms

Read access Write access CINH PLC-STOP No transfer Scaling factor: 1

C15411

Parameter | Name: **C15411 | Speed comparison tolerance** Data type: UNSIGNED_16
Index: 9164_d = 23C3_h

From V1.3

Parameterisable tolerance of speed comparison in the safety module.

- See note in chapter "[Safe speed measurement and position detection](#)".

▶ [Safe speed measurement and position detection](#)

Setting range (min. value unit max. value)	Lenze setting
0 rpm 16000	20 rpm

Read access Write access CINH PLC-STOP No transfer Scaling factor: 1

C15420

Parameter | Name: **C15420 | Sin/cos encoder PPR** Data type: UNSIGNED_16
Index: 9155_d = 23C3_h

PPR of the sin/cos encoder used.

▶ [Safe speed measurement and position detection](#)

Setting range (min. value unit max. value)	Lenze setting
1 16384	1

Read access Write access CINH PLC-STOP No transfer Scaling factor: 1

C15430

Parameter | Name: **C15430 | Number of resolver pole pairs** Data type: UNSIGNED_8
Index: 9145_d = 23B9_h

From V1.3

Number of pole pairs of the resolver used as motor encoder system.

▶ [Safe speed measurement and position detection](#)

Setting range (min. value unit max. value)	Lenze setting
1 10	1

Read access Write access CINH PLC-STOP No transfer Scaling factor: 1

C15500

Parameter | Name: **C15500 | Position encoder system** Data type: UNSIGNED_8
Index: 9075_d = 2373_h

From V1.3

Setting of the connected position encoder system.

▶ [Safe speed measurement and position detection](#)

Selection list (Lenze setting: Bold)	
0	No position encoder
1	Analog encoder (sin/cos/TTL)
2	Digital encoder (SSI/bus)

Read access Write access CINH PLC-STOP No transfer Scaling factor: 1

C15501

Parameter Name: C15501 Position encoder gearbox factor	Data type: UNSIGNED_16 Index: 9074 _d = 2372 _h
From V1.3	
Setting of the gearbox factor between motor and position encoder.	
▶ Safe speed measurement and position detection	
Setting range (min. value unit max. value)	Lenze setting
20 % 50000	100 %
<input checked="" type="checkbox"/> Read access <input checked="" type="checkbox"/> Write access <input type="checkbox"/> CINH <input type="checkbox"/> PLC-STOP <input type="checkbox"/> No transfer Scaling factor: 1	

C15502

Parameter Name: C15502 Position encoder mounting direction	Data type: UNSIGNED_8 Index: 9073 _d = 2371 _h
From V1.3	
Setting of the mounting direction of the position encoder referred to the motor encoder.	
▶ Safe speed measurement and position detection	
Selection list (Lenze setting: Bold)	
0 Like motor encoder	
1 Inverse to motor encoder	
<input checked="" type="checkbox"/> Read access <input checked="" type="checkbox"/> Write access <input type="checkbox"/> CINH <input type="checkbox"/> PLC-STOP <input type="checkbox"/> No transfer Scaling factor: 1	

C15800

Parameter Name: C15800 Current error type	Data type: UNSIGNED_8 Index: 8775 _d = 2247 _h
Type of the currently pending error.	
Selection list (only display)	
0 No error	
1 Warning	
2 Fault	
<input checked="" type="checkbox"/> Read access <input type="checkbox"/> Write access <input type="checkbox"/> CINH <input type="checkbox"/> PLC-STOP <input type="checkbox"/> No transfer Scaling factor: 1	

C15801

Parameter Name: C15801 Error history	Data type: UNSIGNED_16 Index: 8774 _d = 2246 _h
List of the last eight errors.	
Display range (min. value unit max. value)	
0 65535	
Subcodes	Info
C15801/1	Error history 1
C15801/2	Error history 2
C15801/3	Error history 3
C15801/4	Error history 4
C15801/5	Error history 5
C15801/6	Error history 6
C15801/7	Error history 7
C15801/8	Error history 8
<input checked="" type="checkbox"/> Read access <input type="checkbox"/> Write access <input type="checkbox"/> CINH <input type="checkbox"/> PLC-STOP <input type="checkbox"/> No transfer Scaling factor: 1	

SM301 safety module | Parameter setting & configuration

Parameter reference

Parameter list | C15805

C15805

Parameter Name: C15805 Service code		Data type: UNSIGNED_32 Index: 8770 _d = 2242 _h
Display of information if parameter set was not successfully checked for plausibility.		
Display range (min. value unit max. value)		
0		4294967295
Subcodes		Info
C15805/1		Service code
C15805/2		Service code
C15805/3		Service code
<input checked="" type="checkbox"/> Read access <input type="checkbox"/> Write access <input type="checkbox"/> CINH <input type="checkbox"/> PLC-STOP <input type="checkbox"/> No transfer		Scaling factor: 1

C15810

Parameter Name: C15810 Service code		Data type: BITFIELD_32 Index: 8765 _d = 223D _h
Display of internal control words.		
Display range		
0x00000000		0xFFFFFFFF
Value is bit-coded:		Info
Bit 0	STO	▶ Safe torque off
Bit 1	SS1	▶ Safe stop 1
Bit 2	SS2	▶ Safe stop 2
Bit 3	SLS1	▶ Safely limited speed 1
Bit 4	SLS2	▶ Safely limited speed 2 (from V1.1)
Bit 5	SLS3	▶ Safely limited speed 3 (from V1.1)
Bit 6	SLS4	▶ Safely limited speed 4 (from V1.1)
Bit 7	SDIpos	▶ Safe positive direction (from V1.3)
Bit 8	SDIneg	▶ Safe negative direction (from V1.3)
Bit 9	ES	▶ Safe enable switch
Bit 10	Reserved	
Bit 11	OMS	▶ Safe operation mode selector
Bit 12	Reserved	
Bit 13	Reserved	
Bit 14	Reserved	
Bit 15	Reserved	
Bit 16	PS_AIS	Restart acknowledgement via safety bus
Bit 17	PS_AIE	Error acknowledgement via safety bus
Bit 18	Reserved	
Bit 19	Reserved	
Bit 20	Reserved	
Bit 21	Reserved	
Bit 22	Reserved	
Bit 23	SSE	▶ Emergency stop function
Bit 24	SD-Out1	▶ Safe output
Bit 25	Reserved	
Bit 26	Reserved	
Bit 27	Reserved	
Bit 28	Reserved	

Parameter Name: C15810 Service code		Data type: BITFIELD_32 Index: 8765 _d = 223D _h
Bit 29	Reserved	
Bit 30	Reserved	
Bit 31	Reserved	
Subcodes	Info	
C15810/1	Service code	
C15810/2	Service code	
C15810/3	Service code	
C15810/4	Service code	
C15810/5	Service code	
C15810/6	Service code	
C15810/7	Service code	
C15810/8	Service code	
C15810/9	Service code	
C15810/10	Service code	
C15810/11	Service code	
<input checked="" type="checkbox"/> Read access <input type="checkbox"/> Write access <input type="checkbox"/> CINH <input type="checkbox"/> PLC-STOP <input type="checkbox"/> No transfer		

C15815

Parameter Name: C15815 Service code		Data type: UNSIGNED_16 Index: 8760 _d = 2238 _h
Status display of the module LEDs.		
Display range (min. value unit max. value)		
0		65535
<input checked="" type="checkbox"/> Read access <input type="checkbox"/> Write access <input type="checkbox"/> CINH <input type="checkbox"/> PLC-STOP <input type="checkbox"/> No transfer Scaling factor: 1		

C15820

Parameter Name: C15820 Internal actual position value		Data type: INTEGER_32 Index: 8755 _d = 2233 _h
Display of internal position values.		
Display range (min. value unit max. value)		
-2147483648	inc	2147483647
Subcodes	Info	
C15820/1	Internal actual position value pSM	
C15820/2	Internal actual position value pGG	
<input checked="" type="checkbox"/> Read access <input type="checkbox"/> Write access <input type="checkbox"/> CINH <input type="checkbox"/> PLC-STOP <input type="checkbox"/> No transfer Scaling factor: 1		

C15821

Parameter Name: C15821 Service code		Data type: INTEGER_16 Index: 8754 _d = 2232 _h
Currently monitored speed value of the ramp monitoring.		
<ul style="list-style-type: none"> • Displayed value only valid if SS1 or SS2 are active with ramp monitoring. 		
Display range (min. value unit max. value)		
-16000	rpm	16000
<input checked="" type="checkbox"/> Read access <input type="checkbox"/> Write access <input type="checkbox"/> CINH <input type="checkbox"/> PLC-STOP <input type="checkbox"/> No transfer Scaling factor: 1		

SM301 safety module | Parameter setting & configuration

Parameter reference

Parameter list | C15822

C15822

Parameter Name: C15822 Service code	Data type: INTEGER_16 Index: 8753 _d = 2231 _h	
Minimum difference between actual speed value and monitored ramp. <ul style="list-style-type: none">The value is maintained until a ramp monitoring is restarted.		
Display range (min. value unit max. value)		
-16000	rpm	16000
<input checked="" type="checkbox"/> Read access <input type="checkbox"/> Write access <input type="checkbox"/> CINH <input type="checkbox"/> PLC-STOP <input type="checkbox"/> No transfer		
Scaling factor: 1		

C15890

Parameter Name: C15890 Current time	Data type: UNSIGNED_32 Index: 8685 _d = 21ED _h	
From V1.4 Relative time for use in the logbook. ▶ Logbook function in the SM301		
Display range (min. value unit max. value)		
0	ms	4294967295
<input checked="" type="checkbox"/> Read access <input type="checkbox"/> Write access <input type="checkbox"/> CINH <input type="checkbox"/> PLC-STOP <input type="checkbox"/> No transfer		
Scaling factor: 1		

C15891

Parameter Name: C15891 Log function	Data type: UNSIGNED_8 Index: 8684 _d = 21EC _h
From V1.4 Setting of the logging response (trigger condition). ▶ Logbook function in the SM301	
Selection list (Lenze setting: Bold)	Info
0 Logging active	Logging always active
1 Logging stopped	Logging switched off.
2 Stop logging in the event of an error	Logging is stopped when an error occurs.
3 Stop logging in the case of STO	Logging is stopped when STO occurs.
4 Stop logging in the case of SS1	Logging is stopped when SS1 occurs.
5 Stop logging in the case of SS2	Logging is stopped when SS2 occurs.
<input checked="" type="checkbox"/> Read access <input checked="" type="checkbox"/> Write access <input type="checkbox"/> CINH <input type="checkbox"/> PLC-STOP <input type="checkbox"/> No transfer	
Scaling factor: 1	

C15892

Parameter | Name: **C15892 | Log time** Data type: UNSIGNED_32
Index: 8683_d = 21EB_h

From V1.4

Time of the log entry.

► [Logbook function in the SM301](#)

Display range (min. value unit max. value)		
0	ms	4294967295
Subcodes	Info	
C15892/1	Log time n	
C15892/2	Log time n-1	
C15892/3	Log time n-2	
C15892/4	Log time n-3	
C15892/5	Log time n-4	
C15892/6	Log time n-5	
C15892/7	Log time n-6	
C15892/8	Log time n-7	
C15892/9	Log time n-8	
C15892/10	Log time n-9	
<input checked="" type="checkbox"/> Read access <input type="checkbox"/> Write access <input type="checkbox"/> CINH <input type="checkbox"/> PLC-STOP <input type="checkbox"/> No transfer Scaling factor: 1		

C15893

Parameter | Name: **C15893 | Log status** Data type: BITFIELD_64
Index: 8682_d = 21EA_h

From V1.4

Logged status.

► [Logbook function in the SM301](#)

Value is bit-coded:	Info
Bit 0 STO via SD-In	STO was triggered via a safe input.
Bit 1 STO via S-bus	STO was triggered via the safety bus.
Bit 2 STO by error	STO was triggered by an error.
Bit 3 Reserved	
Bit 4 SS1 via SD-In	SS1 was triggered via a safe input.
Bit 5 SS1 via S-bus	SS1 was triggered via the safety bus.
Bit 6 SS1 by error	SS1 was triggered by an error.
Bit 7 Reserved	
Bit 8 SS2 via SD-In	SS2 was triggered via a safe input.
Bit 9 SS2 via S-bus	SS2 was triggered via the safety bus.
Bit 10 SS2 by error	SS2 was triggered by an error.
Bit 11 Reserved	
Bit 12 SLS1 via SD-In	SLS1 was triggered via a safe input.
Bit 13 SLS1 via S-bus	SLS1 was triggered via the safety bus.
Bit 14 SLS1 via OMS	SLS1 was triggered via the operating mode changeover.
Bit 15 Reserved	
Bit 16 SLS2 via SD-In	SLS2 was triggered via a safe input.
Bit 17 SLS2 via S-bus	SLS2 was triggered via the safety bus.
Bit 18 SLS2 via OMS	SLS2 was triggered via the operating mode changeover.
Bit 19 Reserved	
Bit 20 SLS3 via SD-In	SLS3 was triggered via a safe input.

SM301 safety module | Parameter setting & configuration

Parameter reference

Parameter list | C15893

Parameter	Name:	Data type: BITFIELD_64 Index: 8682 _d = 21EA _h
C15893	Log status	
Bit 21	SLS3 via S-bus	SLS3 was triggered via the safety bus.
Bit 22	SLS3 via OMS	SLS3 was triggered via the operating mode changeover.
Bit 23	Reserved	
Bit 24	SLS4 via SD-In	SLS4 was triggered via a safe input.
Bit 25	SLS4 via S-bus	SLS4 was triggered via the safety bus.
Bit 26	SLS4 via OMS	SLS4 was triggered via the operating mode changeover.
Bit 27	Reserved	
Bit 28	SDIpos via SD-In	SDIpos was triggered via a safe input.
Bit 29	SDIpos via S-bus	SDIpos was triggered via the safety bus.
Bit 30	SDIpos via SLS	SDIpos was triggered in combination with SLS.
Bit 31	SDIpos in standard operation	SDIpos was triggered during standard operation.
Bit 32	SDIneg via SD-In	SDIneg was triggered via a safe input.
Bit 33	SDIneg via S-bus	SDIneg was triggered via the safety bus.
Bit 34	SDIneg via SLS	SDIneg was triggered in combination with SLS.
Bit 35	SDIneg in standard operation	SDIneg was triggered during standard operation.
Bit 36	SLI active	SLI was triggered during special operation.
Bit 37	Reserved	
Bit 38	Reserved	
Bit 39	Reserved	
Bit 40	Special operation via SD-In	Special operation was triggered via a safe input.
Bit 41	Special operation via S-bus	Special operation was triggered via the safety bus.
Bit 42	Reserved	
Bit 43	Reserved	
Bit 44	ES via SD-In	ES was triggered via a safe input.
Bit 45	ES via S-bus	ES was triggered via the safety bus.
Bit 46	Reserved	
Bit 47	Reserved	
Bit 48	FailSafeValues via control word	Safe substitute values on the safety bus were activated via the control word.
Bit 49	FailSafeValues by error	Safe substitute values on the safety bus were activated by an error.
Bit 50	Reserved	
Bit 51	Reserved	
Bit 52	SD-In1 active	The safe input SD-In1 was switched on.
Bit 53	SD-In2 active	The safe input SD-In2 was switched on.
Bit 54	SD-In3 active	The safe input SD-In3 was switched on.
Bit 55	SD-In4 active	The safe input SD-In4 was switched on.
Bit 56	Reserved	
Bit 57	Reserved	
Bit 58	Reserved	
Bit 59	Reserved	
Bit 60	Reserved	
Bit 61	Reserved	
Bit 62	Reserved	
Bit 63	Reserved	

Parameter Name: C15893 Log status		Data type: BITFIELD_64 Index: 8682 _d = 21EA _h
Subcodes	Info	
C15893/1	Log status n	
C15893/2	Log status n-1	
C15893/3	Log status n-2	
C15893/4	Log status n-3	
C15893/5	Log status n-4	
C15893/6	Log status n-5	
C15893/7	Log status n-6	
C15893/8	Log status n-7	
C15893/9	Log status n-8	
C15893/10	Log status n-9	
<input checked="" type="checkbox"/> Read access <input type="checkbox"/> Write access <input type="checkbox"/> CINH <input type="checkbox"/> PLC-STOP <input type="checkbox"/> No transfer		

C15900

Parameter Name: C15900 Firmware product type		Data type: VISIBLE_STRING Index: 8675 _d = 21E3 _h
Display of the product type (E94AFAE).		
<input checked="" type="checkbox"/> Read access <input type="checkbox"/> Write access <input type="checkbox"/> CINH <input type="checkbox"/> PLC-STOP <input type="checkbox"/> No transfer		

C15901

Parameter Name: C15901 Firmware compilation date		Data type: VISIBLE_STRING Index: 8674 _d = 21E2 _h
Display of the compilation date.		
<input checked="" type="checkbox"/> Read access <input type="checkbox"/> Write access <input type="checkbox"/> CINH <input type="checkbox"/> PLC-STOP <input type="checkbox"/> No transfer		

C15902

Parameter Name: C15902 Firmware version		Data type: VISIBLE_STRING Index: 8673 _d = 21E1 _h
Software version of the firmware, e.g.: "V1.0".		
<input checked="" type="checkbox"/> Read access <input type="checkbox"/> Write access <input type="checkbox"/> CINH <input type="checkbox"/> PLC-STOP <input type="checkbox"/> No transfer		

5.2 Table of attributes

The table of attributes contains information which is required for communicating with the controller via parameters.



Note!

Safety-relevant parameters with write access can only be transmitted to the safety module by safe parameter setting with the »Engineer«.

▶ [Sending safe data](#) (68)

How to read the table of attributes:

Column	Meaning	Entry		
Code	Parameter name	Cxxxxx		
Name	Parameter short text (display text)	<i>Text</i>		
Index	dec	Index by which the parameter is addressed. The subindex of array variables corresponds to the Lenze subcode number.	24575 - Lenze code number	Is only required for access via a bus system.
	hex		5FFFh - Lenze code number	
Data	DS	Data structure	E	Single variable (only one parameter element)
			A	Array variable (several parameter elements)
	DA	Number of array elements (subcodes)	<i>Number</i>	
Data	DT	Data type	BITFIELD_8	1 byte bit-coded
			BITFIELD_16	2 bytes bit-coded
			BITFIELD_32	4 bytes bit-coded
			BITFIELD_64	8 bytes bit-coded
			INTEGER_8	1 byte with sign
			INTEGER_16	2 bytes with sign
			INTEGER_32	4 bytes with sign
			INTEGER_64	8 bytes with sign
			UNSIGNED_8	1 byte without sign
			UNSIGNED_16	2 bytes without sign
			UNSIGNED_32	4 bytes without sign
			UNSIGNED_64	8 bytes without sign
			VISIBLE_STRING	ASCII string
	Factor	Factor for data transmission via a bus system, depending on the number of decimal positions	<i>Factor</i>	1 ≙ no decimal positions 10 ≙ 1 decimal position 100 ≙ 2 decimal positions 1000 ≙ 3 decimal positions
Access	R	Read access	<input checked="" type="checkbox"/> Reading permitted	
	W	Write access	<input checked="" type="checkbox"/> Writing permitted (by safe parameter setting with the »Engineer«)	
	CINH	Controller inhibit required	<input checked="" type="checkbox"/> Writing is only possible when the controller is inhibited	

Table of attributes

Code	Name	Index		Data				Access		
		dec	hex	DS	DA	DT	Factor	R	W	CINH
C15000	Status of safety functions	9575	2567	E	1	BITFIELD_32		<input checked="" type="checkbox"/>		
C15003	Command status	9572	2564	E	1	UNSIGNED_16	1	<input checked="" type="checkbox"/>		
C15010	Parameter set status	9565	255D	E	1	UNSIGNED_8	1	<input checked="" type="checkbox"/>		
C15011	Parameter CRC	9564	255C	A	2	UNSIGNED_32	1	<input checked="" type="checkbox"/>		
C15013	Parameter set creation time	9562	255A	E	1	UNSIGNED_64	1	<input checked="" type="checkbox"/>		
C15014	Time of RTC parameter setting	9561	2559	E	1	VISIBLE_STRING		<input checked="" type="checkbox"/>		
C15015	Time of sec. parameter setting	9560	2558	E	1	UNSIGNED_32	1	<input checked="" type="checkbox"/>		
C15016	Parameter set version	9559	2557	E	1	UNSIGNED_8	1	<input checked="" type="checkbox"/>		
C15017	Stored module ID	9558	2556	E	1	UNSIGNED_16	1	<input checked="" type="checkbox"/>		
C15030	SD-In Sensor type	9545	2549	A	4	UNSIGNED_8	1	<input checked="" type="checkbox"/>	<input checked="" type="checkbox"/>	
C15031	SD-In Sensor function	9544	2548	A	4	UNSIGNED_8	1	<input checked="" type="checkbox"/>	<input checked="" type="checkbox"/>	
C15032	SD-In Free assignment	9543	2547	A	4	UNSIGNED_8	1	<input checked="" type="checkbox"/>	<input checked="" type="checkbox"/>	
C15033	SD-In Discrepancy time	9542	2546	A	4	UNSIGNED_16	1	<input checked="" type="checkbox"/>	<input checked="" type="checkbox"/>	
C15034	SD-In Input delay	9541	2545	A	4	UNSIGNED_8	1	<input checked="" type="checkbox"/>	<input checked="" type="checkbox"/>	
C15035	CAS: Cascading	9540	2544	E	1	UNSIGNED_8	1	<input checked="" type="checkbox"/>	<input checked="" type="checkbox"/>	
C15036	CAS: Stop delay	9539	2543	E	1	UNSIGNED_16	1	<input checked="" type="checkbox"/>		
C15040	Input image	9535	253F	E	1	BITFIELD_32		<input checked="" type="checkbox"/>		
C15051	SD-Out switching condition	9524	2534	A	1	BITFIELD_32		<input checked="" type="checkbox"/>	<input checked="" type="checkbox"/>	
C15052	SD-Out switching condition	9523	2533	A	1	BITFIELD_32		<input checked="" type="checkbox"/>	<input checked="" type="checkbox"/>	
C15055	SD-Out logic function	9520	2530	A	1	UNSIGNED_8	1	<input checked="" type="checkbox"/>	<input checked="" type="checkbox"/>	
C15060	Output image	9515	252B	E	1	BITFIELD_16		<input checked="" type="checkbox"/>		
C15100	S-bus: Configuration	9475	2503	E	1	UNSIGNED_8	1	<input checked="" type="checkbox"/>	<input checked="" type="checkbox"/>	
C15101	Current DIP switch display	9474	2502	E	1	UNSIGNED_16	1	<input checked="" type="checkbox"/>		
C15111	Safety address	9464	24F8	E	1	UNSIGNED_16	1	<input checked="" type="checkbox"/>	<input checked="" type="checkbox"/>	
C15112	Effective safety address	9463	24F7	E	1	UNSIGNED_16	1	<input checked="" type="checkbox"/>		
C15113	S bus: Filter control data	9462	24F6	E	1	BITFIELD_32		<input checked="" type="checkbox"/>	<input checked="" type="checkbox"/>	
C15115	S-bus: Display of control data	9460	24F4	E	1	BITFIELD_32		<input checked="" type="checkbox"/>		
C15200	OMS: Stop function	9375	249F	E	1	UNSIGNED_8	1	<input checked="" type="checkbox"/>	<input checked="" type="checkbox"/>	
C15201	OMS: Motion function	9374	249E	E	1	UNSIGNED_8	1	<input checked="" type="checkbox"/>	<input checked="" type="checkbox"/>	
C15202	OMS: Function at LOW level	9373	249D	E	1	UNSIGNED_8	1	<input checked="" type="checkbox"/>	<input checked="" type="checkbox"/>	
C15203	SLI: Safely limited increment	9372	249C	E	1	UNSIGNED_32	1	<input checked="" type="checkbox"/>	<input checked="" type="checkbox"/>	
C15204	SLI: Value of position change	9371	249B	E	1	UNSIGNED_32	1	<input checked="" type="checkbox"/>		
C15205	SSE: Emergency stop function	9370	249A	E	1	UNSIGNED_8	1	<input checked="" type="checkbox"/>	<input checked="" type="checkbox"/>	
C15300	Restart behaviour	9275	243B	A	2	UNSIGNED_8	1	<input checked="" type="checkbox"/>	<input checked="" type="checkbox"/>	
C15305	SS1, SS2: Stopping time	9270	2436	E	1	UNSIGNED_16	1	<input checked="" type="checkbox"/>	<input checked="" type="checkbox"/>	
C15306	SS1 mode	9269	2435	E	1	UNSIGNED_8	1	<input checked="" type="checkbox"/>	<input checked="" type="checkbox"/>	
C15307	SS1: STO delay after n=0	9268	2434	E	1	UNSIGNED_16	1	<input checked="" type="checkbox"/>	<input checked="" type="checkbox"/>	
C15308	SS2 mode	9267	2433	E	1	UNSIGNED_8	1	<input checked="" type="checkbox"/>	<input checked="" type="checkbox"/>	
C15310	Speed window (n=0)	9265	2431	E	1	UNSIGNED_16	1	<input checked="" type="checkbox"/>	<input checked="" type="checkbox"/>	
C15311	SOS: Tolerance margin (delta p=0) *	9264	2430	E	1	UNSIGNED_32	1	<input checked="" type="checkbox"/>	<input checked="" type="checkbox"/>	
C15312	SOS: Maximum position change	9263	242F	E	1	UNSIGNED_32	1	<input checked="" type="checkbox"/>		
C15315	SS1, SS2: Ramp monitoring	9260	242C	E	1	UNSIGNED_8	1	<input checked="" type="checkbox"/>	<input checked="" type="checkbox"/>	
C15316	SS1, SS2: Ramp - S-ramp time	9259	242B	E	1	UNSIGNED_8	1	<input checked="" type="checkbox"/>	<input checked="" type="checkbox"/>	
C15317	SS1, SS2: Ramp - start-offset	9258	242A	E	1	UNSIGNED_8	1	<input checked="" type="checkbox"/>	<input checked="" type="checkbox"/>	
C15320	SMS: Max. speed Nmax	9255	2427	E	1	UNSIGNED_16	1	<input checked="" type="checkbox"/>	<input checked="" type="checkbox"/>	
C15321	SMS: Reaction (n>Nmax)	9254	2426	E	1	UNSIGNED_8	1	<input checked="" type="checkbox"/>	<input checked="" type="checkbox"/>	
C15330	SLS: Limited speed Nlim	9245	241D	A	4	UNSIGNED_16	1	<input checked="" type="checkbox"/>	<input checked="" type="checkbox"/>	
C15331	SLS: Braking time Nlim	9244	241C	A	4	UNSIGNED_16	1	<input checked="" type="checkbox"/>	<input checked="" type="checkbox"/>	
C15332	SLS: Reaction (n>Nlim)	9243	241B	A	4	UNSIGNED_8	1	<input checked="" type="checkbox"/>	<input checked="" type="checkbox"/>	

SM301 safety module | Parameter setting & configuration

Parameter reference

Table of attributes

Code	Name	Index		Data				Access		
		dec	hex	DS	DA	DT	Factor	R	W	CINH
C15333	SLS: Permissible direction of movement	9242	241A	A	4	UNSIGNED_8	1	<input checked="" type="checkbox"/>	<input checked="" type="checkbox"/>	
C15340	SDI: Standard operation monitoring	9235	2413	E	1	UNSIGNED_8	1	<input checked="" type="checkbox"/>	<input checked="" type="checkbox"/>	
C15341	SDI: Delay time	9234	2412	E	1	UNSIGNED_16	1	<input checked="" type="checkbox"/>	<input checked="" type="checkbox"/>	
C15342	SDI: Tolerance threshold	9233	2411	E	1	UNSIGNED_32	1	<input checked="" type="checkbox"/>	<input checked="" type="checkbox"/>	
C15343	SDI: Error response	9232	2410	E	1	UNSIGNED_8	1	<input checked="" type="checkbox"/>	<input checked="" type="checkbox"/>	
C15344	SDI: Maximum position change	9231	240F	A	2	UNSIGNED_32	1	<input checked="" type="checkbox"/>		
C15350	SLS, SMS: Max. response time	9225	2409	E	1	UNSIGNED_16	1	<input checked="" type="checkbox"/>	<input checked="" type="checkbox"/>	
C15400	Motor encoder system	9175	23D7	E	1	UNSIGNED_8	1	<input checked="" type="checkbox"/>	<input checked="" type="checkbox"/>	
C15401	Motor encoder status	9174	23D6	E	1	UNSIGNED_8	1	<input checked="" type="checkbox"/>		
C15402	Actual speed - n_safe	9173	23D5	E	1	INTEGER_16	1	<input checked="" type="checkbox"/>		
C15405	Internal actual speed value	9170	23D2	A	2	INTEGER_16	1	<input checked="" type="checkbox"/>		
C15409	Motor mounting direction	9166	23CE	E	1	UNSIGNED_8	1	<input checked="" type="checkbox"/>	<input checked="" type="checkbox"/>	
C15410	Response time of encoder monitoring	9165	23CD	E	1	UNSIGNED_8	1	<input checked="" type="checkbox"/>	<input checked="" type="checkbox"/>	
C15411	Speed comparison tolerance	9164	23CC	E	1	UNSIGNED_16	1	<input checked="" type="checkbox"/>	<input checked="" type="checkbox"/>	
C15420	Sin-cos encoder - number of increments	9155	23C3	E	1	UNSIGNED_16	1	<input checked="" type="checkbox"/>	<input checked="" type="checkbox"/>	
C15430	Number of resolver pole pairs	9145	23B9	E	1	UNSIGNED_8	1	<input checked="" type="checkbox"/>	<input checked="" type="checkbox"/>	
C15500	Position encoder system	9075	2373	E	1	UNSIGNED_8	1	<input checked="" type="checkbox"/>	<input checked="" type="checkbox"/>	
C15501	Position encoder gearbox factor	9074	2372	E	1	UNSIGNED_16	1	<input checked="" type="checkbox"/>	<input checked="" type="checkbox"/>	
C15502	Position encoder mounting direction	9073	2371	E	1	UNSIGNED_8	1	<input checked="" type="checkbox"/>	<input checked="" type="checkbox"/>	
C15800	Current error type	8775	2247	E	1	UNSIGNED_8	1	<input checked="" type="checkbox"/>		
C15801	Error history	8774	2246	A	8	UNSIGNED_16	1	<input checked="" type="checkbox"/>		
C15805	Service code	8770	2242	A	3	UNSIGNED_32	1	<input checked="" type="checkbox"/>		
C15810	Service code	8765	223D	A	11	BITFIELD_32		<input checked="" type="checkbox"/>		
C15815	Service code	8760	2238	E	1	UNSIGNED_16	1	<input checked="" type="checkbox"/>		
C15820	Internal actual position value	8755	2233	A	2	INTEGER_32	1	<input checked="" type="checkbox"/>		
C15821	Service code	8754	2232	E	1	INTEGER_16	1	<input checked="" type="checkbox"/>		
C15822	Service code	8753	2231	E	1	INTEGER_16	1	<input checked="" type="checkbox"/>		
C15890	Current time	8685	21ED	E	1	UNSIGNED_32	1	<input checked="" type="checkbox"/>		
C15891	Log function	8684	21EC	E	1	UNSIGNED_8	1	<input checked="" type="checkbox"/>	<input checked="" type="checkbox"/>	
C15892	Log time	8683	21EB	A	10	UNSIGNED_32	1	<input checked="" type="checkbox"/>		
C15893	Log status	8682	21EA	A	10	BITFIELD_64		<input checked="" type="checkbox"/>		
C15900	Firmware product type	8675	21E3	E	1	VISIBLE_STRING		<input checked="" type="checkbox"/>		
C15901	Firmware compilation date	8674	21E2	E	1	VISIBLE_STRING		<input checked="" type="checkbox"/>		
C15902	Firmware version	8673	21E1	E	1	VISIBLE_STRING		<input checked="" type="checkbox"/>		

6 Error messages



Note!

This chapter adds error messages for the SM301 safety module to the error list in the online documentation for the controller.



Tip!

General information on diagnostics & fault analysis and error messages can be found in the online documentation for the controller.

Short overview of error messages for the safety module (A-Z)

hex	dec	Error message	Response (Lenze setting)
0x012f00c3	19857603	Error 2.6V voltage	Warning
0x012f00c2	19857602	5V voltage error	Warning
0x012f00c1	19857601	6V voltage error	Warning
0x012f006d	19857517	CAS: Hardware or discrepancy error	Warning
0x012f006c	19857516	CAS: Circulation time exceeded	Warning
0x012f0039	19857465	Deactivated SD-In1 = high	Warning
0x012f003a	19857466	Deactivated SD-In2 = high	Warning
0x012f003b	19857467	Deactivated SD-In3 = high	Warning
0x012f003c	19857468	Deactivated SD-In4 = high	Warning
0x012f00a5	19857573	Safety parameter set defect	Warning
0x012f0045	19857477	F_CRC_Length error	Information
0x012f0041	19857473	F_Dest_Add = 0 or FFFHex	Information
0x012f0040	19857472	F_Dest_Add unequal F-address	Information
0x012f0044	19857476	F_SIL exceeds technical SIL	Information
0x012f0042	19857474	F_Source_Add = 0 or FFFHex	Information
0x012f0043	19857475	F_WD_Time = 0 msec	Information
0x012f0023	19857443	F_WD_Time exceeded	Information
0x012f0031	19857457	Discrepancy error / functional test - SD-In1	Warning
0x012f0032	19857458	Discrepancy error / functional test - SD-In2	Warning
0x012f0033	19857459	Discrepancy error / functional test - SD-In3	Warning
0x012f0034	19857460	Discrepancy error / functional test - SD-In4	Warning
0x012f0027	19857447	F-parameter error	Information
0x012f005d	19857501	Error - internal disconnecting path	Warning
0x012f0051	19857489	Error - SD-Inx / CLx	Warning
0x012f0052	19857490	Error - SD-Inx / CLx	Warning
0x012f0046	19857478	Incorrect F-parameter version	Information
0x012f0036	19857462	Internal error - AIE	Warning
0x012f0035	19857461	Internal error - AIS	Warning
0x012f0037	19857463	Internal error - module switch	Warning
0x012f0002	19857410	Internal error, SS1 activated	Warning
0x012f0003	19857411	Internal error, SS2 activated	Warning
0x012f0001	19857409	Internal error, STO activated	Warning
0x012f006b	19857515	No encoder system configured	Warning
0x012f00a4	19857572	No safe parameter set for safety module	Warning

SM301 safety module | Parameter setting & configuration

Error messages

hex	dec	Error message	Response (Lenze setting)
0x012f0010	19857424	Communication error - standard device	Warning
0x012f0059	19857497	Short circuit / cross-circuit - SD-Out	Warning
0x012f00a9	19857577	Module ID unequal effective safety address	Warning
0x012f00a0	19857568	New parameter set deleted	Information
0x012f00a1	19857569	New safety parameter set loaded	Information
0x012f00a8	19857576	Parameter set communicaton error	Information
0x012f00a7	19857575	Parameter set plausibility error	Warning
0x012f00a6	19857574	Memory module safety parameter set format error	Warning
0x012f0047	19857479	PROFIsafe CRC1 error	Information
0x012f0025	19857445	PROFIsafe has left data exchange	Information
0x012f0022	19857442	PROFIsafe - communication error	Information
0x012f0024	19857444	PROFIsafe passivated	Information
0x012f0026	19857446	PROFIsafe - invalid data	Information
0x012f00c0	19857600	Reference voltage error	Warning
0x012f0048	19857480	Reserved (PROFIsafe standard)	Information
0x012f0049	19857481	Reserved (PROFIsafe standard)	Information
0x012f004a	19857482	Reserved (PROFIsafe standard)	Information
0x012f0021	19857441	Safety address invalid (0 or FFFhex)	Warning
0x012f0068	19857512	SDIneg: Wrong direction	Warning
0x012f0067	19857511	SDIpos: Wrong direction	Warning
0x012f00d0	19857616	Safe speed invalid	Warning
0x012f006f	19857519	SLI: Safely limited increment exceeded	Warning
0x012f0066	19857510	SLS/SMS: Error stop not executed	Warning
0x012f0062	19857506	SLS1: Nlim1 exceeded	Warning
0x012f0063	19857507	SLS2: Nlim2 exceeded	Warning
0x012f0064	19857508	SLS3: Nlim3 exceeded	Warning
0x012f0065	19857509	SLS4: Nlim4 exceeded	Warning
0x012f0069	19857513	SMS: Nmax exceeded	Warning
0x012f006a	19857514	SOS: Tolerance limit exceeded	Warning
0x012f00a2	19857570	Memory module - parameter set access error	Warning
0x012f006e	19857518	SS1/SS2: Speed ramp exceeded	Warning
0x012f0061	19857505	SS1/SS2: Stopping time exceeded	Warning
0x012f00d6	19857622	SSM: Wrong PDO version	Warning
0x012f00d1	19857617	SSM: Encoder error	Warning
0x012f00d4	19857620	SSM: Speed comparison error	Warning
0x012f00d3	19857619	SSM: Error - standard device data	Warning
0x012f00d2	19857618	SSM: Resolver error	Warning
0x012f00d5	19857621	SSM: Synchronisation error	Warning
0x012f0090	19857552	Stuck at High at SD-In1, channel A	Warning
0x012f0091	19857553	Stuck at High at SD-In1, channel B	Warning
0x012f0092	19857554	Stuck at High at SD-In2, channel A	Warning
0x012f0093	19857555	Stuck at High at SD-In2, channel B	Warning
0x012f0094	19857556	Stuck at High at SD-In3, channel A	Warning
0x012f0095	19857557	Stuck at High at SD-In3, channel B	Warning
0x012f0096	19857558	Stuck at High at SD-In4, channel A	Warning
0x012f0097	19857559	Stuck at High at SD-In4, channel B	Warning
0x012f0080	19857536	Stuck at High SD-Out1, channel A	Warning
0x012f0082	19857538	Stuck at High SD-Out1, channel B	Warning
0x012f0081	19857537	Stuck at Low SD-Out1, channel A	Warning
0x012f0083	19857539	Stuck at Low SD-Out1, channel B	Warning
0x012f0011	19857425	Synchronisation error - standard device	Information

hex	dec	Error message	Response (Lenze setting)
0x012f005e	19857502	Test pulse error - internal disconnecting path	Warning
0x012f00a3	19857571	Different safety parameter sets	Warning

Internal error, STO activated [0x012f0001]

Module ID (decimal)	Error ID (decimal)
303: SM301 safety module	1
Response (Lenze setting printed in bold)	
<input type="checkbox"/> None <input type="checkbox"/> System error <input type="checkbox"/> Error <input type="checkbox"/> Fault <input type="checkbox"/> Quick stop by trouble <input type="checkbox"/> Warning locked <input checked="" type="checkbox"/> Warning <input type="checkbox"/> Information	
Cause	Remedy
Internal error, STO activated.	Replace safety module. Contact Lenze.

Internal error, SS1 activated [0x012f0002]

Module ID (decimal)	Error ID (decimal)
303: SM301 safety module	2
Response (Lenze setting printed in bold)	
<input type="checkbox"/> None <input type="checkbox"/> System error <input type="checkbox"/> Error <input type="checkbox"/> Fault <input type="checkbox"/> Quick stop by trouble <input type="checkbox"/> Warning locked <input checked="" type="checkbox"/> Warning <input type="checkbox"/> Information	
Cause	Remedy
Internal error, SS1 activated	Replace safety module. Contact Lenze.

Internal error, SS2 activated [0x012f0003]

Module ID (decimal)	Error ID (decimal)
303: SM301 safety module	3
Response (Lenze setting printed in bold)	
<input type="checkbox"/> None <input type="checkbox"/> System error <input type="checkbox"/> Error <input type="checkbox"/> Fault <input type="checkbox"/> Quick stop by trouble <input type="checkbox"/> Warning locked <input checked="" type="checkbox"/> Warning <input type="checkbox"/> Information	
Cause	Remedy
Internal error, SS2 activated	Replace safety module. Contact Lenze.

Communication error - standard device [0x012f0010]

Module ID (decimal)	Error ID (decimal)
303: SM301 safety module	16
Response (Lenze setting printed in bold)	
<input type="checkbox"/> None <input type="checkbox"/> System error <input type="checkbox"/> Error <input type="checkbox"/> Fault <input type="checkbox"/> Quick stop by trouble <input type="checkbox"/> Warning locked <input checked="" type="checkbox"/> Warning <input type="checkbox"/> Information	
Cause	Remedy
Communication between the standard device and the safety module has been interrupted. Standard device has been switched off.	Ensure operation in the specified voltage limits.

Synchronisation error - standard device [0x012f0011]

Module ID (decimal)	Error ID (decimal)
303: SM301 safety module	17
Response (Lenze setting printed in bold)	
<input type="checkbox"/> None <input type="checkbox"/> System error <input type="checkbox"/> Error <input type="checkbox"/> Fault <input type="checkbox"/> Quick stop by trouble <input type="checkbox"/> Warning locked <input type="checkbox"/> Warning <input checked="" type="checkbox"/> Information	
Cause	Remedy
Faulty synchronisation with standard device.	Contact Lenze.

Safety address invalid (0 or 0xFFFF) [0x012f0021]

Module ID (decimal)	Error ID (decimal)
303: SM301 safety module	33
Response (Lenze setting printed in bold)	
<input type="checkbox"/> None <input type="checkbox"/> System error <input type="checkbox"/> Error <input type="checkbox"/> Fault <input type="checkbox"/> Quick stop by trouble <input type="checkbox"/> Warning locked <input checked="" type="checkbox"/> Warning <input type="checkbox"/> Information	
Cause	Remedy
Invalid effective safety address. <ul style="list-style-type: none"> • Only for SM300 	<ul style="list-style-type: none"> • Check safety address in the configuration software of the control system. • Check DIP switches on the SM300 safety module. • Check safety address in the safe parameterisation.

PROFIsafe communication error [0x012f0022]

Module ID (decimal)	Error ID (decimal)
303: SM301 safety module	34
Response (Lenze setting printed in bold)	
<input type="checkbox"/> None <input type="checkbox"/> System error <input type="checkbox"/> Error <input type="checkbox"/> Fault <input type="checkbox"/> Quick stop by trouble <input type="checkbox"/> Warning locked <input type="checkbox"/> Warning <input checked="" type="checkbox"/> Information	
Cause	Remedy
PROFIsafe data processing has detected a communication error.	Check cabling between the communication module and the control system.

F_WD_Time exceeded [0x012f0023]

Module ID (decimal)	Error ID (decimal)
303: SM301 safety module	35
Response (Lenze setting printed in bold)	
<input type="checkbox"/> None <input type="checkbox"/> System error <input type="checkbox"/> Error <input type="checkbox"/> Fault <input type="checkbox"/> Quick stop by trouble <input type="checkbox"/> Warning locked <input type="checkbox"/> Warning <input checked="" type="checkbox"/> Information	
Cause	Remedy
PROFIsafe monitoring time exceeded.	<ul style="list-style-type: none"> • Check program runtime of safety program. • Increase monitoring time <i>F_WD_Time</i>.

PROFIsafe passivated [0x012f0024]

Module ID (decimal)	Error ID (decimal)
303: SM301 safety module	36
Response (Lenze setting printed in bold)	
<input type="checkbox"/> None <input type="checkbox"/> System error <input type="checkbox"/> Error <input type="checkbox"/> Fault <input type="checkbox"/> Quick stop by trouble <input type="checkbox"/> Warning locked <input type="checkbox"/> Warning <input checked="" type="checkbox"/> Information	
Cause	Remedy
A fault has occurred in the PROFIsafe data processing. PROFIsafe node is passivated.	<ul style="list-style-type: none"> • Check communication module, bus connection and control program. • Read out fault memory of control system.

PROFIsafe has left data exchange [0x012f0025]

Module ID (decimal)	Error ID (decimal)
303: SM301 safety module	37
Response (Lenze setting printed in bold)	
<input type="checkbox"/> None <input type="checkbox"/> System error <input type="checkbox"/> Error <input type="checkbox"/> Fault <input type="checkbox"/> Quick stop by trouble <input type="checkbox"/> Warning locked <input type="checkbox"/> Warning <input checked="" type="checkbox"/> Information	
Cause	Remedy
A fault has occurred in the PROFIsafe data processing. PROFIsafe has left data exchange.	<ul style="list-style-type: none"> • Check communication module, bus connection and control program. • Read out fault memory of control system.

PROFIsafe - invalid data [0x012f0026]

Module ID (decimal)	Error ID (decimal)
303: SM301 safety module	38
Response (Lenze setting printed in bold)	
<input type="checkbox"/> None <input type="checkbox"/> System error <input type="checkbox"/> Error <input type="checkbox"/> Fault <input type="checkbox"/> Quick stop by trouble <input type="checkbox"/> Warning locked <input type="checkbox"/> Warning <input checked="" type="checkbox"/> Information	
Cause	Remedy
A fault has occurred in the PROFIsafe data processing. PROFIsafe user data area has no valid data.	<ul style="list-style-type: none"> • Check communication module, bus connection and control program. • Read out fault memory of control system.

F-parameter error [0x012f0027]

Module ID (decimal)	Error ID (decimal)
303: SM301 safety module	39
Response (Lenze setting printed in bold)	
<input type="checkbox"/> None <input type="checkbox"/> System error <input type="checkbox"/> Error <input type="checkbox"/> Fault <input type="checkbox"/> Quick stop by trouble <input type="checkbox"/> Warning locked <input type="checkbox"/> Warning <input checked="" type="checkbox"/> Information	
Cause	Remedy
A fault has occurred in the PROFIsafe parameterisation phase. Wrong parameterisation of F-PLC.	<ul style="list-style-type: none"> • Check communication module, bus connection and control program. • Read out fault memory of control system.

SM301 safety module | Parameter setting & configuration

Error messages

Discrepancy error or functional test SD-In1 [0x012f0031]

Module ID (decimal)	Error ID (decimal)
303: SM301 safety module	49
Response (Lenze setting printed in bold)	
<input type="checkbox"/> None <input type="checkbox"/> System error <input type="checkbox"/> Error <input type="checkbox"/> Fault <input type="checkbox"/> Quick stop by trouble <input type="checkbox"/> Warning locked <input checked="" type="checkbox"/> Warning <input type="checkbox"/> Information	
Cause	Remedy
Signal error at two-channel safe input SD-In1.	<ul style="list-style-type: none">• Check safe parameters for SD-In1.• Check sensor at SD-In1.

Discrepancy error or functional test SD-In2 [0x012f0032]

Module ID (decimal)	Error ID (decimal)
303: SM301 safety module	50
Response (Lenze setting printed in bold)	
<input type="checkbox"/> None <input type="checkbox"/> System error <input type="checkbox"/> Error <input type="checkbox"/> Fault <input type="checkbox"/> Quick stop by trouble <input type="checkbox"/> Warning locked <input checked="" type="checkbox"/> Warning <input type="checkbox"/> Information	
Cause	Remedy
Signal error at two-channel safe input SD-In2.	<ul style="list-style-type: none">• Check safe parameters for SD-In2.• Check sensor at SD-In2.

Discrepancy error or functional test SD-In3 [0x012f0033]

Module ID (decimal)	Error ID (decimal)
303: SM301 safety module	51
Response (Lenze setting printed in bold)	
<input type="checkbox"/> None <input type="checkbox"/> System error <input type="checkbox"/> Error <input type="checkbox"/> Fault <input type="checkbox"/> Quick stop by trouble <input type="checkbox"/> Warning locked <input checked="" type="checkbox"/> Warning <input type="checkbox"/> Information	
Cause	Remedy
Signal error at two-channel safe input SD-In3.	<ul style="list-style-type: none">• Check safe parameters for SD-In3.• Check sensor at SD-In3.

Discrepancy error or functional test SD-In4 [0x012f0034]

Module ID (decimal)	Error ID (decimal)
303: SM301 safety module	52
Response (Lenze setting printed in bold)	
<input type="checkbox"/> None <input type="checkbox"/> System error <input type="checkbox"/> Error <input type="checkbox"/> Fault <input type="checkbox"/> Quick stop by trouble <input type="checkbox"/> Warning locked <input checked="" type="checkbox"/> Warning <input type="checkbox"/> Information	
Cause	Remedy
Signal error at two-channel safe input SD-In4.	<ul style="list-style-type: none">• Check safe parameters for SD-In4.• Check sensor at SD-In4.

Internal error - AIS [0x012f0035]

Module ID (decimal)	Error ID (decimal)
303: SM301 safety module	53
Response (Lenze setting printed in bold)	
<input type="checkbox"/> None <input type="checkbox"/> System error <input type="checkbox"/> Error <input type="checkbox"/> Fault <input type="checkbox"/> Quick stop by trouble <input type="checkbox"/> Warning locked <input checked="" type="checkbox"/> Warning <input type="checkbox"/> Information	
Cause	Remedy
Signal error at acknowledgement input AIS.	Replace safety module.

Internal error - AIE [0x012f0036]

Module ID (decimal)	Error ID (decimal)
303: SM301 safety module	54
Response (Lenze setting printed in bold)	
<input type="checkbox"/> None <input type="checkbox"/> System error <input type="checkbox"/> Error <input type="checkbox"/> Fault <input type="checkbox"/> Quick stop by trouble <input type="checkbox"/> Warning locked <input checked="" type="checkbox"/> Warning <input type="checkbox"/> Information	
Cause	Remedy
Signal error at acknowledgement input AIE.	Replace safety module.

Internal error - module switch [0x012f0037]

Module ID (decimal)	Error ID (decimal)
303: SM301 safety module	55
Response (Lenze setting printed in bold)	
<input type="checkbox"/> None <input type="checkbox"/> System error <input type="checkbox"/> Error <input type="checkbox"/> Fault <input type="checkbox"/> Quick stop by trouble <input type="checkbox"/> Warning locked <input checked="" type="checkbox"/> Warning <input type="checkbox"/> Information	
Cause	Remedy
Signal error at module acknowledgement input.	Replace safety module.

Deactivated SD-In1 = high [0x012f0039]

Module ID (decimal)	Error ID (decimal)
303: SM301 safety module	57
Response (Lenze setting printed in bold)	
<input type="checkbox"/> None <input type="checkbox"/> System error <input type="checkbox"/> Error <input type="checkbox"/> Fault <input type="checkbox"/> Quick stop by trouble <input type="checkbox"/> Warning locked <input checked="" type="checkbox"/> Warning <input type="checkbox"/> Information	
Cause	Remedy
Initialisation/parameterisation error: Deactivated input in ON state.	Check connection diagram and parameterisation.

Deactivated SD-In2 = high [0x012f003a]

Module ID (decimal)	Error ID (decimal)
303: SM301 safety module	58
Response (Lenze setting printed in bold)	
<input type="checkbox"/> None <input type="checkbox"/> System error <input type="checkbox"/> Error <input type="checkbox"/> Fault <input type="checkbox"/> Quick stop by trouble <input type="checkbox"/> Warning locked <input checked="" type="checkbox"/> Warning <input type="checkbox"/> Information	
Cause	Remedy
Initialisation/parameterisation error: Deactivated input in ON state.	Check connection diagram and parameterisation.

Deactivated SD-In3 = high [0x012f003b]

Module ID (decimal)	Error ID (decimal)
303: SM301 safety module	59
Response (Lenze setting printed in bold)	
<input type="checkbox"/> None <input type="checkbox"/> System error <input type="checkbox"/> Error <input type="checkbox"/> Fault <input type="checkbox"/> Quick stop by trouble <input type="checkbox"/> Warning locked <input checked="" type="checkbox"/> Warning <input type="checkbox"/> Information	
Cause	Remedy
Initialisation/parameterisation error: Deactivated input in ON state.	Check connection diagram and parameterisation.

SM301 safety module | Parameter setting & configuration

Error messages

Deactivated SD-In4 = high [0x012f003c]

Module ID (decimal)	Error ID (decimal)
303: SM301 safety module	60
Response (Lenze setting printed in bold)	
<input type="checkbox"/> None <input type="checkbox"/> System error <input type="checkbox"/> Error <input type="checkbox"/> Fault <input type="checkbox"/> Quick stop by trouble <input type="checkbox"/> Warning locked <input checked="" type="checkbox"/> Warning <input type="checkbox"/> Information	
Cause	Remedy
Initialisation/parameterisation error: Deactivated input in ON state.	Check connection diagram and parameterisation.

F_Dest_Add unequal F address [0x012f0040]

Module ID (decimal)	Error ID (decimal)
303: SM301 safety module	64
Response (Lenze setting printed in bold)	
<input type="checkbox"/> None <input type="checkbox"/> System error <input type="checkbox"/> Error <input type="checkbox"/> Fault <input type="checkbox"/> Quick stop by trouble <input type="checkbox"/> Warning locked <input type="checkbox"/> Warning <input checked="" type="checkbox"/> Information	
Cause	Remedy
The safety address <i>F_Dest_Add</i> of the control system does not correspond to the F address in the safety module.	Adapt the safety address in the control configuration to the address in the safety module.

F_Dest_Add = 0 or FFFFhex [0x012f0041]

Module ID (decimal)	Error ID (decimal)
303: SM301 safety module	65
Response (Lenze setting printed in bold)	
<input type="checkbox"/> None <input type="checkbox"/> System error <input type="checkbox"/> Error <input type="checkbox"/> Fault <input type="checkbox"/> Quick stop by trouble <input type="checkbox"/> Warning locked <input type="checkbox"/> Warning <input checked="" type="checkbox"/> Information	
Cause	Remedy
The safety address <i>F_Dest_Add</i> in the control system is invalid (0 or FFFF _{hex}).	Select a valid value for the safety address data in the control configuration.

F_Source_Add = 0 or FFFFhex [0x012f0042]

Module ID (decimal)	Error ID (decimal)
303: SM301 safety module	66
Response (Lenze setting printed in bold)	
<input type="checkbox"/> None <input type="checkbox"/> System error <input type="checkbox"/> Error <input type="checkbox"/> Fault <input type="checkbox"/> Quick stop by trouble <input type="checkbox"/> Warning locked <input type="checkbox"/> Warning <input checked="" type="checkbox"/> Information	
Cause	Remedy
The safety address <i>F_Source_Add</i> in the control system is invalid (0 or FFFF _{hex}).	Select a valid value for the safety address data in the control configuration.

F_WD_Time is 0 msec [0x012f0043]

Module ID (decimal)	Error ID (decimal)
303: SM301 safety module	67
Response (Lenze setting printed in bold)	
<input type="checkbox"/> None <input type="checkbox"/> System error <input type="checkbox"/> Error <input type="checkbox"/> Fault <input type="checkbox"/> Quick stop by trouble <input type="checkbox"/> Warning locked <input type="checkbox"/> Warning <input checked="" type="checkbox"/> Information	
Cause	Remedy
The monitoring time <i>F_WD_Time</i> of the control system is set to 0 ms.	Select a permissible value for the monitoring time <i>F_WD_Time</i> .

F_SIL exceeds technical SIL [0x012f0044]

Module ID (decimal)	Error ID (decimal)
303: SM301 safety module	68
Response (Lenze setting printed in bold)	
<input type="checkbox"/> None <input type="checkbox"/> System error <input type="checkbox"/> Error <input type="checkbox"/> Fault <input type="checkbox"/> Quick stop by trouble <input type="checkbox"/> Warning locked <input type="checkbox"/> Warning <input checked="" type="checkbox"/> Information	
Cause	Remedy
The parameterised SIL setting in the control system exceeds the technically possible SIL of the safety module.	Adapt the parameterised SIL setting in the control system to the safety module used.

F_CRC_Length error [0x012f0045]

Module ID (decimal)	Error ID (decimal)
303: SM301 safety module	69
Response (Lenze setting printed in bold)	
<input type="checkbox"/> None <input type="checkbox"/> System error <input type="checkbox"/> Error <input type="checkbox"/> Fault <input type="checkbox"/> Quick stop by trouble <input type="checkbox"/> Warning locked <input type="checkbox"/> Warning <input checked="" type="checkbox"/> Information	
Cause	Remedy
The data length of the <i>F_CRC</i> of the control system is faulty.	Check the safety parameters in the control system.

F parameter version is incorrect [0x012f0046]

Module ID (decimal)	Error ID (decimal)
303: SM301 safety module	70
Response (Lenze setting printed in bold)	
<input type="checkbox"/> None <input type="checkbox"/> System error <input type="checkbox"/> Error <input type="checkbox"/> Fault <input type="checkbox"/> Quick stop by trouble <input type="checkbox"/> Warning locked <input type="checkbox"/> Warning <input checked="" type="checkbox"/> Information	
Cause	Remedy
The F parameter version is incorrect and not supported by the safety module.	Select a permissible F parameter version in the control system.

PROFIsafe CRC1 error [0x012f0047]

Module ID (decimal)	Error ID (decimal)
303: SM301 safety module	71
Response (Lenze setting printed in bold)	
<input type="checkbox"/> None <input type="checkbox"/> System error <input type="checkbox"/> Error <input type="checkbox"/> Fault <input type="checkbox"/> Quick stop by trouble <input type="checkbox"/> Warning locked <input type="checkbox"/> Warning <input checked="" type="checkbox"/> Information	
Cause	Remedy
PROFIsafe-CRC1 error. Current F parameter CRC is faulty.	<ul style="list-style-type: none"> • Check F parameter CRC (CRC1) in the control system. • Check GSD file.

Reserved (PROFIsafe standard) [0x012f0048]

Module ID (decimal)	Error ID (decimal)
303: SM301 safety module	72
Response (Lenze setting printed in bold)	
<input type="checkbox"/> None <input type="checkbox"/> System error <input type="checkbox"/> Error <input type="checkbox"/> Fault <input type="checkbox"/> Quick stop by trouble <input type="checkbox"/> Warning locked <input type="checkbox"/> Warning <input checked="" type="checkbox"/> Information	
Cause	Remedy
--	--

SM301 safety module | Parameter setting & configuration

Error messages

Reserved (PROFIsafe standard) [0x012f0049]

Module ID (decimal)	Error ID (decimal)
303: SM301 safety module	73
Response (Lenze setting printed in bold)	
<input type="checkbox"/> None <input type="checkbox"/> System error <input type="checkbox"/> Error <input type="checkbox"/> Fault <input type="checkbox"/> Quick stop by trouble <input type="checkbox"/> Warning locked <input type="checkbox"/> Warning <input checked="" type="checkbox"/> Information	
Cause	Remedy
--	--

Reserved (PROFIsafe standard) [0x012f004a]

Module ID (decimal)	Error ID (decimal)
303: SM301 safety module	74
Response (Lenze setting printed in bold)	
<input type="checkbox"/> None <input type="checkbox"/> System error <input type="checkbox"/> Error <input type="checkbox"/> Fault <input type="checkbox"/> Quick stop by trouble <input type="checkbox"/> Warning locked <input type="checkbox"/> Warning <input checked="" type="checkbox"/> Information	
Cause	Remedy
--	--

Error - SD-Inx / CLx [0x012f0051]

Module ID (decimal)	Error ID (decimal)
303: SM301 safety module	81
Response (Lenze setting printed in bold)	
<input type="checkbox"/> None <input type="checkbox"/> System error <input type="checkbox"/> Error <input type="checkbox"/> Fault <input type="checkbox"/> Quick stop by trouble <input type="checkbox"/> Warning locked <input checked="" type="checkbox"/> Warning <input type="checkbox"/> Information	
Cause	Remedy
Internal error at a safe input (hardware error).	Replace safety module.

Error - SD-Inx / CLx [0x012f0052]

Module ID (decimal)	Error ID (decimal)
303: SM301 safety module	82
Response (Lenze setting printed in bold)	
<input type="checkbox"/> None <input type="checkbox"/> System error <input type="checkbox"/> Error <input type="checkbox"/> Fault <input type="checkbox"/> Quick stop by trouble <input type="checkbox"/> Warning locked <input checked="" type="checkbox"/> Warning <input type="checkbox"/> Information	
Cause	Remedy
Error at an SD-Inx input or the CLx clock outputs. Only valid for the SM300 safety module!	Check wiring at the SM300 safety module.

Short circuit - SD-Out [0x012f0059]

Module ID (decimal)	Error ID (decimal)
303: SM301 safety module	89
Response (Lenze setting printed in bold)	
<input type="checkbox"/> None <input type="checkbox"/> System error <input type="checkbox"/> Error <input type="checkbox"/> Fault <input type="checkbox"/> Quick stop by trouble <input type="checkbox"/> Warning locked <input checked="" type="checkbox"/> Warning <input type="checkbox"/> Information	
Cause	Remedy
Error at output SD-Out. Only valid for the SM300 safety module!	Check wiring at the SM300 safety module.

Error - internal disconnecting path [0x012f005d]

Module ID (decimal)	Error ID (decimal)
303: SM301 safety module	93
Response (Lenze setting printed in bold)	
<input type="checkbox"/> None <input type="checkbox"/> System error <input type="checkbox"/> Error <input type="checkbox"/> Fault <input type="checkbox"/> Quick stop by trouble <input type="checkbox"/> Warning locked <input checked="" type="checkbox"/> Warning <input type="checkbox"/> Information	
Cause	Remedy
Internal error of safe switch-off logic.	Replace safety module. Contact Lenze.

Test pulse error - internal disconnecting path [0x012f005e]

Module ID (decimal)	Error ID (decimal)
303: SM301 safety module	94
Response (Lenze setting printed in bold)	
<input type="checkbox"/> None <input type="checkbox"/> System error <input type="checkbox"/> Error <input type="checkbox"/> Fault <input type="checkbox"/> Quick stop by trouble <input type="checkbox"/> Warning locked <input checked="" type="checkbox"/> Warning <input type="checkbox"/> Information	
Cause	Remedy
Internal error of safe switch-off logic.	Replace safety module. Contact Lenze.

SS1/SS2: Stopping time exceeded [0x012f0061]

Module ID (decimal)	Error ID (decimal)
303: SM301 safety module	97
Response (Lenze setting printed in bold)	
<input type="checkbox"/> None <input type="checkbox"/> System error <input type="checkbox"/> Error <input type="checkbox"/> Fault <input type="checkbox"/> Quick stop by trouble <input type="checkbox"/> Warning locked <input checked="" type="checkbox"/> Warning <input type="checkbox"/> Information	
Cause	Remedy
The drive has not reached the parameterised zero-speed threshold within the stop time.	<ul style="list-style-type: none"> • Increase SS1/SS2 stop time. • Reduce delay time in drive.

SLS1: Nlim1 exceeded [0x012f0062]

Module ID (decimal)	Error ID (decimal)
303: SM301 safety module	98
Response (Lenze setting printed in bold)	
<input type="checkbox"/> None <input type="checkbox"/> System error <input type="checkbox"/> Error <input type="checkbox"/> Fault <input type="checkbox"/> Quick stop by trouble <input type="checkbox"/> Warning locked <input checked="" type="checkbox"/> Warning <input type="checkbox"/> Information	
Cause	Remedy
The drive has exceeded the limited speed (SLS1).	<ul style="list-style-type: none"> • Adapt the speed-dependent parameters in the drive. • Increase speed threshold Nlim.

SLS2: Nlim2 exceeded [0x012f0063]

Module ID (decimal)	Error ID (decimal)
303: SM301 safety module	99
Response (Lenze setting printed in bold)	
<input type="checkbox"/> None <input type="checkbox"/> System error <input type="checkbox"/> Error <input type="checkbox"/> Fault <input type="checkbox"/> Quick stop by trouble <input type="checkbox"/> Warning locked <input checked="" type="checkbox"/> Warning <input type="checkbox"/> Information	
Cause	Remedy
The drive has exceeded the limited speed (SLS2).	<ul style="list-style-type: none"> • Adapt the speed-dependent parameters in the drive. • Increase speed threshold Nlim.

SM301 safety module | Parameter setting & configuration

Error messages

SLS3: Nlim3 exceeded [0x012f0064]

Module ID (decimal)	Error ID (decimal)
303: SM301 safety module	100
Response (Lenze setting printed in bold)	
<input type="checkbox"/> None <input type="checkbox"/> System error <input type="checkbox"/> Error <input type="checkbox"/> Fault <input type="checkbox"/> Quick stop by trouble <input type="checkbox"/> Warning locked <input checked="" type="checkbox"/> Warning <input type="checkbox"/> Information	
Cause	Remedy
The drive has exceeded the limited speed (SLS3).	<ul style="list-style-type: none">• Adapt the speed-dependent parameters in the drive.• Increase speed threshold Nlim.

SLS4: Nlim4 exceeded [0x012f0065]

Module ID (decimal)	Error ID (decimal)
303: SM301 safety module	101
Response (Lenze setting printed in bold)	
<input type="checkbox"/> None <input type="checkbox"/> System error <input type="checkbox"/> Error <input type="checkbox"/> Fault <input type="checkbox"/> Quick stop by trouble <input type="checkbox"/> Warning locked <input checked="" type="checkbox"/> Warning <input type="checkbox"/> Information	
Cause	Remedy
The drive has exceeded the limited speed (SLS4).	<ul style="list-style-type: none">• Adapt the speed-dependent parameters in the drive.• Increase speed threshold Nlim.

SLS/SMS: Error stop not executed [0x012f0066]

Module ID (decimal)	Error ID (decimal)
303: SM301 safety module	102
Response (Lenze setting printed in bold)	
<input type="checkbox"/> None <input type="checkbox"/> System error <input type="checkbox"/> Error <input type="checkbox"/> Fault <input type="checkbox"/> Quick stop by trouble <input type="checkbox"/> Warning locked <input checked="" type="checkbox"/> Warning <input type="checkbox"/> Information	
Cause	Remedy
The drive has exceeded the limited speed (SLS1-4) or the maximum speed (SMS) and not responded adequately within the maximum response time.	<ul style="list-style-type: none">• Adapt the speed-dependent parameters in the drive.• Increase parameter for the maximum response time.

SDIpos: Wrong direction [0x012f0067]

Module ID (decimal)	Error ID (decimal)
303: SM301 safety module	103
Response (Lenze setting printed in bold)	
<input type="checkbox"/> None <input type="checkbox"/> System error <input type="checkbox"/> Error <input type="checkbox"/> Fault <input type="checkbox"/> Quick stop by trouble <input type="checkbox"/> Warning locked <input checked="" type="checkbox"/> Warning <input type="checkbox"/> Information	
Cause	Remedy
The drive has exceeded the positive monitored direction (SDIpos).	<ul style="list-style-type: none">• Adapt controller parameterisation.• Increase SDI tolerance threshold.

SDIneg: Wrong direction [0x012f0068]

Module ID (decimal)	Error ID (decimal)
303: SM301 safety module	104
Response (Lenze setting printed in bold)	
<input type="checkbox"/> None <input type="checkbox"/> System error <input type="checkbox"/> Error <input type="checkbox"/> Fault <input type="checkbox"/> Quick stop by trouble <input type="checkbox"/> Warning locked <input checked="" type="checkbox"/> Warning <input type="checkbox"/> Information	
Cause	Remedy
The drive has exceeded the negative monitored direction (SDIneg).	<ul style="list-style-type: none">• Adapt controller parameterisation.• Increase SDI tolerance threshold.

SMS: Nmax exceeded [0x012f0069]

Module ID (decimal)	Error ID (decimal)
303: SM301 safety module	105
Response (Lenze setting printed in bold)	
<input type="checkbox"/> None <input type="checkbox"/> System error <input type="checkbox"/> Error <input type="checkbox"/> Fault <input type="checkbox"/> Quick stop by trouble <input type="checkbox"/> Warning locked <input checked="" type="checkbox"/> Warning <input type="checkbox"/> Information	
Cause	Remedy
The drive has exceeded the monitored maximum speed (SMS).	<ul style="list-style-type: none"> • Limit maximum speed in drive. • Adapt parameterisation value.

SOS: Tolerance limit exceeded [0x012f006a]

Module ID (decimal)	Error ID (decimal)
303: SM301 safety module	106
Response (Lenze setting printed in bold)	
<input type="checkbox"/> None <input type="checkbox"/> System error <input type="checkbox"/> Error <input type="checkbox"/> Fault <input type="checkbox"/> Quick stop by trouble <input type="checkbox"/> Warning locked <input checked="" type="checkbox"/> Warning <input type="checkbox"/> Information	
Cause	Remedy
The drive has exceeded a tolerance limit for the SOS function.	<ul style="list-style-type: none"> • Adapt tolerance limits or increase distance to the parameterised limits. • Adapt response time of encoder monitoring.

No encoder system configured [0x012f006b]

Module ID (decimal)	Error ID (decimal)
303: SM301 safety module	107
Response (Lenze setting printed in bold)	
<input type="checkbox"/> None <input type="checkbox"/> System error <input type="checkbox"/> Error <input type="checkbox"/> Fault <input type="checkbox"/> Quick stop by trouble <input type="checkbox"/> Warning locked <input checked="" type="checkbox"/> Warning <input type="checkbox"/> Information	
Cause	Remedy
A speed- or position-based safety function is tried to be carried out without an encoder having been configured.	Configuration of an encoder system valid for safety-related applications.

CAS: Circulation time exceeded [0x012f006c]

Module ID (decimal)	Error ID (decimal)
303: SM301 safety module	108
Response (Lenze setting printed in bold)	
<input type="checkbox"/> None <input type="checkbox"/> System error <input type="checkbox"/> Error <input type="checkbox"/> Fault <input type="checkbox"/> Quick stop by trouble <input type="checkbox"/> Warning locked <input checked="" type="checkbox"/> Warning <input type="checkbox"/> Information	
Cause	Remedy
The maximum time between the activation and feedback of cascading has been exceeded.	<ul style="list-style-type: none"> • Input delay for SD-In4 must be parameterised lower than or equal to 10 ms. • Check wiring between the cascaded modules.

SM301 safety module | Parameter setting & configuration

Error messages

CAS: Hardware or discrepancy error [0x012f006d]

Module ID (decimal)	Error ID (decimal)
303: SM301 safety module	109
Response (Lenze setting printed in bold)	
<input type="checkbox"/> None <input type="checkbox"/> System error <input type="checkbox"/> Error <input type="checkbox"/> Fault <input type="checkbox"/> Quick stop by trouble <input type="checkbox"/> Warning locked <input checked="" type="checkbox"/> Warning <input type="checkbox"/> Information	
Cause	Remedy
The cascading output has not been deactivated by the hardware quickly enough, or there is a discrepancy at the cascading input.	<ul style="list-style-type: none">• Check wiring between the cascaded modules.• Replace safety module.

SS1/SS2: Speed ramp exceeded [0x012f006e]

Module ID (decimal)	Error ID (decimal)
303: SM301 safety module	110
Response (Lenze setting printed in bold)	
<input type="checkbox"/> None <input type="checkbox"/> System error <input type="checkbox"/> Error <input type="checkbox"/> Fault <input type="checkbox"/> Quick stop by trouble <input type="checkbox"/> Warning locked <input checked="" type="checkbox"/> Warning <input type="checkbox"/> Information	
Cause	Remedy
The monitoring of the speed ramp is activated. When the SS1/SS2 stop function is executed, the deceleration of the speed ramp is monitored. If the monitoring limits are exceeded, an error is reported.	<ul style="list-style-type: none">• Adapt ramp monitoring parameters in the safety module.• Adapt (quickstop) ramp parameters in the application.• Deactivate ramp monitoring in the safety module.

SLI: Safely limited increment exceeded [0x012f006f]

Module ID (decimal)	Error ID (decimal)
303: SM301 safety module	111
Response (Lenze setting printed in bold)	
<input type="checkbox"/> None <input type="checkbox"/> System error <input type="checkbox"/> Error <input type="checkbox"/> Fault <input type="checkbox"/> Quick stop by trouble <input type="checkbox"/> Warning locked <input checked="" type="checkbox"/> Warning <input type="checkbox"/> Information	
Cause	Remedy
The safely limited increment is monitored in the "special operation" operating mode. The increment parameterised was exceeded.	<ul style="list-style-type: none">• Adapt "SLI: Safely limited increment" parameter.• Limit increments in the application.• Deactivate monitoring of the safely limited increment.

Stuck at High SD-Out1, channel A [0x012f0080]

Module ID (decimal)	Error ID (decimal)
303: SM301 safety module	128
Response (Lenze setting printed in bold)	
<input type="checkbox"/> None <input type="checkbox"/> System error <input type="checkbox"/> Error <input type="checkbox"/> Fault <input type="checkbox"/> Quick stop by trouble <input type="checkbox"/> Warning locked <input checked="" type="checkbox"/> Warning <input type="checkbox"/> Information	
Cause	Remedy
Channel A of output SD-Out1 cannot be deactivated.	Check wiring at the output SD-Out1 for short circuit.

Stuck at Low SD-Out1, channel A [0x012f0081]

Module ID (decimal)	Error ID (decimal)
303: SM301 safety module	129
Response (Lenze setting printed in bold)	
<input type="checkbox"/> None <input type="checkbox"/> System error <input type="checkbox"/> Error <input type="checkbox"/> Fault <input type="checkbox"/> Quick stop by trouble <input type="checkbox"/> Warning locked <input checked="" type="checkbox"/> Warning <input type="checkbox"/> Information	
Cause	Remedy
Channel A of output SD-Out1 cannot be activated.	Check supply voltage and wiring for the safe output.

Stuck at High SD-Out1, channel B [0x012f0082]

Module ID (decimal)	Error ID (decimal)
303: SM301 safety module	130
Response (Lenze setting printed in bold)	
<input type="checkbox"/> None <input type="checkbox"/> System error <input type="checkbox"/> Error <input type="checkbox"/> Fault <input type="checkbox"/> Quick stop by trouble <input type="checkbox"/> Warning locked <input checked="" type="checkbox"/> Warning <input type="checkbox"/> Information	
Cause	Remedy
Channel B of output SD-Out1 cannot be deactivated.	Check wiring at the output SD-Out1 for short circuit.

Stuck at Low SD-Out1, channel B [0x012f0083]

Module ID (decimal)	Error ID (decimal)
303: SM301 safety module	131
Response (Lenze setting printed in bold)	
<input type="checkbox"/> None <input type="checkbox"/> System error <input type="checkbox"/> Error <input type="checkbox"/> Fault <input type="checkbox"/> Quick stop by trouble <input type="checkbox"/> Warning locked <input checked="" type="checkbox"/> Warning <input type="checkbox"/> Information	
Cause	Remedy
Channel B of output SD-Out1 cannot be activated.	Check supply voltage and wiring for the safe output.

Stuck at High at SD-In1, channel A [0x012f0090]

Module ID (decimal)	Error ID (decimal)
303: SM301 safety module	144
Response (Lenze setting printed in bold)	
<input type="checkbox"/> None <input type="checkbox"/> System error <input type="checkbox"/> Error <input type="checkbox"/> Fault <input type="checkbox"/> Quick stop by trouble <input type="checkbox"/> Warning locked <input checked="" type="checkbox"/> Warning <input type="checkbox"/> Information	
Cause	Remedy
Channel A of input SD-In1 cannot be deactivated.	<ul style="list-style-type: none"> • Check wiring at the safe input for short circuit. • Check configuration for the safe input.

Stuck at High at SD-In1, channel B [0x012f0091]

Module ID (decimal)	Error ID (decimal)
303: SM301 safety module	145
Response (Lenze setting printed in bold)	
<input type="checkbox"/> None <input type="checkbox"/> System error <input type="checkbox"/> Error <input type="checkbox"/> Fault <input type="checkbox"/> Quick stop by trouble <input type="checkbox"/> Warning locked <input checked="" type="checkbox"/> Warning <input type="checkbox"/> Information	
Cause	Remedy
Channel B of input SD-In1 cannot be deactivated.	<ul style="list-style-type: none"> • Check wiring at the safe input for short circuit. • Check configuration for the safe input.

SM301 safety module | Parameter setting & configuration

Error messages

Stuck at High at SD-In2, channel A [0x012f0092]

Module ID (decimal)	Error ID (decimal)
303: SM301 safety module	146
Response (Lenze setting printed in bold)	
<input type="checkbox"/> None <input type="checkbox"/> System error <input type="checkbox"/> Error <input type="checkbox"/> Fault <input type="checkbox"/> Quick stop by trouble <input type="checkbox"/> Warning locked <input checked="" type="checkbox"/> Warning <input type="checkbox"/> Information	
Cause	Remedy
Channel A of input SD-In2 cannot be deactivated.	<ul style="list-style-type: none">• Check wiring at the safe input for short circuit.• Check configuration for the safe input.

Stuck at High at SD-In2, channel B [0x012f0093]

Module ID (decimal)	Error ID (decimal)
303: SM301 safety module	147
Response (Lenze setting printed in bold)	
<input type="checkbox"/> None <input type="checkbox"/> System error <input type="checkbox"/> Error <input type="checkbox"/> Fault <input type="checkbox"/> Quick stop by trouble <input type="checkbox"/> Warning locked <input checked="" type="checkbox"/> Warning <input type="checkbox"/> Information	
Cause	Remedy
Channel B of input SD-In2 cannot be deactivated.	<ul style="list-style-type: none">• Check wiring at the safe input for short circuit.• Check configuration for the safe input.

Stuck at High at SD-In3, channel A [0x012f0094]

Module ID (decimal)	Error ID (decimal)
303: SM301 safety module	148
Response (Lenze setting printed in bold)	
<input type="checkbox"/> None <input type="checkbox"/> System error <input type="checkbox"/> Error <input type="checkbox"/> Fault <input type="checkbox"/> Quick stop by trouble <input type="checkbox"/> Warning locked <input checked="" type="checkbox"/> Warning <input type="checkbox"/> Information	
Cause	Remedy
Channel A of input SD-In3 cannot be deactivated.	<ul style="list-style-type: none">• Check wiring at the safe input for short circuit.• Check configuration for the safe input.

Stuck at High at SD-In3, channel B [0x012f0095]

Module ID (decimal)	Error ID (decimal)
303: SM301 safety module	149
Response (Lenze setting printed in bold)	
<input type="checkbox"/> None <input type="checkbox"/> System error <input type="checkbox"/> Error <input type="checkbox"/> Fault <input type="checkbox"/> Quick stop by trouble <input type="checkbox"/> Warning locked <input checked="" type="checkbox"/> Warning <input type="checkbox"/> Information	
Cause	Remedy
Channel B of input SD-In3 cannot be deactivated.	<ul style="list-style-type: none">• Check wiring at the safe input for short circuit.• Check configuration for the safe input.

Stuck at High at SD-In4, channel A [0x012f0096]

Module ID (decimal)	Error ID (decimal)
303: SM301 safety module	150
Response (Lenze setting printed in bold)	
<input type="checkbox"/> None <input type="checkbox"/> System error <input type="checkbox"/> Error <input type="checkbox"/> Fault <input type="checkbox"/> Quick stop by trouble <input type="checkbox"/> Warning locked <input checked="" type="checkbox"/> Warning <input type="checkbox"/> Information	
Cause	Remedy
Channel A of input SD-In4 cannot be deactivated.	<ul style="list-style-type: none">• Check wiring at the safe input for short circuit.• Check configuration for the safe input.

Stuck at High at SD-In4, channel B [0x012f0097]

Module ID (decimal)	Error ID (decimal)
303: SM301 safety module	151
Response (Lenze setting printed in bold)	
<input type="checkbox"/> None <input type="checkbox"/> System error <input type="checkbox"/> Error <input type="checkbox"/> Fault <input type="checkbox"/> Quick stop by trouble <input type="checkbox"/> Warning locked <input checked="" type="checkbox"/> Warning <input type="checkbox"/> Information	
Cause	Remedy
Channel B of input SD-In4 cannot be deactivated.	<ul style="list-style-type: none"> • Check wiring at the safe input for short circuit. • Check configuration for the safe input.

New parameter set deleted [0x012f00a0]

Module ID (decimal)	Error ID (decimal)
303: SM301 safety module	160
Response (Lenze setting printed in bold)	
<input type="checkbox"/> None <input type="checkbox"/> System error <input type="checkbox"/> Error <input type="checkbox"/> Fault <input type="checkbox"/> Quick stop by trouble <input type="checkbox"/> Warning locked <input type="checkbox"/> Warning <input checked="" type="checkbox"/> Information	
Cause	Remedy
The parameter set has been deleted via the safe parameterisation in the Engineer.	--

New safe parameter set loaded [0x012f00a1]

Module ID (decimal)	Error ID (decimal)
303: SM301 safety module	161
Response (Lenze setting printed in bold)	
<input type="checkbox"/> None <input type="checkbox"/> System error <input type="checkbox"/> Error <input type="checkbox"/> Fault <input type="checkbox"/> Quick stop by trouble <input type="checkbox"/> Warning locked <input type="checkbox"/> Warning <input checked="" type="checkbox"/> Information	
Cause	Remedy
New parameter set has been loaded via the safe parameterisation in the Engineer or by actuating the module button at the safety module.	--

Memory module - parameter set access error [0x012f00a2]

Module ID (decimal)	Error ID (decimal)
303: SM301 safety module	162
Response (Lenze setting printed in bold)	
<input type="checkbox"/> None <input type="checkbox"/> System error <input type="checkbox"/> Error <input type="checkbox"/> Fault <input type="checkbox"/> Quick stop by trouble <input type="checkbox"/> Warning locked <input checked="" type="checkbox"/> Warning <input type="checkbox"/> Information	
Cause	Remedy
An error has been detected when accessing the safe parameter set in the memory module.	Carry out a general reset. Transfer the safe parameter set into the safety module.

SM301 safety module | Parameter setting & configuration

Error messages

Different parameter sets [0x012f00a3]

Module ID (decimal)	Error ID (decimal)
303: SM301 safety module	163
Response (Lenze setting printed in bold)	
<input type="checkbox"/> None <input type="checkbox"/> System error <input type="checkbox"/> Error <input type="checkbox"/> Fault <input type="checkbox"/> Quick stop by trouble <input type="checkbox"/> Warning locked <input checked="" type="checkbox"/> Warning <input type="checkbox"/> Information	
Cause	Remedy
Different parameter sets on the memory module and on the safety module.	Transfer the safe parameter set via the Engineer into the safety module. Parameter set acceptance from the memory module using the module button at the safety module.

No safe parameter set safety module [0x012f00a4]

Module ID (decimal)	Error ID (decimal)
303: SM301 safety module	164
Response (Lenze setting printed in bold)	
<input type="checkbox"/> None <input type="checkbox"/> System error <input type="checkbox"/> Error <input type="checkbox"/> Fault <input type="checkbox"/> Quick stop by trouble <input type="checkbox"/> Warning locked <input checked="" type="checkbox"/> Warning <input type="checkbox"/> Information	
Cause	Remedy
Safety module has no parameter set.	Transfer safe parameter set via Engineer into safety module.

Defective parameter set safety module [0x012f00a5]

Module ID (decimal)	Error ID (decimal)
303: SM301 safety module	165
Response (Lenze setting printed in bold)	
<input type="checkbox"/> None <input type="checkbox"/> System error <input type="checkbox"/> Error <input type="checkbox"/> Fault <input type="checkbox"/> Quick stop by trouble <input type="checkbox"/> Warning locked <input checked="" type="checkbox"/> Warning <input type="checkbox"/> Information	
Cause	Remedy
Parameter set on safety module is defective.	Transfer safe parameter set via Engineer into safety module.

Memory module - parameter set format error [0x012f00a6]

Module ID (decimal)	Error ID (decimal)
303: SM301 safety module	166
Response (Lenze setting printed in bold)	
<input type="checkbox"/> None <input type="checkbox"/> System error <input type="checkbox"/> Error <input type="checkbox"/> Fault <input type="checkbox"/> Quick stop by trouble <input type="checkbox"/> Warning locked <input checked="" type="checkbox"/> Warning <input type="checkbox"/> Information	
Cause	Remedy
A format error has been detected in the parameter set of the memory module.	Recreate the parameter set format using the "General reset" function and transfer the parameter set via the Engineer into the safety module.

Parameter set plausibility error [0x012f00a7]

Module ID (decimal)	Error ID (decimal)
303: SM301 safety module	167
Response (Lenze setting printed in bold)	
<input type="checkbox"/> None <input type="checkbox"/> System error <input type="checkbox"/> Error <input type="checkbox"/> Fault <input type="checkbox"/> Quick stop by trouble <input type="checkbox"/> Warning locked <input checked="" type="checkbox"/> Warning <input type="checkbox"/> Information	
Cause	Remedy
The set parameters are not plausible with regard to each other.	Select the parameter set in the Engineer. Call the plausibility check and transfer the parameter set via the Engineer into the safety module.

Safety parameter set communicaton error [0x012f00a8]

Module ID (decimal)	Error ID (decimal)
303: SM301 safety module	168
Response (Lenze setting printed in bold)	
<input type="checkbox"/> None <input type="checkbox"/> System error <input type="checkbox"/> Error <input type="checkbox"/> Fault <input type="checkbox"/> Quick stop by trouble <input type="checkbox"/> Warning locked <input type="checkbox"/> Warning <input checked="" type="checkbox"/> Information	
Cause	Remedy
A communication error has occurred when loading the parameter set.	<ul style="list-style-type: none"> • Check whether memory module and safety module have been installed correctly. • Repeat parameter set transfer.

Module ID unequal effective safety address [0x012f00a9]

Module ID (decimal)	Error ID (decimal)
303: SM301 safety module	169
Response (Lenze setting printed in bold)	
<input type="checkbox"/> None <input type="checkbox"/> System error <input type="checkbox"/> Error <input type="checkbox"/> Fault <input type="checkbox"/> Quick stop by trouble <input type="checkbox"/> Warning locked <input checked="" type="checkbox"/> Warning <input type="checkbox"/> Information	
Cause	Remedy
The module ID in the parameter set does not correspond to the effective safety address.	Adjust module ID, safety address and DIP switch for setting the safety address.

Reference voltage error [0x012f00c0]

Module ID (decimal)	Error ID (decimal)
303: SM301 safety module	192
Response (Lenze setting printed in bold)	
<input type="checkbox"/> None <input type="checkbox"/> System error <input type="checkbox"/> Error <input type="checkbox"/> Fault <input type="checkbox"/> Quick stop by trouble <input type="checkbox"/> Warning locked <input checked="" type="checkbox"/> Warning <input type="checkbox"/> Information	
Cause	Remedy
The threshold value of the reference voltage in the safety module has been exceeded or fallen below the limit value.	Replace safety module.

SM301 safety module | Parameter setting & configuration

Error messages

6V voltage error [0x012f00c1]

Module ID (decimal)	Error ID (decimal)
303: SM301 safety module	193
Response (Lenze setting printed in bold)	
<input type="checkbox"/> None <input type="checkbox"/> System error <input type="checkbox"/> Error <input type="checkbox"/> Fault <input type="checkbox"/> Quick stop by trouble <input type="checkbox"/> Warning locked <input checked="" type="checkbox"/> Warning <input type="checkbox"/> Information	
Cause	Remedy
The threshold value of the 6 V voltage in the safety module has been exceeded or fallen below the limit value.	Replace safety module.

5V voltage error [0x012f00c2]

Module ID (decimal)	Error ID (decimal)
303: SM301 safety module	194
Response (Lenze setting printed in bold)	
<input type="checkbox"/> None <input type="checkbox"/> System error <input type="checkbox"/> Error <input type="checkbox"/> Fault <input type="checkbox"/> Quick stop by trouble <input type="checkbox"/> Warning locked <input checked="" type="checkbox"/> Warning <input type="checkbox"/> Information	
Cause	Remedy
The threshold value of the 5 V-reference voltage in the safety module has been exceeded or fallen below the limit value.	Replace safety module.

2.6V voltage error [0x012f00c3]

Module ID (decimal)	Error ID (decimal)
303: SM301 safety module	195
Response (Lenze setting printed in bold)	
<input type="checkbox"/> None <input type="checkbox"/> System error <input type="checkbox"/> Error <input type="checkbox"/> Fault <input type="checkbox"/> Quick stop by trouble <input type="checkbox"/> Warning locked <input checked="" type="checkbox"/> Warning <input type="checkbox"/> Information	
Cause	Remedy
The threshold value of the 2.6 V voltage in the safety module has been exceeded or fallen below the limit value.	Replace safety module.

Safe speed invalid [0x012f00d0]

Module ID (decimal)	Error ID (decimal)
303: SM301 safety module	208
Response (Lenze setting printed in bold)	
<input type="checkbox"/> None <input type="checkbox"/> System error <input type="checkbox"/> Error <input type="checkbox"/> Fault <input type="checkbox"/> Quick stop by trouble <input type="checkbox"/> Warning locked <input checked="" type="checkbox"/> Warning <input type="checkbox"/> Information	
Cause	Remedy
It is not possible to detect a safe speed.	<ul style="list-style-type: none">• Check encoder systems used.• Check communication between the drive and the safety module.

SSM: Encoder error [0x012f00d1]

Module ID (decimal)	Error ID (decimal)
303: SM301 safety module	209
Response (Lenze setting printed in bold)	
<input type="checkbox"/> None <input type="checkbox"/> System error <input type="checkbox"/> Error <input type="checkbox"/> Fault <input type="checkbox"/> Quick stop by trouble <input type="checkbox"/> Warning locked <input checked="" type="checkbox"/> Warning <input type="checkbox"/> Information	
Cause	Remedy
Error in safe speed monitoring via encoder.	Check configuration and connection of the encoder used.

SSM: Resolver error [0x012f00d2]

Module ID (decimal)	Error ID (decimal)
303: SM301 safety module	210
Response (Lenze setting printed in bold)	
<input type="checkbox"/> None <input type="checkbox"/> System error <input type="checkbox"/> Error <input type="checkbox"/> Fault <input type="checkbox"/> Quick stop by trouble <input type="checkbox"/> Warning locked <input checked="" type="checkbox"/> Warning <input type="checkbox"/> Information	
Cause	Remedy
Error in safe speed monitoring via resolver.	Check configuration and connection of the encoder used. Note: The use of the safety module in version VD1.4 with parameter set version 1.4 and the support of the resolver as motor encoder requires a specific firmware in the standard device of the 9400 product series.

SSM: Standard device data error [0x012f00d3]

Module ID (decimal)	Error ID (decimal)
303: SM301 safety module	211
Response (Lenze setting printed in bold)	
<input type="checkbox"/> None <input type="checkbox"/> System error <input type="checkbox"/> Error <input type="checkbox"/> Fault <input type="checkbox"/> Quick stop by trouble <input type="checkbox"/> Warning locked <input checked="" type="checkbox"/> Warning <input type="checkbox"/> Information	
Cause	Remedy
Error in safe speed monitoring. The data transferred by the standard device is faulty.	Contact Lenze.

SSM: Speed comparison error [0x012f00d4]

Module ID (decimal)	Error ID (decimal)
303: SM301 safety module	212
Response (Lenze setting printed in bold)	
<input type="checkbox"/> None <input type="checkbox"/> System error <input type="checkbox"/> Error <input type="checkbox"/> Fault <input type="checkbox"/> Quick stop by trouble <input type="checkbox"/> Warning locked <input checked="" type="checkbox"/> Warning <input type="checkbox"/> Information	
Cause	Remedy
The difference between the speed calculated internally and the speed values of the standard device exceeds the parameterised limit.	<ul style="list-style-type: none"> • Check configuration of the encoder system/s and gearbox factor. • Check tolerance value for the speed comparison (from SM301 V1.3). • If a digital position encoder is used, set code C00100 in the 9400 to "16".

SM301 safety module | Parameter setting & configuration

Error messages

SSM: Synchronisation error [0x012f00d5]

Module ID (decimal)	Error ID (decimal)
303: SM301 safety module	213
Response (Lenze setting printed in bold) <input type="checkbox"/> None <input type="checkbox"/> System error <input type="checkbox"/> Error <input type="checkbox"/> Fault <input type="checkbox"/> Quick stop by trouble <input type="checkbox"/> Warning locked <input checked="" type="checkbox"/> Warning <input type="checkbox"/> Information	
Cause	Remedy
Error in safe speed monitoring: Faulty synchronisation between the standard device and the safety module.	Contact Lenze.

SSM: Wrong PDO version [0x012f00d6]

Module ID (decimal)	Error ID (decimal)
303: SM301 safety module	214
Response (Lenze setting printed in bold) <input type="checkbox"/> None <input type="checkbox"/> System error <input type="checkbox"/> Error <input type="checkbox"/> Fault <input type="checkbox"/> Quick stop by trouble <input type="checkbox"/> Warning locked <input checked="" type="checkbox"/> Warning <input type="checkbox"/> Information	
Cause	Remedy
Error in safe speed monitoring: PDO version of data protocol is incompatible.	The SM301 V1.3 parameter set format requires operating system version 07.00.xx.xx or higher in the standard device.

7 Index

Symbols

"LS_Limiter" system block [14](#)
 "LS_SafetyModuleInterface" system block [14](#)

0-9

2.6V voltage error (error message) [126](#)
 5V voltage error (error message) [126](#)
 6V voltage error (error message) [126](#)

A

Actual speed - n_safe (C15402) [95](#)
 AIE [46](#)
 AIS [46](#)
 Application notes [8](#)

B

Basic function "Limiter" [14](#)

C

C15000 [76](#)
 C15003 [77](#)
 C15010 [77](#)
 C15011 [77](#)
 C15013 [77](#)
 C15014 [78](#)
 C15015 [78](#)
 C15016 [78](#)
 C15017 [78](#)
 C15030 [78](#)
 C15031 [79](#)
 C15032 [79](#)
 C15033 [80](#)
 C15034 [80](#)
 C15035 [80](#)
 C15036 [80](#)
 C15040 [81](#)
 C15051 [82](#)
 C15052 [83](#)
 C15055 [84](#)
 C15060 [84](#)
 C15100 [84](#)
 C15101 [85](#)
 C15111 [85](#)
 C15112 [85](#)
 C15113 [86](#)
 C15115 [87](#)
 C15200 [88](#)
 C15201 [88](#)
 C15202 [88](#)
 C15203 [88](#)
 C15204 [89](#)
 C15205 [89](#)
 C15300 [89](#)
 C15305 [89](#)
 C15306 [89](#)
 C15307 [90](#)
 C15308 [90](#)
 C15310 [90](#)
 C15311 [90](#)
 C15312 [90](#)
 C15315 [91](#)
 C15316 [91](#)
 C15317 [91](#)
 C15320 [91](#)
 C15321 [91](#)
 C15330 [92](#)
 C15331 [92](#)
 C15332 [92](#)
 C15333 [93](#)
 C15340 [93](#)
 C15341 [93](#)
 C15342 [93](#)
 C15343 [94](#)
 C15344 [94](#)
 C15350 [94](#)
 C15400 [94](#)
 C15401 [95](#)
 C15402 [95](#)
 C15405 [95](#)
 C15409 [95](#)
 C15410 [96](#)
 C15411 [96](#)
 C15420 [96](#)
 C15430 [96](#)
 C15500 [96](#)
 C15501 [97](#)
 C15502 [97](#)
 C15800 [97](#)
 C15801 [97](#)
 C15805 [98](#)
 C15810 [98](#)
 C15815 [99](#)
 C15820 [99](#)
 C15821 [99](#)
 C15822 [100](#)
 C15890 [100](#)
 C15891 [100](#)
 C15892 [101](#)
 C15893 [101](#)
 C15900 [103](#)
 C15901 [103](#)
 C15902 [103](#)

C214	18 , 75	0x012f0022	110
CAS	59	0x012f0023	110
Cascading (C15035)	80	0x012f0024	111
Circulation time exceeded (error message)	119	0x012f0025	111
Hardware or discrepancy error (error message)	120	0x012f0026	111
Stop delay (C15036)	80	0x012f0027	111
Cascading	59	0x012f0031	112
Change Password	74	0x012f0032	112
Command status (C15003)	77	0x012f0033	112
Communication error - standard device (error message)	109	0x012f0034	112
Compatibility mode	31	0x012f0035	112
Conventions used	6	0x012f0036	113
Current DIP switch display (C15101)	85	0x012f0037	113
Current error type (C15800)	97	0x012f0039	113
Current time (C15890)	100	0x012f003a	113
		0x012f003b	113
		0x012f003c	114
		0x012f0040	114
		0x012f0041	114
		0x012f0042	114
		0x012f0043	114
		0x012f0044	115
		0x012f0045	115
		0x012f0046	115
		0x012f0047	115
		0x012f0048	115
		0x012f0049	116
		0x012f004a	116
		0x012f0051	116
		0x012f0052	116
		0x012f0059	116
		0x012f005d	117
		0x012f005e	117
		0x012f0061	117
		0x012f0062	117
		0x012f0063	117
		0x012f0064	118
		0x012f0065	118
		0x012f0066	118
		0x012f0067	118
		0x012f0068	118
		0x012f0069	119
		0x012f006a	119
		0x012f006b	119
		0x012f006c	119
		0x012f006d	120
		0x012f006e	120
		0x012f006f	120
		0x012f0080	120
		0x012f0081	121
		0x012f0082	121
		0x012f0083	121
		0x012f0090	121
		0x012f0091	121
		0x012f0092	122
		0x012f0093	122
		0x012f0094	122
		0x012f0095	122
D			
Deactivated SD-In1 = high (error message)	113		
Deactivated SD-In2 = high (error message)	113		
Deactivated SD-In3 = high (error message)	113		
Deactivated SD-In4 = high (error message)	114		
Defective parameter set safety module (error message)	124		
Device password	74		
Different parameter sets (error message)	124		
Disconnecting paths	11		
Discrepancy error or functional test SD-In1 (error message)	112		
Discrepancy error or functional test SD-In2 (error message)	112		
Discrepancy error or functional test SD-In3 (error message)	112		
Discrepancy error or functional test SD-In4 (error message)	112		
Discrepancy time	39		
Download parameter set	68		
Drive-based safety	9		
E			
Effective safety address (C15112)	85		
E-mail to Lenze	134		
Error - internal disconnecting path (error message)	117		
Error - SD-Inx / CLx (error message)	116		
Error history (C15801)	97		
Error in PROFIsafe communication	25		
Error management	25		
Error number			
0x012f0001	109		
0x012f0002	109		
0x012f0003	109		
0x012f0010	109		
0x012f0011	110		
0x012f0021	110		

- 0x012f0096 [122](#)
- 0x012f0097 [123](#)
- 0x012f00a0 [123](#)
- 0x012f00a1 [123](#)
- 0x012f00a2 [123](#)
- 0x012f00a3 [124](#)
- 0x012f00a4 [124](#)
- 0x012f00a5 [124](#)
- 0x012f00a6 [124](#)
- 0x012f00a7 [125](#)
- 0x012f00a8 [125](#)
- 0x012f00a9 [125](#)
- 0x012f00c0 [125](#)
- 0x012f00c1 [126](#)
- 0x012f00c2 [126](#)
- 0x012f00c3 [126](#)
- 0x012f00d0 [126](#)
- 0x012f00d1 [127](#)
- 0x012f00d2 [127](#)
- 0x012f00d3 [127](#)
- 0x012f00d4 [127](#)
- 0x012f00d5 [128](#)
- 0x012f00d6 [128](#)
- Error states [25](#)
- ES [58](#)
- Export [30](#)
- Export group [30](#)
- F**
- F_CRC_Length error (error message) [115](#)
- F_Dest_Add = 0 or FFFFhex (error message) [114](#)
- F_Dest_Add unequal F address (error message) [114](#)
- F_SIL exceeds technical SIL (error message) [115](#)
- F_Source_Add = 0 or FFFFhex (error message) [114](#)
- F_WD_Time = 0 msec (error message) [114](#)
- F_WD_Time exceeded (error message) [110](#)
- Fail-safe state [11](#)
- Fault [25](#)
- Feedback to Lenze [134](#)
- Firmware compilation date (C15901) [103](#)
- Firmware product type (C15900) [103](#)
- Firmware version (C15902) [103](#)
- F-parameter error (error message) [111](#)
- Free assignment [39](#)
- Functional range of SM301 [12](#)
- G**
- General reset [73](#)
- General reset of the device [73](#)
- I**
- Import [30](#)
- Import group [30](#)
- Incorrect F-parameter version (error message) [115](#)
- Input delay [39](#)
- Input image (C15040) [81](#)
- Internal actual position value (C15820) [99](#)
- Internal actual speed value (C15405) [95](#)
- Internal error - AIE (error message) [113](#)
- Internal error - AIS (error message) [112](#)
- Internal error - module switch (error message) [113](#)
- Internal error, SS1 activated (error message) [109](#)
- Internal error, SS2 activated (error message) [109](#)
- Internal error, STO enable (error message) [109](#)
- L**
- Log function (C15891) [100](#)
- Log status (C15893) [101](#)
- Log time (C15892) [101](#)
- Logbook [26](#)
- Logout user [74](#)
- LS_Limiter [14](#)
- LS_SafetyModuleInterface [14](#), [19](#)
- M**
- Memory module - parameter set access error (error message) [123](#)
- Memory module parameter set format error (error message) [124](#)
- Module ID unequal effective safety address (error message) [125](#)
- Motor encoder status (C15401) [95](#)
- Motor encoder system (C15400) [94](#)
- Motor mounting direction (C15409) [95](#)
- N**
- New parameter set deleted (error message) [123](#)
- New Password [74](#)
- New safe parameter set has been loaded (error message) [123](#)
- No encoder system configured (error message) [119](#)
- No safe parameter set safety module (error message) [124](#)
- Number of resolver pole (C15430) [96](#)
- O**
- OMS [56](#)
 - Function at LOW level (C15202) [88](#)
 - Motion function (C15201) [88](#)
 - Stop function (C15200) [88](#)
- Output image (C15060) [84](#)
- P**
- Parameter CRC (C15011) [77](#)
- Parameter list [75](#)
- Parameter set creation time (C15013) [77](#)
- Parameter set plausibility error (error message) [125](#)
- Parameter set status (C15010) [77](#)
- Parameter set version (C15016) [78](#)
- Password file [67](#)

- Password management [74](#)
- Plausibility check [30](#), [68](#)
- Position encoder gearbox factor (C15501) [97](#)
- Position encoder mounting direction (C15502) [97](#)
- Position encoder system (C15500) [96](#)
- PROFIsafe [62](#)
- PROFIsafe - communication error (error message) [110](#)
- PROFIsafe - invalid data (error message) [111](#)
- PROFIsafe CRC1 error (error message) [115](#)
- PROFIsafe has left data exchange (error message) [111](#)
- PROFIsafe passivated (error message) [111](#)

- R**
- Ramp monitoring (SS1/SS2) [51](#)
- Read parameter set out of file [72](#)
- Read safe data from device [70](#)
- Reference voltage error (error message) [125](#)
- Required safety module (C214) [18](#), [75](#)
- Reserved (PROFIsafe standard) (error message) [115](#), [116](#)
- Response time of encoder monitoring (C15410) [96](#)
- Restart behaviour (C15300) [89](#)

- S**
- S bus
 - Configuration (C15100) [84](#)
 - Display control data (C15115) [87](#)
 - Filter control data (C15113) [86](#)
- Safe direction [60](#)
- Safe inputs [37](#)
- Safe operating stop (SOS) [49](#)
- Safe outputs [40](#)
- Safe parameter transfer [67](#)
- Safe speed invalid (error message) [126](#)
- Safe speed measurement [34](#)
- Safe transfer [67](#)
- Safety address (C15111) [85](#)
- Safety address invalid (0 or FFFHex) (error message) [110](#)
- Safety engineering [9](#)
- Safety instructions [8](#)
- Safety parameter set communication error (error message) [125](#)
- Safety status [11](#)
- SDI
 - Delay time (C15341) [93](#)
 - Error response (C15343) [94](#)
 - Maximum position change (C15344) [94](#)
 - Standard operation monitoring (C15340) [93](#)
 - Tolerance threshold (C15342) [93](#)
- SD-In [37](#)
- SD-In discrepancy time (C15033) [80](#)
- SD-In free assignment (C15032) [79](#)
- SD-In input delay (C15034) [80](#)
- SD-In sensor function (C15031) [79](#)
- SD-In sensor type (C15030) [78](#)
- SDIneg [60](#)
 - Wrong direction (error message) [118](#)
- SDIpos [60](#)
 - Wrong direction (error message) [118](#)
- SD-Out [40](#)
- SD-Out logic function (C15055) [84](#)
- SD-Out switching condition (C15051) [82](#)
- SD-Out switching condition (C15052) [83](#)
- SD-Out1 logic function [42](#)
- SD-Out1 switching condition [41](#)
- Sending safe data [68](#)
- Sensor function [38](#)
- Sensor type [38](#)
- Service code (C15805) [98](#)
- Service code (C15810) [98](#)
- Service code (C15815) [99](#)
- Service code (C15821) [99](#)
- Service code (C15822) [100](#)
- Service status [16](#)
- Short circuit - SD-Out (error message) [116](#)
- Sin/cos encoder PPR (C15420) [96](#)
- SLI
 - Safely limited increment (C15203) [88](#)
 - Safely limited increment exceeded (error message) [120](#)
 - Value of position change (C15204) [89](#)
- SLS [54](#)
 - Braking time Nlim (C15331) [92](#)
 - Limited speed Nlim (C15330) [92](#)
 - Permissible direction of movement (C15333) [93](#)
 - Response (n>Nlim) (C15332) [92](#)
- SLS, SMS
 - Max. response time (C15350) [94](#)
- SLS/SMS
 - Error stop not executed (error message) [118](#)
- SLS1
 - Nlim1 exceeded (error message) [117](#)
- SLS2
 - Nlim2 exceeded (error message) [117](#)
- SLS3
 - Nlim3 exceeded (error message) [118](#)
- SLS4
 - Nlim4 exceeded (error message) [118](#)
- SMI_SafetyModuleInterface [24](#)
- SMS [53](#)
 - Max. speed Nmax (C15320) [91](#)
 - Nmax exceeded (error message) [119](#)
 - Reaction (n>Nmax) (C15321) [91](#)
- SOS
 - Maximum position change (C15312) [90](#)
 - Tolerance limit exceeded (error message) [119](#)
 - Tolerance margin (delta p=0) (C15311) [90](#)
- Speed comparison tolerance. (C15411) [96](#)
- Speed measurement [34](#)

- Speed window (n=0) (C15310) [90](#)
 - SS1 [48](#)
 - STO delay after n=0 (C15307) [90](#)
 - SS1 mode (C15306) [89](#)
 - SS1, SS2
 - Ramp - S-ramp time (C15316) [91](#)
 - Ramp - start-offset (C15317) [91](#)
 - Ramp monitoring (C15315) [91](#)
 - Stopping time (C15305) [89](#)
 - SS1/SS2
 - Speed ramp exceeded (error message) [120](#)
 - Stopping time exceeded (error message) [117](#)
 - SS2 [49](#)
 - SS2 mode (C15308) [90](#)
 - SSE [47](#)
 - Emergency stop function (C15205) [89](#)
 - SSM
 - Encoder error (error message) [127](#)
 - Resolver error (error message) [127](#)
 - Speed comparison error (error message) [127](#)
 - Standard device data error (error message) [127](#)
 - Synchronisation error (error message) [128](#)
 - Wrong PDO version (error message) [128](#)
 - Standard password [74](#)
 - Status of safety functions (C15000) [76](#)
 - STO [47](#)
 - Stored module ID (C15017) [78](#)
 - Structure of safety instructions
 - [8](#)
 - Structure of the safety instructions [8](#)
 - Stuck at High at SD-In1, channel A (error message) [121](#)
 - Stuck at High at SD-In1, channel B (error message) [121](#)
 - Stuck at High at SD-In2, channel A (error message) [122](#)
 - Stuck at High at SD-In2, channel B (error message) [122](#)
 - Stuck at High at SD-In3, channel A (error message) [122](#)
 - Stuck at High at SD-In3, channel B (error message) [122](#)
 - Stuck at High at SD-In4, channel A (error message) [122](#)
 - Stuck at High at SD-In4, channel B (error message) [123](#)
 - Stuck at High SD-Out1, channel A (error message) [120](#)
 - Stuck at High SD-Out1, channel B (error message) [121](#)
 - Stuck at Low SD-Out1, channel A (error message) [121](#)
 - Stuck at Low SD-Out1, channel B (error message) [121](#)
 - Supported interfaces [17](#)
 - Synchronisation error - standard device (error message) [110](#)
 - System error [25](#)
- T**
- Table of attributes [104](#)
 - Test pulse error - internal disconnecting path (error message) [117](#)
 - Time of RTC parameter setting (C15014) [78](#)
 - Time of sec. parameter setting (C15015) [78](#)

U

- Unlock [30](#)
- Unlock group [30](#)
- Upload parameter set [70](#)

V

- Verify Password [74](#)

W

- Warning [25](#)
- Write parameter set into file [71](#)