

EDK82EVXXX  
13009523

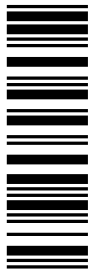

# Lenze

(D)

**Start-Hilfe**

(GB)

**Getting started**

(F)

**Aide à la mise en service**

(E)

**Ayuda para la puesta en marcha**

(I)

**Assistenza per la messa in funzione**

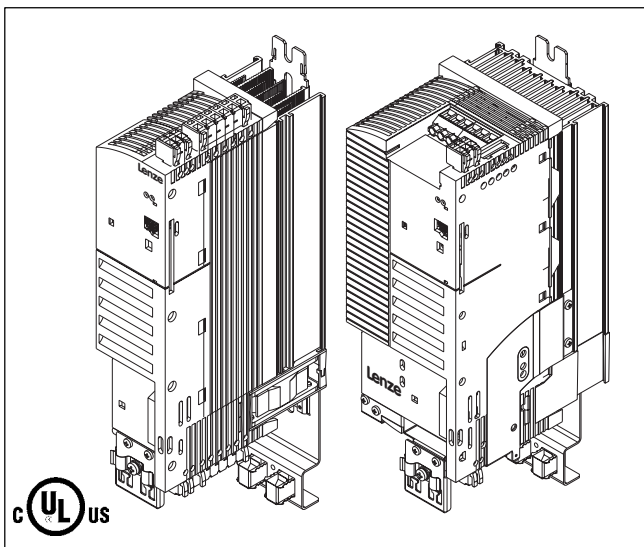

**8200 vector**

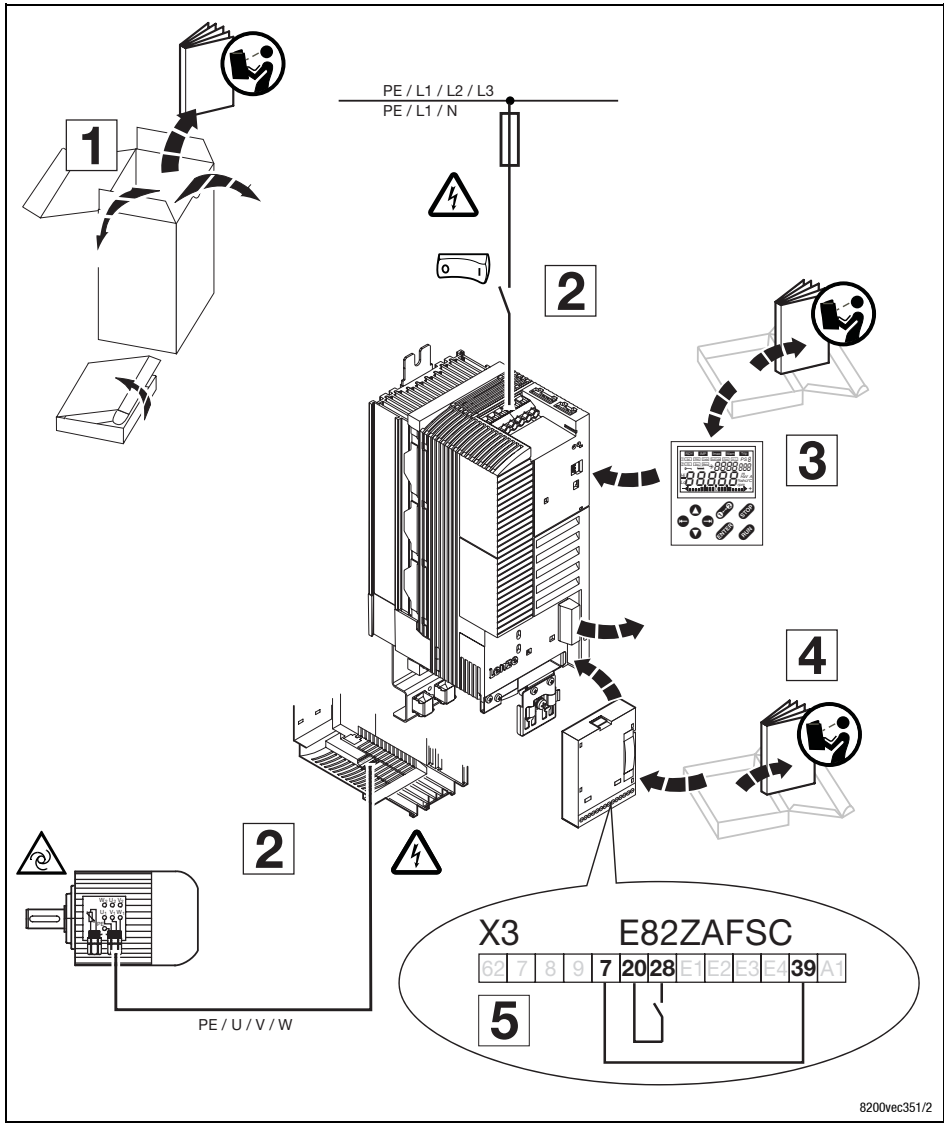

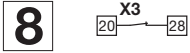
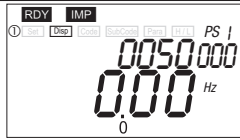
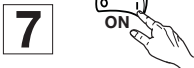

**9**

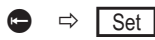
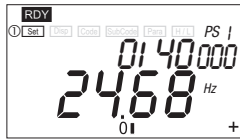

**10**

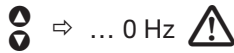
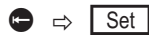

**11**

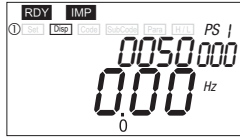
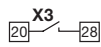

**12**

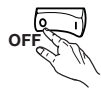

LED		Operating status
red ①	green ②	
off	on	Controller enabled
on	on	Mains switched on and automatic start inhibited
off	slowly blinking	Controller inhibited
off	fast blinking	Motor parameter identification
fast blinking	off	Undervoltage or overvoltage
slowly blinking	off	Error active, check under C0161

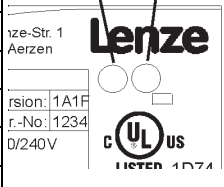

**1**

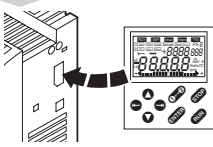

**2**

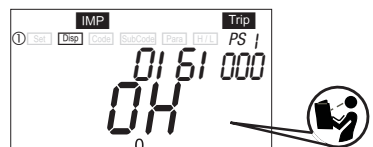

---

**3**



**4**



**5**



**6**



82vec355

Keypad	PC 1)	Error	Cause	Remedy
<b>oDEr</b>	0	No fault	-	-
<b>ccr</b> <b>Trip</b>	71	System fault	Strong interferences on control cables Ground or earth loops in the wiring	Shield control cables
<b>cE0</b> <b>Trip</b>	61	Communication fault to AIF (configurable in C0126)	Faulty transmission of control commands via AIF	Insert the communication module into the hand terminal
<b>cE1</b> <b>Trip</b>	62	Communication fault to CAN-IN1 with Sync control	CAN-IN1 object receives faulty data or communication is interrupted	<ul style="list-style-type: none"> <li>Plug-in connection - bus module ↔ Check FIF</li> <li>Check transmitter</li> <li>Increase monitoring time under C0357/1 if necessary</li> </ul>
<b>cE2</b> <b>Trip</b>	63	Communication error to CAN-IN2	CAN-IN2 object receives faulty data or communication is interrupted	<ul style="list-style-type: none"> <li>Plug-in connection - bus module ↔ Check FIF</li> <li>Check transmitter</li> <li>Increase monitoring time under C0357/2 if necessary</li> </ul>

Keypad	PC <sup>1)</sup>	Error	Cause	Remedy
<b>cE3</b> Trip	64	Communication error to CAN-IN1 with event or time control	CAN-IN1 object receives faulty data or communication is interrupted	<ul style="list-style-type: none"> <li>● Plug-in connection - bus module ↔</li> <li>● Check FIF</li> <li>● Check transmitter</li> <li>● Increase monitoring time under C0357/3 if necessary</li> </ul>
<b>cE4</b> Trip	65	BUS-OFF (many communication faults occurred)	Controller has received too many incorrect telegrams via the system bus and has been disconnected	<ul style="list-style-type: none"> <li>● Check whether bus terminator available</li> <li>● Check screen contact of the cables</li> <li>● Check PE connection</li> <li>● Check bus load, if necessary, reduce the baud rate</li> </ul>
<b>cE5</b> Trip	66	CAN Time-Out (configurable in C0126)	For remote parameter setting via system bus (C0370): Slave does not answer. Communication monitoring time exceeded.	<ul style="list-style-type: none"> <li>● Check system bus wiring</li> <li>● Check system bus configuration</li> </ul>
			For operation with application I/O: Faulty parameter setting of parameter set changeover	In all parameter sets the signal "parameter set changeover" (C0410/13, C0410/14) must be combined with the same source
			For operation with module in FIF: Internal fault	Contact Lenze
<b>cE6</b> Trip	67	Function module system bus (CAN) on FIF has set "Warning" or "BUS-OFF" (configurable in C0126)	CAN controller sets "Warning" or "BUS OFF"	<ul style="list-style-type: none"> <li>● Check whether bus terminator available</li> <li>● Check screen contact of the cables</li> <li>● Check PE connection</li> <li>● Check bus load, if necessary, reduce the baud rate</li> </ul>
<b>cE7</b> Trip	68	Communication fault during remote parameter setting via system bus (C0370) (configurable in C0126)	Participant does respond or is not available	<ul style="list-style-type: none"> <li>● Check whether bus terminator available</li> <li>● Check screen contact of the cables</li> <li>● Check PE connection</li> <li>● Check bus load, if necessary, reduce the baud rate</li> </ul>
			For operation with application I/O: Faulty parameter setting of parameter set changeover	In all parameter sets the signal "parameter set changeover" (C0410/13, C0410/14) must be combined with the same source
<b>EEr</b> Trip	91	External fault (TRIP-SET)	A digital input assigned to the TRIP-Set function has been activated.	Check external encoder
<b>Er-PO</b> ... <b>Er-P19</b> Trip	-	Communication abort between keypad and basic device	Various	Contact Lenze
<b>FRnI</b> Trip	95	E82ZMV fan module (only 8200 motec 3 ... 7,5 kW)	Fan module is defect	Replace fan module
	-	TRIP or warning configurable under C0608	Fan module is not connected	Connect fan module Check wiring
<b>HOS</b> Trip	105	Internal fault		Contact Lenze

Keypad	PC 1)	Error	Cause	Remedy
<b>IdI</b> Trip	140	Faulty parameter identification	Motor not connected	Connect motor
<b>LPI</b> Trip	32	Fault in motor phase (is displayed if C0597 = 1)	<ul style="list-style-type: none"> <li>● Failure of one/several motor phase(s)</li> <li>● Motor current too low</li> </ul>	<ul style="list-style-type: none"> <li>● Check motor cables</li> <li>● Check <math>V_{min}</math> boost</li> <li>● Connect motor to corresponding power or adapt the motor under C0599.</li> </ul>
<b>LPI</b>	182	Fault in motor phase (is displayed if C0597 = 2)		
<b>LU</b> IMP	-	DC-bus undervoltage	Mains voltage too low	Check mains voltage
			DC-bus voltage too low	Check supply module
			400 V controller connected to 240 V mains	Connect controller to the appropriate mains voltage
<b>OC1</b> Trip	11	Short circuit	Short circuit	<ul style="list-style-type: none"> <li>● Find reason for short circuit; check motor cable</li> <li>● Check braking resistor and cable for braking resistor</li> </ul>
			Excessive capacitive charging current of the motor cable	Use shorter motor cables with lower charging current
<b>OC2</b> Trip	12	Earth fault	Grounded motor phase	Check motor, check motor cable
			Excessive capacitive charging current of the motor cable	Use shorter motor cables with lower charging current
				Deactivate earth-fault detection for testing purposes
<b>OC3</b> Trip	13	Overload inverter during acceleration or short circuit	Acceleration time too short (C0012)	<ul style="list-style-type: none"> <li>● Increase acceleration time</li> <li>● Check drive selection</li> </ul>
			Defective motor cable	Check wiring
			Interturn fault in the motor	Check motor
<b>OC4</b> Trip	14	Overload controller during deceleration	Deceleration time set too short (C0013)	<ul style="list-style-type: none"> <li>● Increase deceleration time</li> <li>● Check size of external brake resistor</li> </ul>
<b>OC5</b> Trip	15	Controller overload in stationary operation	Frequent and long overload	Check drive selection
<b>OC6</b> Trip	16	Motor overload ( $I^2 \times t$ overload)	Motor is thermally overloaded, for instance, because of <ul style="list-style-type: none"> <li>● impermissible continuous current</li> <li>● frequent or too long acceleration processes</li> </ul>	<ul style="list-style-type: none"> <li>● Check drive selection</li> <li>● Check setting of C0120</li> </ul>
<b>OH</b> Trip	50	Heatsink temperature > +85 °C	Ambient temperature too high	Allow controller to cool and ensure better ventilation
<b>OH</b> Warn	-	Heatsink temperature > +80 °C	Heatsink very dirty	Clean heatsink
			Impermissibly high currents or too frequent and too long acceleration	<ul style="list-style-type: none"> <li>● Check drive selection</li> <li>● Check load, if necessary, replace defective bearings</li> </ul>
<b>OH3</b> Trip	53	PTC monitoring (TRIP) (is displayed if C0119 = 1 or 4)	Motor too hot because of excessive currents or frequent and too long accelerations	Check drive selection
			PTC not connected	Connect PTC or switch off monitoring

Keypad	PC 1)	Error	Cause	Remedy
<b>DH4</b> Trip	54	Controller overtemperature	Controller too hot inside	<ul style="list-style-type: none"> <li>● Reduce controller load</li> <li>● Improve cooling</li> <li>● Check fan in the controller</li> </ul>
<b>DHS1</b>	203	PTC monitoring (is displayed if C0119 = 2 or 5)	Motor too hot because of excessive currents or frequent and too long accelerations	Check drive selection
			PTC not connected	Connect PTC or switch off monitoring
<b>DU</b> IMP <b>DUE</b> Trip	-	DC-bus overvoltage (Warning or TRIP configurable under C0310)	Mains voltage too high	Check voltage supply
	22		Braking operation	<ul style="list-style-type: none"> <li>● Prolong deceleration times.</li> <li>● Operation with external brake resistor: <ul style="list-style-type: none"> <li>– Check dimensioning, connection and cable of the brake resistor.</li> <li>– Increase the deceleration times</li> </ul> </li> </ul>
			Earth leakage on the motor side	Check motor cable and motor for earth fault (disconnect motor from inverter)
<b>Pr</b> Trip	75	Faulty parameter transfer when using the keypad	All parameter sets are defective	It is absolutely necessary to repeat the data transfer or load the Lenze setting before enabling the controller.
<b>Pr1</b> Trip	72	Wrong PAR1 transfer when using the keypad.	PAR1 is defective.	
<b>Pr2</b> Trip	73	Wrong PAR2 transfer when using the keypad.	PAR2 is defective.	
<b>Pr3</b> Trip	77	Wrong PAR3 transfer when using the keypad.	PAR3 is defective	
<b>Pr4</b> Trip	78	Wrong PAR4 transfer when using the keypad.	PAR4 is defective	
<b>Pr5</b> Trip	79	Internal fault	EEPROM is defective	
<b>Pt5</b> Trip	81	Time fault during parameter set transfer	Data flow from keypad or PC interrupted, e. g. keypad was disconnected during transfer	It is absolutely necessary to repeat the data transfer or load the Lenze setting before enabling the controller.
<b>rSt</b> Trip	76	Faulty auto-TRIP reset	More than 8 fault messages in 10 minutes	Depends on the error message
<b>Sd5</b> Trip	85	Wire breakage analog input 1	Current at analog input < 4 mA at setpoint range 4 ... 20 mA	Close circuit at analog input
<b>Sd7</b> Trip		Wire breakage analog input 2		

1) LECOM-fault number, display in parameter setting program Global Drive Control (GDC)