

EDB2102EN  
00474677

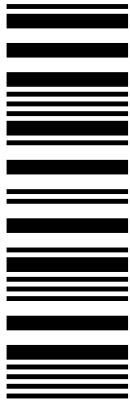

# Lenze

## *Operating Instructions*

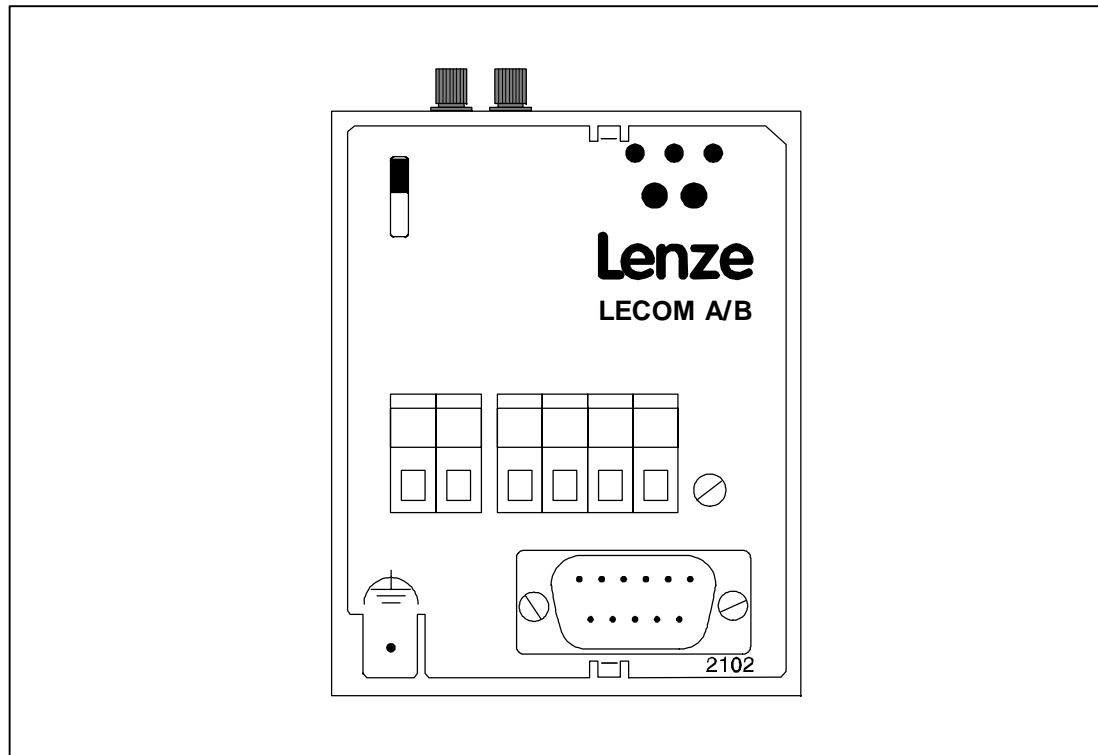

*Fieldbus module type 2102*

*RS232, RS485, optical fibre*

These Operating Instructions are valid for fieldbus modules with the following nameplates:

2102	IB.	2x.	3x.	V001	(RS232, RS485)
2102	IB.	2x.	3x.	V002	(RS485)
2102	IB.	2x.	3x.	V003	(Optical fibre)

In connection with the unit series as from the nameplate data:

820X	E.	2x.	1x.		(8201 - 8204)
820X	E./C.	2x.	1x.	Vxxx	(8201 - 8204)
821X	E.	2x.	2x.		(8211 - 8218)
821X	E./C.	2x.	2x.	Vxxx	(8211 - 8218)
822X	E.	1x.	1x.		(8221 - 8225)
822X	E.	1x.	1x.	Vxxx	(8221 - 8227)
824X	E.	1x.	1x.		(8241 - 8246)
824X	E./C.	1x.	1x.	Vxxx	(8241 - 8246)
82EV		VA	0x		8200 vector
82EV			1x	0x	8200 vector
93XX	E.	2x.	1x.		(9321 - 9333)
93XX	E./C.	2x.	1x.	Vxxx	(9321 - 9333)

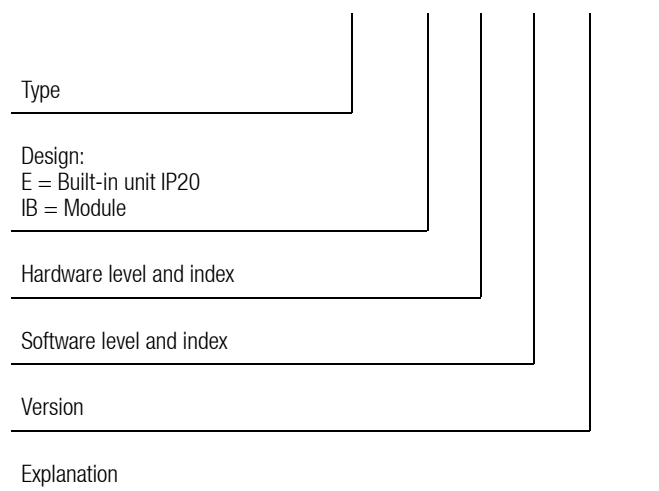

**Important:**

These Operating Instructions are only valid together with the corresponding Instructions for 82XX, 8200 vector or 93XX controllers.

Edition of:	01.10.2003		
-------------	------------	--	--

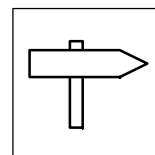

<b>1 Preface and general information</b> .....	<b>1-1</b>
1.1 About these Operating Instructions .....	1-1
1.1.1 Terminology used .....	1-1
1.1.2 What is new? .....	1-1
1.2 Packing list .....	1-1
1.2.1 Legal regulations .....	1-2
<b>2 Safety information</b> .....	<b>2-1</b>
2.1 Persons responsible for safety .....	2-1
2.2 General safety information .....	2-1
2.3 Layout of the safety information .....	2-2
<b>3 Technical data</b> .....	<b>3-1</b>
3.1 Features of the 2102 fieldbus module .....	3-1
3.2 General data and application conditions .....	3-1
3.3 Rated data .....	3-2
3.4 Dimensions .....	3-2
3.5 Communication times .....	3-3
<b>4 Installation</b> .....	<b>4-1</b>
4.1 Connections of the 2102 fieldbus module .....	4-1
4.1.1 Overview .....	4-1
4.1.2 Female plug for 9-pole SubD plug (LECOM-A/B) .....	4-2
4.1.3 Plug-in terminal for 4-pole male plug (LECOM-B) .....	4-2
4.1.4 Plug-in terminal for 2-pole male plug (external voltage supply) .....	4-2
4.2 Mechanical installation .....	4-3
4.3 Electrical installation .....	4-3
4.4 Wiring to a host .....	4-4
4.4.1 Wiring via RS232 (LECOM-A) .....	4-5
4.4.2 Wiring via RS485 (LECOM-B) .....	4-6
4.4.3 Wiring via optical fibres (LECOM-LI) .....	4-8

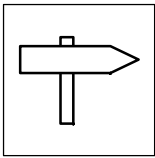

# Contents

<b>5</b>	<b>Commissioning</b>	<b>5-1</b>
<b>6</b>	<b>Parameter setting</b>	<b>6-1</b>
6.1	Parameter sets	6-1
6.1.1	82XX parameter sets	6-1
6.1.2	Parameter sets for 8200 vector	6-1
6.1.3	Parameter sets for 93XX	6-1
6.2	Meaning of individual parameters	6-2
6.2.1	Operating mode	6-2
6.2.2	LECOM unit address (C0009)	6-3
6.3	Special features when using the 82XX controller	6-4
6.3.1	Start with Ctrl. inhibit instead of QSP	6-4
6.3.2	Reduction of the response time of the interface	6-4
6.3.3	Communication monitoring	6-4
6.4	Special features when using the 820X controllers	6-5
6.4.1	Relative setpoint selection C0141 (parameter channel)	6-5
6.4.2	Special features when using the 820X V1.2 controller	6-5
6.5	Special notes for 821X, 822X, 824X controllers	6-6
6.6	Special notes when using 8200 vector controllers	6-6
<b>7</b>	<b>Troubleshooting and fault elimination</b>	<b>7-1</b>
<b>8</b>	<b>Appendix</b>	<b>8-1</b>
8.1	Accessories	8-1
8.1.1	Accessories for a host	8-1
8.1.2	Accessories for RS232 (LECOM-A)	8-1
8.1.3	Accessories for RS485 (LECOM-B)	8-2
8.1.4	Accessories for optical fibres (LECOM-LI)	8-2
8.2	Code table	8-3
8.3	LECOM-A/B protocol	8-16
8.3.1	General	8-16
8.3.2	RECEIVE	8-21
8.3.3	SEND	8-23
8.3.4	BROADCAST / MULTICAST	8-24
8.3.5	Monitoring of the slave response	8-24
8.3.6	Transmission faults	8-24
8.4	List of abbreviations	8-25
8.5	Glossary	8-26
8.6	Index	8-27

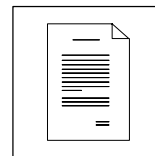

## 1 Preface and general information

### 1.1 About these Operating Instructions

- These Operating Instructions are intended for safety-relevant operations on and with the 2102 fieldbus module. They contain safety information which must be observed.
- All personnel working on and with the 2102 fieldbus module must have these Operating Instructions available and observe the information and notes relevant for them.
- The Operating Instructions must always be complete and perfectly readable.

These Operating Instructions inform about the most important technical data and the installation of the 2102 fieldbus module. They are only valid in combination with the Operating Instructions of the corresponding controller.

#### 1.1.1 Terminology used

<b>Controller</b>	In the following, the term "controller" is used for "93XX servo inverters" or "82XX frequency inverters".
<b>Drive system</b>	In the following the term "drive system" is used for drive systems with fieldbus modules and other Lenze drive components.
<b>Fieldbus module</b>	In the following text the term "fieldbus module" is used for "fieldbus module type 2102 RS232, RS485, optical fibre".
<b>Cxxx/y</b>	Subcode y of code Cxxx (e.g. C0410/3 = subcode 3 of code C0410)
<b>L-Cxxx/y</b>	Lenze code
<b>Xk/y</b>	Terminal strip Xk/terminal y (e.g. X3/28 = terminal 28 on terminal strip X3)
<b>(□)xx-yyy</b>	Cross reference (chapter - page)

#### 1.1.2 What is new?

Ident. no.	edition of	Important	Contents
391 845	08/1996	1st edition	
394 448	02/1997	replaces 391 845	<ul style="list-style-type: none"> <li>• extended by 2102.V904, 2102.V905, 2102.V906</li> <li>• Chapter 6.3</li> <li>• Editorially reviewed</li> </ul>
404 788	11/1998	replaces 394 448	Format change to DIN A4
417 816	10/2000	replaces 404 788	Adaptation to 8200 vector (all chapters)
474 677	10/2003	replaces 417 816	Change of company name

### 1.2 Packing list

Packing list	Important
<ul style="list-style-type: none"> <li>• 1 2102 fieldbus module with housing (enclosure IP20)</li> <li>• 1 M3 fixing screw</li> <li>• 1 two-pole male connector for voltage supply</li> <li>• 1 Short Instructions</li> </ul>	<p>After the delivery has received, check immediately whether the items supplied match the accompanying papers. Lenze does not accept any liability for deficiencies claimed subsequently.</p> <p><b>Claim</b></p> <ul style="list-style-type: none"> <li>• visible transport damage immediately to the forwarder</li> <li>• visible deficiencies/incompleteness immediately to your Lenze representative.</li> </ul>

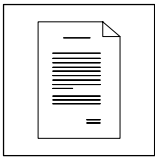

# Preface and general information

## 1.2.1 Legal regulations

<b>Labelling</b>	<b>Nameplate</b>	<b>CE identification</b>	<b>Manufacturer</b>
	Lenze 2102 fieldbus modules are unambiguously identified by their nameplates.	In compliance with the EC Low Voltage Directive	Lenze Drive Systems GmbH Postfach 10 13 52 D-31763 Hameln
<b>Application as directed</b>	<p><b>2102 fieldbus module</b></p> <ul style="list-style-type: none"> <li>Operate the fieldbus module only under the conditions prescribed in these Operating Instructions.</li> <li>The fieldbus module is an additional module and can be optionally attached to the Lenze controller series 820X, 821X, 822X, 8200 vector and 93XX. The 2102 fieldbus module links these Lenze controllers to superimposed hosts (PLC or PC) using the Lenze LECOM A/B/LI fieldbuses.</li> <li>The fieldbus module must be attached and electrically connected so that it complies with its function and does not cause any hazards when attached and operated as instructed.</li> <li>Observe all notes given in chapter "Safety information" (☞ 2-1).</li> <li>Please observe all information given in these Operating Instructions. This means: <ul style="list-style-type: none"> <li>Read these Operating Instructions carefully before you start to work with the system.</li> <li>These Operating Instructions must always be available during operation of the fieldbus module.</li> </ul> </li> </ul> <p><b>Any other use shall be deemed inappropriate!</b></p>		
<b>Liability</b>	<ul style="list-style-type: none"> <li>The information, data, and notes in these instructions met the state of the art at the time of printing. Claims referring to drive systems which have already been supplied cannot be derived from the information, illustrations, and descriptions given in these Operating Instructions.</li> <li>The specifications, processes, and circuitry described in these Operating Instructions are for guidance only and must be adapted to your own specific application. Lenze does not take responsibility for the suitability of the process and circuit proposals.</li> <li>The indications given in these Operating Instructions describe the features of the product without warranting them.</li> <li>Lenze does not accept any liability for damage and operating interference caused by: <ul style="list-style-type: none"> <li>disregarding these Instructions</li> <li>unauthorized modifications to the controller</li> <li>operating faults</li> <li>improper working on and with the controller</li> </ul> </li> </ul>		
<b>Warranty</b>	<ul style="list-style-type: none"> <li>Warranty conditions: see Sales and Delivery Conditions of Lenze Drive Systems GmbH.</li> <li>Warranty claims must be made immediately after detecting defects or faults.</li> <li>The warranty is void in all cases where liability claims cannot be made.</li> </ul>		
<b>Disposal</b>	<b>Material</b>	<b>recycle</b>	<b>dispose</b>
	Metal	●	-
	Plastic	●	-
	Printed-board assemblies	-	●
	Operating Instructions	●	



## 2 Safety information

### 2.1 Persons responsible for safety

#### Operator

- An operator is any natural or legal person who uses the drive system or on behalf of whom the drive system is used.
- The operator or his safety personnel is obliged
  - to ensure the compliance with all relevant regulations, instructions and legislation.
  - to ensure that only skilled personnel works on and with the 2102B fieldbus module.
  - to ensure that the personnel has the Operating Instructions available for all corresponding work.
  - to ensure that all unqualified personnel are prohibited from working on and with the drive system.

#### Qualified personnel

Qualified personnel are persons who - because of their education, experience, instructions, and knowledge about corresponding standards and regulations, rules for the prevention of accidents, and operating conditions - are authorized by the person responsible for the safety of the plant to perform the required actions and who are able to recognize potential hazards.

(Definition for qualified personnel to VDE 105 or IEC 364)

### 2.2 General safety information

- These safety notes do not claim to be complete. In case of questions and problems please contact your Lenze representative.
- At the time of delivery the fieldbus module meets the state of the art and ensures basically safe operation.
- The indications given in these Operating Instructions refer to the stated hardware and software versions of the fieldbus modules.
- The fieldbus module is hazardous if:
  - unqualified personnel works on and with the fieldbus module.
  - the fieldbus module is used inappropriately.
- The processing notes and circuit sections shown in these Operating Instructions are proposals which cannot be transferred to other applications without being tested and checked.
- Ensure by appropriate measures that neither personal injury nor damage to property may occur in the event of failure of the fieldbus module.
- The drive system must only be operated when no faults occur.
- Retrofittings, modifications, or redesigns are basically prohibited. Lenze must be contacted in all cases.
- The fieldbus module is electrical equipment intended for use in industrial high-power plants. The fieldbus module must be tightly screwed to the corresponding controller during operation. In addition, all measures described in the Operating Instructions of the controller used must be taken. Example: Fasten covers to ensure protection against contact.



## Safety information





### 2.3 Layout of the safety information

- All safety information have a uniform layout:
  - The icon characterizes the type of danger.
  - The signal word characterizes the severity of danger.
  - The note text describes the danger and gives information on how to prevent dangerous situations.



#### Signal word

Note

	Icons used		Signal words	
Warning of damage to persons		Warning of hazardous electrical voltage	<b>Danger!</b>	Warns of <b>impending danger</b> . Consequences if disregarded: Death or severe injuries.
		Warning of a general danger	<b>Warning!</b>	Warns of <b>potential, very hazardous situations</b> . Possible consequences if disregarded: Death or severe injuries.
Warning of damage to material			<b>Caution!</b>	Warns of <b>potential, hazardous situations</b> . Possible consequences if disregarded: Light or minor injuries.
			<b>Stop!</b>	Warns of <b>potential damage to material</b> . Possible consequences if disregarded: Damage of the controller/drive system or its environment.
Other notes			<b>Tip!</b>	This note designates general, useful notes. If you observe it, handling of the controller/drive system is made easier.



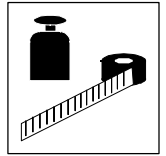

## 3 Technical data

### 3.1 Features of the 2102 fieldbus module

The 2102 fieldbus module has the following features:

- Different communication media:
  - RS232 (LECOM-A)
  - RS485 (LECOM-B)
  - Optical fibre (LECOM-LI)
- LECOM protocol V2.0
- The baud rate can be set to 1200, 2400, 4800, 9600 or 19200 baud (bit/s).
- Parameter setting via controller code numbers
- 3 Diagnostic LEDs
- Electrical isolation between control stage and power stage
- Electrical isolation of the I/O terminals of 821X, 8200 vector, 822X and 93XX
- Easy installation

### 3.2 General data and application conditions

Field	Values
Communication media	RS232 (LECOM-A): copper conductor RS485 (LECOM-B): copper conductor (LECOM-LI): optical fibre
Protocol	LECOM-A/B V2.0
Character Format	7 bit ASCII 1 Stop bit 1 Start bit 1 Parity bit (even)
Baud rate [bits/s]	1200, 2400, 4800, 9600, 19200
Ambient temperature	During operation: 0 to +50 °C Transport: -25 to +70 °C Storage: -25 to +55 °C
Permissible moisture	Class 3K3 to EN 50178 (without condensation, average relative humidity 85%)
24-V-DC-Voltage supply	<ul style="list-style-type: none"> <li>• 820X / 8200 vector (observe chapter 4.3): only external supply</li> <li>• 821X / 822X / 8200 vector (observe chapter 4.3) / 93XX: internal or external supply</li> </ul>

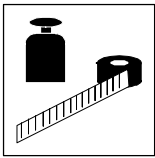

## Technical data

### 3.3 Rated data

	2102IB.V001	2102IB.V002	2102IB.V003
Communication media	RS232 (LECOM-A) RS485 (LECOM-B)	RS485 (LECOM-B)	Optical fibre (LECOM-LI)
Current consumption	80 mA	60 mA	70 mA
External supply (terminals 39/59)	$V = 24 \text{ V DC}$ $V_{\text{RMS}} = 15 \text{ TO } 30 \text{ V DC}; W = 5 \%$ $V_{\text{RMS}} = 20 \text{ TO } 25 \text{ V DC}; W = 48 \%; V_{\text{SS}} < 35 \text{ V}$		

#### 2102IB.V001 / 2102IB.V002 / 2102IB.V003:

		Rated insulation voltage	Type of insulation
Insulation voltages for bus systems	• to PE	50 V AC	no electrical isolation
	• for external supply (terminals 39/59)	-	no electrical isolation
	• for power stage		
	– 820X / 821X	270 V AC	basic insulation
	– 822X / 8200 vector	270 V AC	double basic insulation
	– 93XX	270 V AC	double basic insulation
	• for control terminals		
	– 820X / 8200 vector (with internal supply)	-	no electrical isolation
– 8200 vector (with external supply)	100 V AC	basic insulation	
– 821X	50 V AC	electrical isolation	
– 822X	270 V AC	basic insulation	
– 93XX	270 V AC	basic insulation	
• for external bus systems	50 V AC	electrical isolation	
Degree of pollution	VDE 0110 part 2 pollution degree 2		

### 3.4 Dimensions

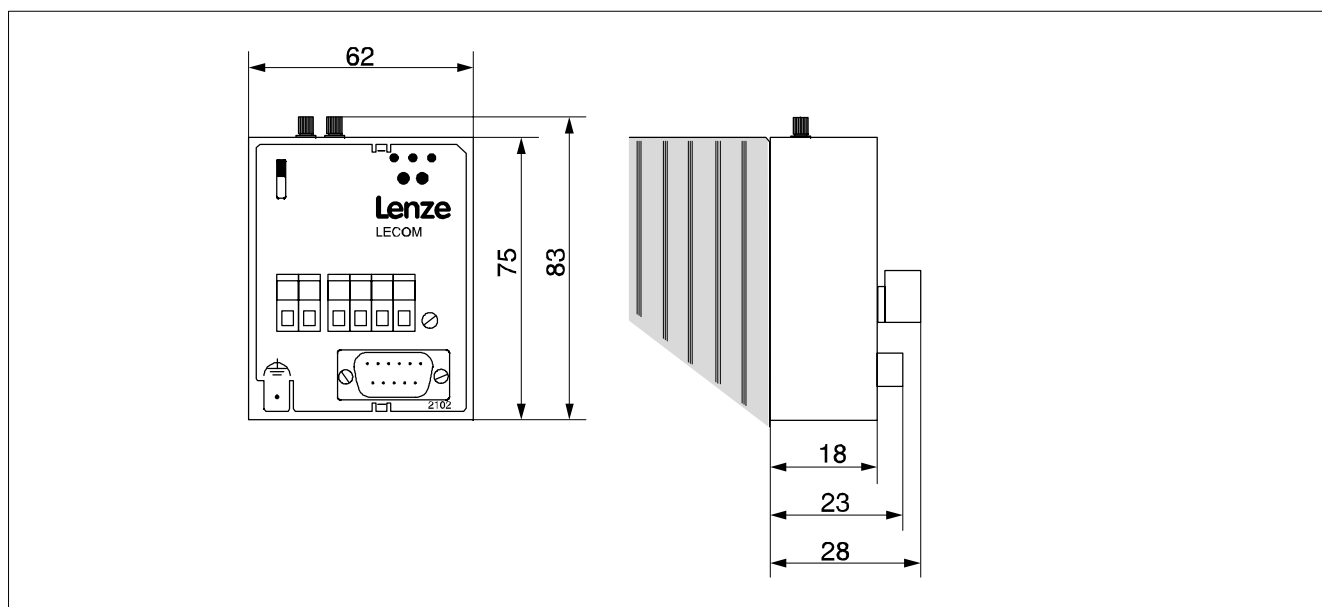
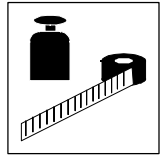

Fig. 3-1 Dimensions of the 2102 fieldbus module (all dimensions in mm)



## 3.5 Communication times

The time required for communication can be displayed as a sequence of processing steps (with corresponding times).

Step	Explanation
t0	User program in host starts request to the controller (e.g. controller enable with C0040=1)
t1	Software driver (e.g. LECOM-S5) in host converts request data into LECOM-A/B protocol V2.0 and starts the transmission.
t2	Serial data transfer to the controller (telegram time)
t3	Data receipt of the controller: Processing of request and start of response
t4	Response data to host are being transmitted (telegram time)
t5	Software driver in host evaluates the response, i.e. the response is converted into the format of the user program.
t6	Application program in host gets the result

The time sections t2, t4 and t3 are described in detail in the following:

### Telegram time (t2 + t4)

The telegram time comprises the serial communication from the host to the controller (t2) and the corresponding response from the controller (t4). The time depends on the telegram type and the baud rate set under C0125.

	Baud rate [bits/s] (C0125)				
	1200	2400	4800	9600	19200
Single character transmission time [ms] (1 character = 10 bit; see chapter 3.2)	8.4	4.2	2.1	1	0.52

Telegram type SEND (sends data to drive):

	Baud rate [bits/s] (C0125)				
	1200	2400	4800	9600	19200
t2: Standard [ms] (parameter value = 9 characters)	150	75	37.5	18.8	9.4
Addition for extended addressing [ms]	41.6	20.8	10.4	5.2	2.6

Telegram type RECEIVE (reads data from drive):

	Baud rate [bits/s]				
	1200	2400	4800	9600	19200
Standard [= t4] (Parameter value = 9 characters) [ms]	166.7	83.3	41.7	20.8	10.4
Addition for extended addressing [ms]	83.3	41.7	20.8	10.4	5.2

If more or fewer than 9 characters are transmitted as telegram data, take the corresponding character-transmission times into account.

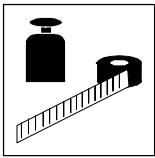

## Technical data

### Processing time in the controller (t3)

The processing time in the controller depends on the controller type and the code numbers. This is shown in the following table:

Code numbers	Processing time (2102 + controller) [ms]		
	820X	821X/8200 vector/822X	93XX
C0046, C0135	35 <sup>1)</sup>	20	20 <sup>3)</sup>
C0050, C0150	35	20	20
C0068	70	30	30
Write other code numbers	230	20 <sup>2)</sup>	20 <sup>4)</sup>
Read other code numbers	55	20	20

- 1) 35 ms is valid for C0001 = 3. If C0001 = 1 and you write under C0046, access is also possible. However, the processing time is prolonged to 70 ms.
- 2) For immediately following write-access procedures, the response times may be up to 50ms.
- 3) The code number C0046 can only be read. Use a free code number (e. g. C0141) to select a setpoint. For this, refer to the 93XX Manual.
- 4) This is a typical value. For some codes, the processing times may be longer. For this, refer to the 93XX Manual.

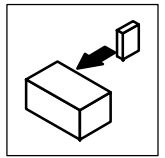

## 4 Installation

### 4.1 Connections of the 2102 fieldbus module

#### 4.1.1 Overview

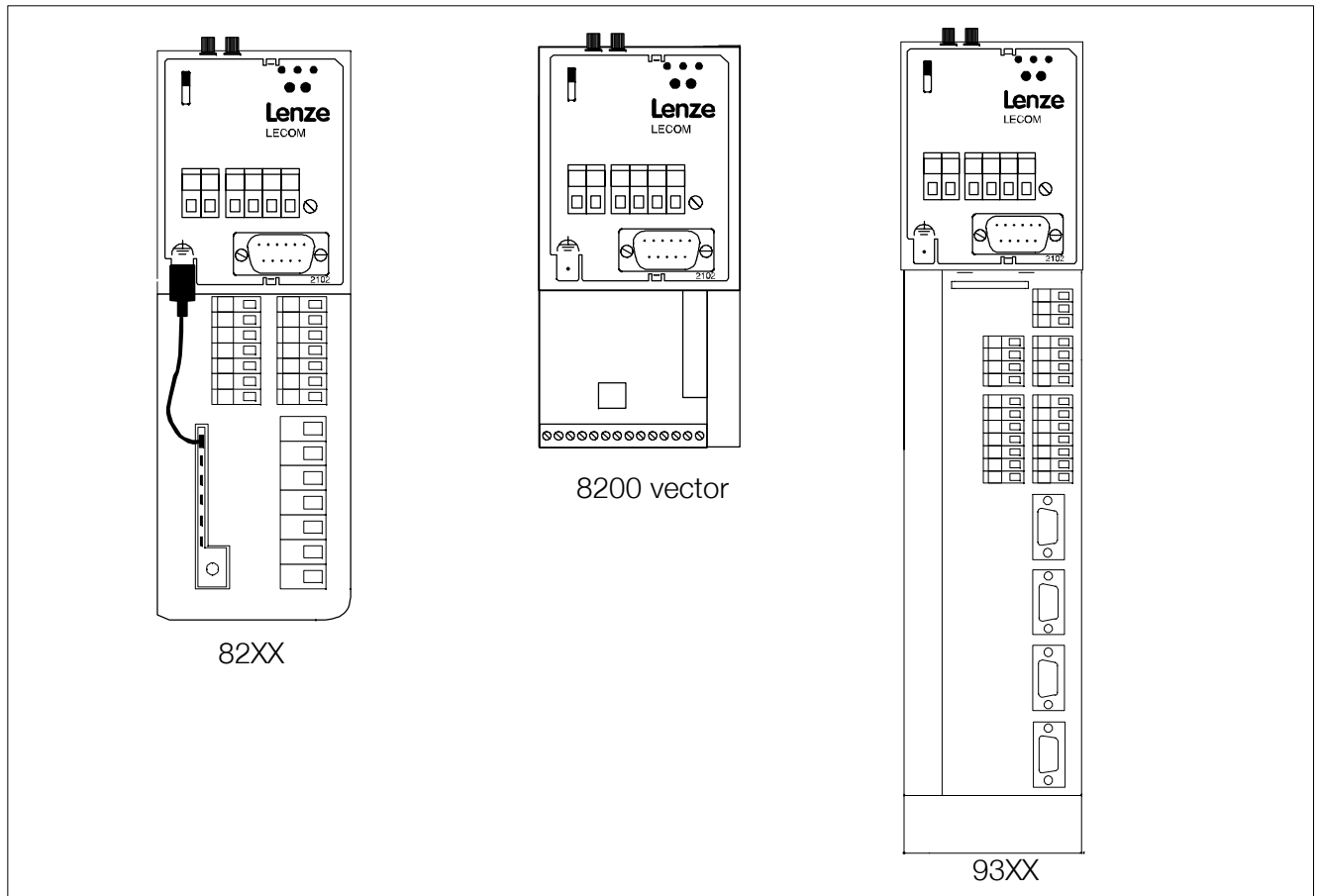
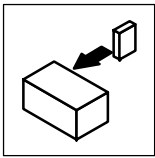

Fig. 4-1 82XX, 8200 vector and 93XX controllers (with fieldbus module 2102)



# Installation

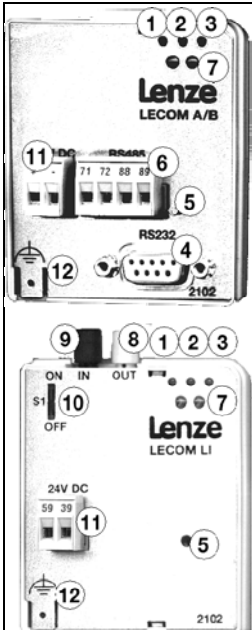

Fig. 4-2

Pos.	Name/Meaning	Note
1	<b>Green bus LED</b> (voltage supply) ON: Fieldbus module has connected with the controller. BLINKING: 2102 fieldbus module is supplied with voltage but is not connected to the controller (controller is switched off, in initialization or not available).	
2	<b>Yellow RxD-LED</b> For receiving signal: BLINKING: Drive unit receives telegram	
3	<b>Yellow TxD-LED</b> For sending signal: BLINKING: Drive unit transmits response	
4	9-pole SubD female plug for the RS232/RS485 interface	only with 2102IB.V901/2102.V904
5	Fixing screw	
6	4-pole clamp-plug connection for RS485 interface	only with 2102IB.V901/2102.V904 and 2102IB.V902/2102.V905
7	Operating status display for the controller	
8	Optical-fibre transmitter (white)	only with 2102IB.V903/2102.V906
9	Optical-fibre receiver (black)	only with 2102IB.V903/2102.V906
10	Switch S1 for optical-fibre transmission rate: OFF: normal transmission rate (0 to 40m) ON: = high transmission rate (10 to 66m)	only with 2102IB.V903/2102.V906
11	Connection for external voltage supply (24 V DC $\pm$ 10 %)	
12	PE connection (only for 82XX)	
-	RS 485 cable (no drawing)	only with 2102IB.V901/2102.V904 and 2102IB.V902/2102.V905

## 4.1.2 Female plug for 9-pole SubD plug (LECOM-A/B)

Pin	Name	Input/output	Explanation
1	-	-	Not assigned
2	RxD	Input	Data receiving wire RS232
3	TxD	Output	Data transmitting wire RS232
4	DTR	Output	Transmission control RS232
5	GND	-	Reference potential
6	DSR	Input	Not assigned RS232
7	T/R(A)	Input/output	RS485
8	T/R(B)	Input/output	RS485
9	Vcc5	Output	Supply +5 V / 10 mA

## 4.1.3 Plug-in terminal for 4-pole male plug (LECOM-B)

Pin	Name	Input/output	Explanation
71	T/R(B)	Input/output	RS485
72	T/R(A)	Input/output	RS485
88	S-C	-	Capacitive screening to PE
89	S	-	Direct screening to PE

## 4.1.4 Plug-in terminal for 2-pole male plug (external voltage supply)

Pin	Name	Input/output	Explanation
39/ -	GND24	-	Reference potential for external supply
59/ +	Vcc24	Input	External supply 15 to 30 V DC (see chapter 4.3)

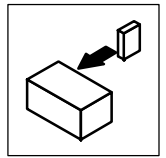

## 4.2 Mechanical installation

- Remove the keypad from the front of the controller if it is attached.
- Attach the 2101 fieldbus module to the front of the controller. Use the fixing screw, which is part of the delivery package, to secure the fieldbus module (see Fig. 4-1, pos. 3) (□ 1-1).



### Stop!

Tighten the fixing screw to ensure adequate PE connection of the 2102 fieldbus module.

## 4.3 Electrical installation

- The communication of controllers 820X and 821X may be disturbed by electromagnetic radiation. Use an additional PE cable to ensure safe communication (see Fig. 4-1 pos. 13). This is not necessary with the controllers 822X and 93XX.



### Caution!

The bus system continues operation even if the 2102 fieldbus system is disconnected from the power supply because of an error.

If this is the case, the controller cannot be reached by the host.



### Stop!

The polarity of the voltage supply must not be reversed, otherwise, the 2102 fieldbus module will be destroyed !

- Voltage supply:
  - external 24 V (15 to 30 V) via plug-in connectors 39 (-) / 59 (+)  
or
  - internal via the controller (connection by plugging it on).  
With 820X it is not possible to have an internal voltage supply via the controller.

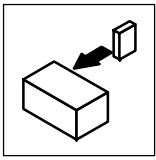

## Installation



### Note!

#### Internal voltage supply of the fieldbus module connected to a 8200 vector

Controllers with an extended AIF interface (front of the 8200 vector) can be internally supplied. The part of the drawing highlighted with grey shows the jumper position.

In Lenze setting, the fieldbus module is not internally supplied.

For internal voltage supply, put the jumper in the position indicated below.

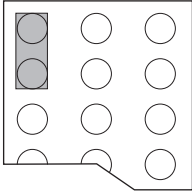
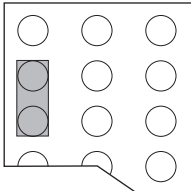
Lenze setting (only external voltage supply)	Internal voltage supply
	

## 4.4

### Wiring to a host

This chapter informs you about networking the 2102 fieldbus module using the bus systems RS232 (LECOM-A), RS485 (LECOM-B) or optical fibres (LECOM-LI).

The accessories requires are listed in chapter 8.1.



### Danger!

- An additional **electrical isolation** is required if
  - a 820X, 821X or 8200 vector controller will be connected to a host
  - a safe electrical isolation (double basic insulation) to VDE 0160 is required.
- Please observe the following:
  - RS232:  
The electrical isolation of the RS232 interface (LECOM-A) can be achieved by two 2101IB level converters or another RS232 electrical isolation.
  - RS485:  
With RS485 (LECOM-B), the 2101IB level converter should be installed to the host if it is not equipped with an appropriately isolated interface.
  - Optical fibres:  
If two controllers are connected via optical fibres (LECOM-LI) they are always isolated.
- For wiring, the electrical isolation of the supply voltage must be taken into account.

The controllers 822X and 93XX are equipped with a double basic insulation to VDE 0160, additional electrical isolation is therefore not necessary.



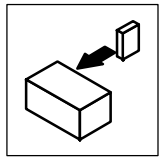

## 4.4.1 Wiring via RS232 (LECOM-A)

The following figure schematically shows the connection to a host (here: PC) via RS232 (LECOM-A).

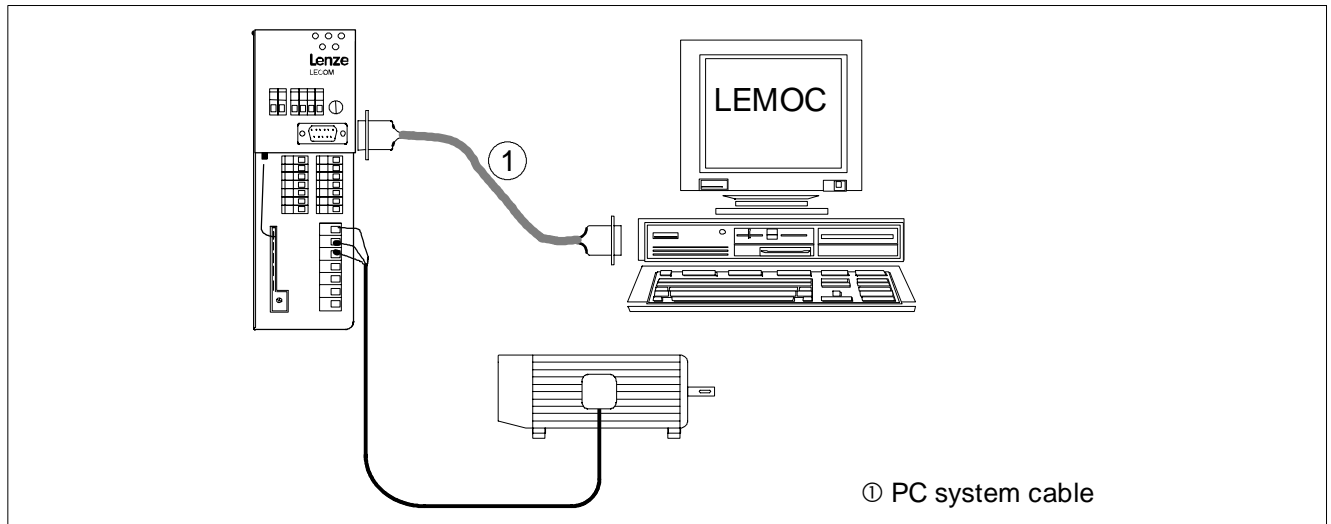

Fig. 4-3 Wiring for RS232 (LECOM-A)

Wiring features for RS232 (LECOM-A):

<b>Type</b>	<b>2102IB.V001</b>
Communication media	RS232
Network topology	Point-to-point
Possible number of controllers	1
Maximum cable length	15 m
Maximum baud rate	19200 bit/s



### Note!

We recommend the use of ready-made PC system cables for wiring (see chapter 8.1.2).

Wire the PC system cables as described:

1. Use metallic SubD connector shells and connect both ends of the screen to the connector shells.
2. Connect the pins as follows:

Unit	Connection element	Pin-No. (name)		
2102 fieldbus module	9-pole SubD plug	2 (RxD)	3 (TxD)	5 (GND)
Host (PC, PLC, etc.)	9-pole SubD female plug 25-pole SubD female plug.	3 (TxD)	2 (RxD)	5 (GND)
		2 (TxD)	3 (RxD)	7 (GND)

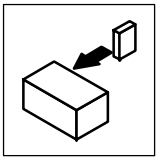

# Installation

## 4.4.2 Wiring via RS485 (LECOM-B)

The following figure schematically shows the connection to a host (PC or PLC) via RS485 (LECOM-B).

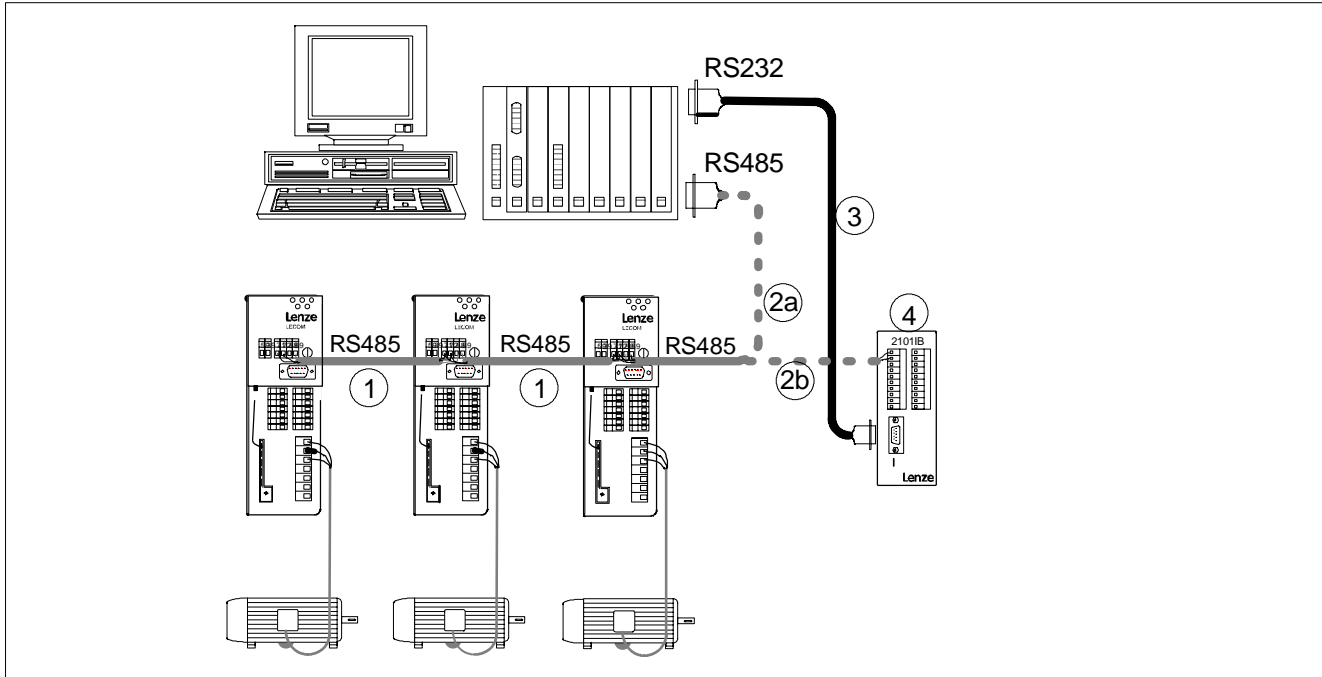

Fig. 4-4 Wiring for RS485 (LECOM-B)

- |   |  |
|---|--|
| ① | Interface cable RS485  |
| ② | Optional host connection<br>a) directly RS485<br>b) RS232 via interface converter 2101IB |
| ③ | PC system cable  |
| ④ | 2101IB interface converter   |



### Note!

- We recommend the use of appropriate accessories (see chapter 8.1.3).
- Please do not use any other but a shielded and twisted cable for wiring the RS485 interface cable.

Wiring features for RS485 (LECOM-B):

Type	2102IB.V002
Communication media	RS485 (2 wires)
Network topology	Line
Possible number of controllers	31
Maximum cable length	1200 m
Maximum baud rate	19200 bit/s

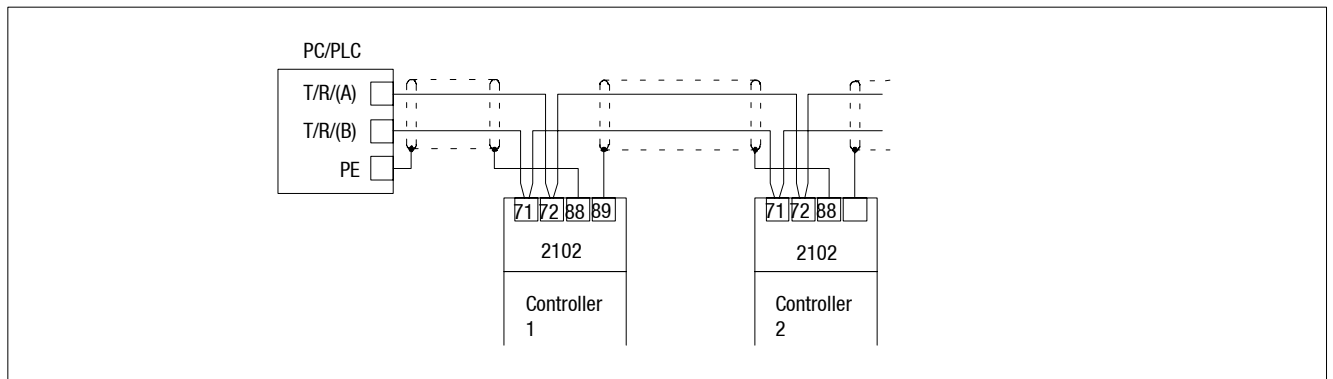
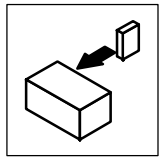

Fig. 4-5 Connection to the host (PC/PLC)

### Connection between two controllers (cable 1 in Fig. 4-4):

- Connect the cable shield with terminal 89 (direct PE) of one fieldbus module and terminal 88 (capacitive PE) of the other fieldbus module (Fig. 4-5). This method prevents currents flowing through the cable screens.
- Connect the terminals 71 and 72 between the fieldbus modules via paired cables (e.B. green and yellow).

### Direct connection to the host (cable 2a in Fig. 4-4)

- Connect the host cable screen to PE and the controller cable screen to terminal 88. This method prevents currents flowing through the cable screens.

### Connection to the 201IB interface converter (cable 2b in Fig. 4-4):

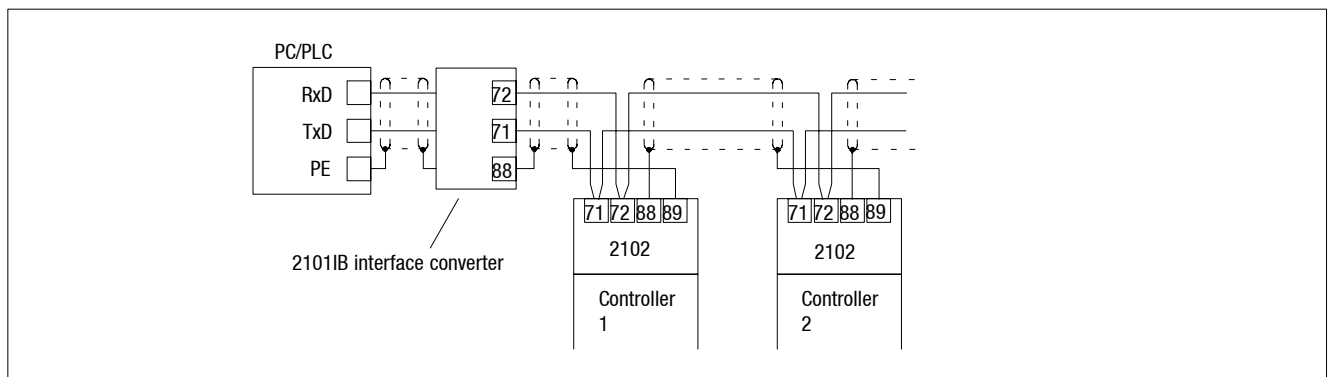
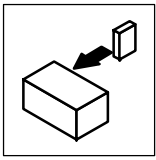

Fig. 4-6 Connection to the 2101IB interface converter

- Connect the cable shield with terminal 89 (direct PE) of the last controller and terminal 88 (capacitive PE) of the interface converter (Fig. 4-6). This method prevents currents flowing through the cable screens.



# Installation

## 4.4.3 Wiring via optical fibres (LECOM-LI)

The following figure schematically shows the connection to a host (PC or PLC) via optical fibre (LECOM-LI).

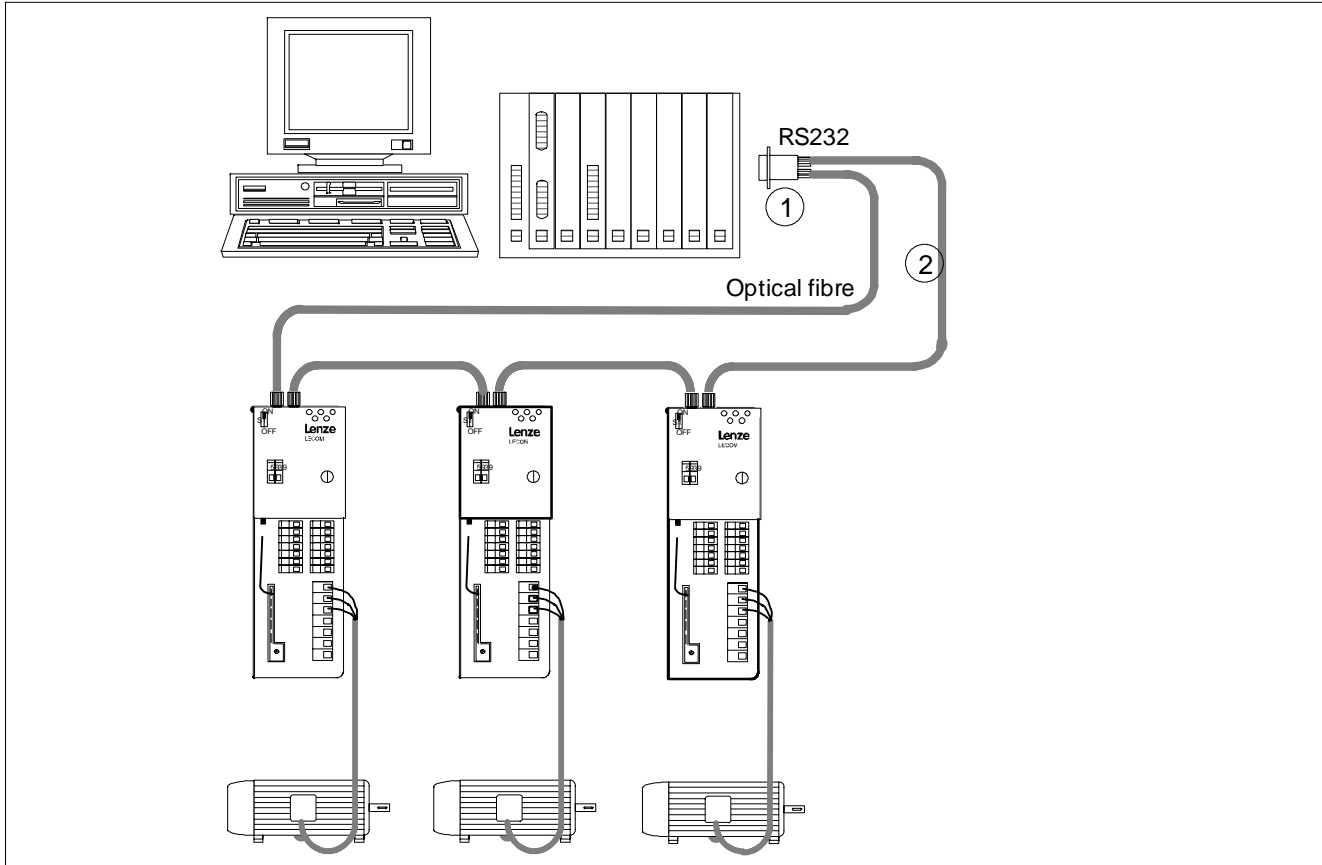

Fig. 4-7 Wiring for optical fibres (LECOM-LI)

- ① RS232/optical fibre-converter for hosts
- ② Optical-fibre cable



### Note!

We recommend the use of appropriate accessories (see chapter 8.1).

Wiring features for optical fibres (LECOM-LI):

Type	2102IB.V003
Communication media	Optical fibre (plastic)
Network topology	Ring
Possible number of controllers	52
Maximum cable length	0 to 40 m for standard transmission rate (S1 = OFF) 10 to 66 m for high transmission rate (S1 = ON)
Maximum baud rate	19200 bit/s

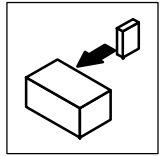

For wiring, optical-fibre cables must be prepared:

<b>Optical-fibre cable preparation</b>	<p>The preparation of the optical-fibre cables does not require special tools.</p> <ol style="list-style-type: none"> <li>1. Cut cable to length on a rigid surface, e.g. using a knife.</li> <li>2. For optical-fibre cables with PUR sheaths (read) remove approx. 20 mm (for cables with PE sheaths, removal is not required).</li> </ol>
	<div style="display: flex; align-items: center;"> <div style="border: 1px solid black; padding: 2px; margin-right: 10px;"> <b>i</b> </div> <div> <p>With unpolished optical-fibre ends, the max. length is reduced by approx. 20 %. Therefore, polish the cable end of the optical fibre (grain: P1000).</p> </div> </div>
<b>Installation of optical-fibre cables</b>	<ol style="list-style-type: none"> <li>1. Open pinch-screw joint of the plug.</li> <li>2. Insert the cable end into the optical-fibre connection as far as possible.</li> <li>3. Tighten the pinch-screw joint.</li> </ol>
<b>Installation of the optical-fibre ring (Fig. 4-7)</b>	<div style="display: flex; align-items: center;"> <div style="border: 1px solid black; padding: 2px; margin-right: 10px;"> <b>i</b> </div> <div> <p>The bending radius should be at least 30 mm, otherwise the max. optical-fibre cable length will be reduced by typically 50 % per bend.</p> </div> </div> <ol style="list-style-type: none"> <li>1. Connect the white optical-fibre connector (transmitter, TxD) on the host to the black optical-fibre connector (receiver, RxD) on the next controller.</li> <li>2. Connect the white optical-fibre connector on the controller to the black optical-fibre connector on the next controller.</li> <li>3. Connect the white optical-fibre connector on the last controller to the black optical-fibre connector on the host.</li> <li>4. If the optical-fibre cables are longer than 40 m, select the high transmission rate. Switch S1 to ON position. This provides a maximum cable length of 66 m (with a damping of 150 dB/km).</li> </ol>



## Note!

Further information on LECOM-LI can be obtained from the Operating Instructions LECOM-LI (see chapter 8.1.4).

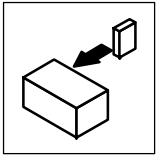

## ***Installation***

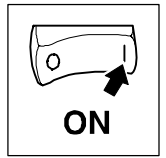

## 5 Commissioning



### Stop!

Before switching on the mains voltage check the wiring for completeness, short circuit and earth fault.

When switching on the unit for the first time, observe the following sequence:

1. Switch on the controller and, if necessary, the external supply of the 2102 fieldbus module.
  - The operating status display for the controller (Fig. 4-2, Fig. 4-2 pos. 5) must be on or blinking.
  - The green LED (Fig. 4-2, Fig. 4-2 pos. 8) must be on. If this is not the case, see chapter 7.
2. The transmission speed or LECOM baud rate (C0125) is factor set to 9600 baud. If you require a different value, adjust it via the operating unit.
3. Set LECOM unit address (C0009; see description in chapter 6.2.2) via the operating unit or via the host (default setting: 1).
  - If several controllers are interconnected, the addressing via C0009 of the controller must be different than that of the others. This is the only way for the host to reach a certain controller.
  - The values 00, 10, 20, 30, ..., 90 must not be set since they are reserved for group addressing.



### Tip!

The code numbers C0009 (LECOM controller address) and C0125 (LECOM baud rate) can also be input via LECOM. Please observe that the parameters for the host must be adapted. If C0125 is changed, the host will not recognize the response because the controller already transmits it with the new baud rate.

### Next steps for 82XX / 8200 vector

1. It is now possible to communicate with every controller, i.e. all code numbers can be read and all writeable codes, except C046 (frequency setpoint) and C0135 (control word) can also be changed.  
If the code numbers C0046 and C0135 are to be preselected as well, set C0001 = 3.
2. If the controller is switched on while the operating mode C0001 = 3 is active and the speed setpoint is set to =0, QSP (quick stop) is active. Thus, the drive cannot start in an uncontrolled way. The QSP function can be deactivated by setting bit3 from C0135 to 0.

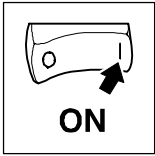

## Commissioning

### Next steps for 93XX

1. Now you can communicate with each drive, i.e. you can read all codes and change all writeable codes.
2. Set the Lenze parameter signal configuration (C0005) to a value xxx1 to control the controller. For the first commissioning, select the signal configuration 1011 (speed control).
3. Terminal 28 (ctrl. enable=controller enable) is always active and must be on HIGH level during operation (see Operating Instructions 93XX). Otherwise, the controller cannot be enabled.
  - With the signal configuration C0005=1011, the QSP function (quick stop) and the CW/CCW changeover are assigned to the input terminals E1 and E2, and thus they are always active. During operation, E1 must be at HIGH level (see Operating Instructions 93XX).



---

### Tip!

With the signal configuration C0005=xx11, terminal A1 is switched as voltage output. Thus, only the following terminals can be connected via cables:

- X5.A1 with X5.28 (ctrl. enable)
  - X5.A1 with X5.E1 (R/QSP)
- 

4. With signal configuration 1011 (speed control), the speed setpoint can be selected in % of  $n_{\max}$  under C0141.



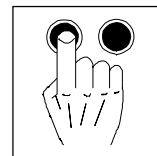

## 6 Parameter setting

The parameter setting for the 2102 fieldbus module comprises:

- Controller parameters which can also be set with the operating units 8201BB or 9371BB.
- 2102 parameters, which can only be accessed via the 2102 fieldbus module.

Only the controller parameters are permanently saved in the corresponding controller.

Only the parameters important for the serial communication are listed in the following and in the code table (see chapter 8.2). For further information about the parameter setting see the Manual or the Operating Instructions of the controllers.

### 6.1 Parameter sets

#### 6.1.1 82XX parameter sets

The 82XX controller is equipped with 2 directly addressable parameter sets. They are addressed by means of a code-digit offset:

- Offset 0 addresses parameter set 1 with the codes C0000 to C1999.
- Offset 2000 addresses parameter set 2 with the codes C2000 to C3999.

If a parameter is only available once (see Operating Instructions 82XX), use the code-digit offset 0.

Example:

C011 = maximum field frequency

C011 in parameter set 1: code number = 11

C011 in parameter set 2: code number = 2011

Changes of the parameters are automatically saved in the controller (see Operating Instructions 82XX). Process data, for instance control words or setpoints are excluded.

#### 6.1.2 Parameter sets for 8200 vector

The 8200 vector controllers are equipped with 4 directly addressable parameter sets. They are addressed by means of a code-digit offset:

- Offset 0 addresses parameter set 1 with the codes C0000 to C1999.
- Offset 2000 addresses parameter set 2 with the codes C2000 to C3999.
- Offset 4000 addresses parameter set 1 with the codes C4000 to C5999.
- Offset 6000 addresses parameter set 2 with the codes C6000 to C7999.

If a parameter is only available once (see 8200 vector Operating Instructions), use code offset 0.

Example:

C011 = maximum field frequency

C011 in parameter set 1: code number = 11

C011 in parameter set 2: code number = 2011

C011 in parameter set 3; code number = 4011

C011 in parameter set 4; code number = 6011

Changes of the parameters are automatically saved in the controller (see Operating Instructions 8200 vector). Process data, for instance control words or setpoints are excluded.

#### 6.1.3 Parameter sets for 93XX

The 93XX controllers are equipped with 4 parameter sets for non-volatile storage. Another parameter set is in the user memory of the controller. This is the current parameter set. Only the current parameter set can be directly addressed. Codes: See Operating Instructions or Manual 93XX. Changes of the current parameter set will be lost after switching off the controller. Code C0003 is for saving the current parameter set. After switching on the controller, parameter set 1 is automatically loaded into the current parameter set.

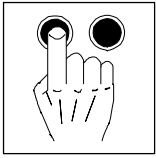

## Parameter setting

### 6.2 Meaning of individual parameters

#### 6.2.1 Operating mode

##### 82XX / 8200 vector controllers

Code C0001 (operating mode) determines the source (terminal, keypad, LECOM) which writes the frequency setpoint (C0046) and the control word (C0135).

Independently of the selected operating mode C0001, the controller can be inhibited under C0040 via LECOM.



#### Tip!

Please note that the operating mode C0001 is available in both parameter sets. Thus, C0001 must be set identically in both parameter sets.

For LECOM control (C0001 = 3), the operating mode in parameter set 1 applies. For terminal control (C0001 <> 3), the operating mode in parameter set 1 and parameter set 2 applies.

##### 93XX controllers

The 93XX controller does not offer an operating mode which can be changed by only one code - as available in the 82XX controller. The 93XX controller is operated via the so-called "Control codes". If, for instance, the speed setpoint is to be changed via LECOM, it is necessary to define a control code as source for the speed setpoint input of the speed controller. Select the configuration of the control code so that you can enter the speed setpoint via the 2102 fieldbus module. For further information please refer to the Manual 93XX.

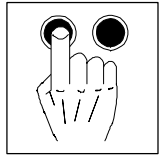

## 6.2.2 LECOM unit address (C0009)

The LECOM-A/B protocol uses the LECOM unit address to address the controller. The LECOM unit address is set under code C0009 at the controller. The address must only be used **once**. Thus, each controller must get its own LECOM unit address. The values 00, 10, 20, 30, ..., 90 must not be set since they are reserved for group addressing (see chapter 5).

The LECOM-A/B protocol enables controller groups. This allows a write request to be issued to several drives at the same time, e.g. to select new setpoints or enable or inhibit the controller. Select via the following reserved LECOM unit addresses:

LECOM unit address C0009 for group drives	LECOM unit addresses of the addresses controllers
00	all
10	11 to 19
20	21 to 29
30	31 to 39
40	41 to 49
50	51 to 59
60	61 to 69
70	71 to 79
80	81 to 89
90	91 to 99



### Tip!

Please note that with LECOM controller addresses which end with a 0, the controller does not return an acknowledgement, i.e. the host does not recognize whether the controller received the data correctly or not.

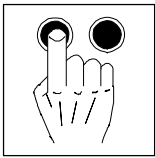

## Parameter setting

### 6.3 Special features when using the 82XX controller



#### Tip!

Reading and writing of the parameter C192x of 82XX controllers takes up to 500 ms.

#### 6.3.1 Start with Ctrl. inhibit instead of QSP

- After mains connection with the operating mode C0001 = 3, the drive is in the status QSP.
- With C1920 = 1, the switch-on status is always Ctrl. inhibit, so that the drive can be enabled by writing C0040 = 1.

Code	Name	Note
C1920	Start status (P2102)	<b>0</b> QSP <b>1</b> Controller inhibit  LECOM format: VD

#### 6.3.2 Reduction of the response time of the interface

- With active reduced response time, write telegrams (send) are only checked for transmission errors:
  - If the telegram is fault-free, a positive acknowledgement (ACK) is sent, otherwise it is a negative acknowledgement (NAK).
  - Only then the value to be written is transmitted to the controller.
- The module can be readdressed under the following conditions:
  - With 820X controllers after approx. 230 ms.
  - With 821X/8200vector/822X controllers after approx. 50 ms.



#### Stop!

The acceptance of the value by the controller cannot be guaranteed.

Code	Name	Note
C1921	Shortened response time (P2102)	<b>0</b> Not active <b>1</b> active  LECOM format: VD

#### 6.3.3 Communication monitoring

- The fieldbus module can monitor the communication connection to the host.
- If the host does not send a telegram to the fieldbus module within the monitoring time set under C1923, the measure set under C1922 will be carried out.

Code	Name	Note
C1922	Monitoring selection code (P2102)	<b>0</b> Not active <b>1</b> Controller inhibit <b>2</b> QSP (quick stop)  LECOM format: VD
C1923	Monitoring time (P2102)	50 to 65535ms  LECOM format: VD

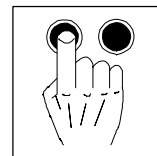

## 6.4 Special features when using the 820X controllers

- Parameter setting (codes except C0046, C0135) is only possible while the controller is inhibited. Parameters are accepted during controller enable but not saved.
- The TRIP reset function (fault reset) is executed by setting controller inhibit followed by controller enable via code C0040 or C0135.
  - The TRIP-reset function performs basic initialization of the 820X controller and the 2102 fieldbus module. Therefore, the TRIP reset command is not acknowledged to the host, thus causing its telegram monitoring to react.

### 6.4.1 Relative setpoint selection C0141 (parameter channel)

- Enter a relative setpoint, which refers to C0011, under C0141.
- Independently of the currently set parameter, C0011 of parameter set 1 is always taken as reference value.
- The automatic adaption of the relative setpoint in the event of a C0011 change is not considered because C0011 can only be changed when the controller is inhibited.

Code	Name	Note
C0141	Frequency setpoint (P2102)	0 to 100 % LECOM format: VD

### 6.4.2 Special features when using the 820X V1.2 controller

Code	Name	Note
C0120		Code not available
C0181	Window for hysteresis output $f_{dact} = f_{dset}$ (P2102)	0 to 80 % LECOM format: VD

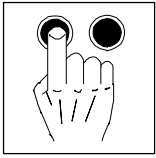

## Parameter setting

### 6.5 Special notes for 821X, 822X, 824X controllers

#### Relative setpoint selection C0127 (process and parameter channel)

- Absolute setpoint selection  
A setpoint is input as absolute Hz value via the process and the parameter channel:

Process channel:	Setpoint absolute $\pm 24000 \triangle 480$ Hz
Parameter channel:	C046 absolute in Hz C141 no influence

- Normalized setpoint selection  
A setpoint is input as absolute C0011 value via the process and parameter channel:

Process channel:	Setpoint absolute $\pm 2^{14} \triangle C011 (fd_{max})$
Parameter channel:	C046 only display absolute in Hz C141 $\pm 100.00\% \triangle C011 (fd_{max})$

Code	Name	Note
C0127	Frequency setpoint selection format (P2102)	0 <b>Absolute setpoint selection</b> 1 Normalized setpoint selection LECOM format: VD

### 6.6 Special notes when using 8200 vector controllers

The digital and analog input and output signals can be configured freely (see Operating Instructions vector; codes C0410, C0412, C0417 and C0421).



## 7 Troubleshooting and fault elimination

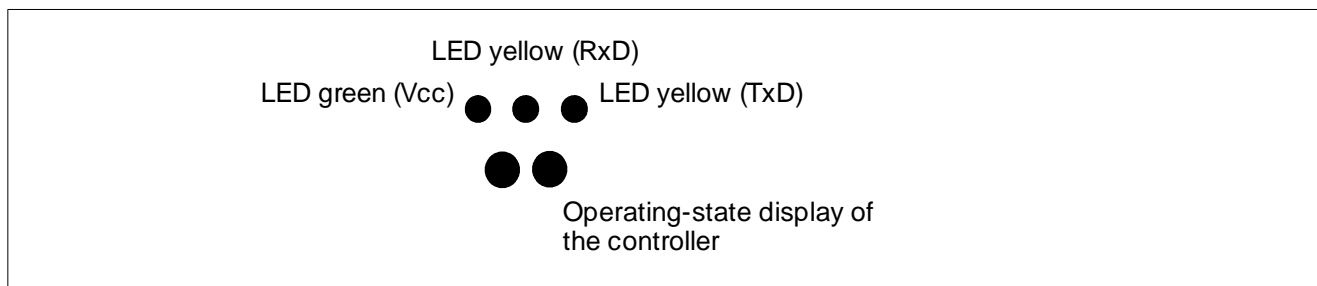

Fig. 7-1 LEDs on the fieldbus module 21021B (see Fig. 4-2 page (4-2) )

Fault	Cause	Remedy
No communication with the controller.	Controller is switched off. Display: <ul style="list-style-type: none"> <li>• none of the operating-state displays is lit-up and/or</li> <li>• green Vcc-LED is blinking</li> </ul>	Supply controller with voltage (see corresponding Operating Instructions)
	21021B fieldbus module is not supplied with voltage Display: green Vcc-LED is not flashing or blinking.	<ul style="list-style-type: none"> <li>• With internal supply from the controller, check the connection to the controller.</li> <li>• With external supply, check the voltage at terminals 39 and 59. A voltage between 15 and 30 V must be applied (see chapter 4.3)</li> </ul>
	The 21021B fieldbus module has not been initialized with the controller Display: green Vcc-LED is blinking.	<ul style="list-style-type: none"> <li>• Supply controller with voltage (see corresponding Operating Instructions)</li> <li>• Check the connection to the controller.</li> </ul>
	The controller does not receive telegrams. For a test, let the host send telegram cyclically. This happens, for instance, with LEMOC2 in online operation. The yellow RxD-LED must blink when the host sends a telegram.	If the yellow RxD-LED does not blink: <ul style="list-style-type: none"> <li>• Check the wiring (see chapter 4.4)</li> </ul> and <ul style="list-style-type: none"> <li>• Test whether the host sends telegrams and uses the appropriate interface.</li> </ul>
	The controller does not send telegrams. For a test, let the host send telegram cyclically. This happens, for instance, with LEMOC2 in online operation. The yellow TxD-LED must blink when the controller send a telegram to the host.	1. Yellow TxD-LED is not blinking: Parameter for LECOM unit address (C0009) and LECOM baud rate (C0125) must be the same at the controller and the host. Check the parameters C0009 and C0125 at both units and set them to the same value if necessary. (Controller-address parameters 00, 10, ..., 90 must not be used.)  2. Yellow TxD-LED is blinking: <ul style="list-style-type: none"> <li>• The LECOM unit addresses (C0009) must be different at all connected controllers. Correct possibly occurring double addressing.</li> <li>• Check the wiring to your host.</li> <li>• With self-developed LECOM-A/B software drivers and RS485 operation, observe the transmission control. After transmitting signals, the host must return to receive mode after approx. 1 ms.</li> </ul>
Controller does not execute write job	1. Controller sends negative acknowledgement (NAK response): <ul style="list-style-type: none"> <li>• The operating mode C0001 is set incorrectly for write access to codes C0046 and C0135.</li> <li>• The code is defined so that it can only be read.</li> </ul>	<ul style="list-style-type: none"> <li>• Set parameter 3 for operating mode C0001.</li> <li>• In general, write job not possible.</li> </ul>
	2. Controller sends positive acknowledgement (ACK response): <ul style="list-style-type: none"> <li>• With 820X, parameters can only be changed when the controller is inhibited (see chapter 6.3).</li> <li>• Controller uses a different parameter set</li> </ul>	<ul style="list-style-type: none"> <li>• Activate controller inhibit</li> <li>• Changeover of the parameter set; the parameter change is then activated.</li> </ul>



## ***Troubleshooting and fault elimination***



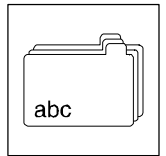

## 8 Appendix

### 8.1 Accessories

#### 8.1.1 Accessories for a host

In the following you will find the accessory components for hosts (PC or PLC):

Name	Order no.	Explanation
LEMOC2	EW00388233	PC program for drive programming; System requirements: IBM AT compatible
Operating Instructions LECOM-S5	33.2164	Communication processor for Siemens-SIMATIC-S5 AG 115U, 135U, 150U, 155U
LECOM-PC	-	LECOM-A/B communication driver for PC systems in C/C++ (source code). A modification for other target systems can be easily achieved.
LECOM-PN	-	Driver for PC the visualisation system PROCON produced by gti
B&R Mitsubishi Schleicher Sigmatek Cotas AMS	-	Drivers for various PLC systems. Further information on request.

#### 8.1.2 Accessories for RS232 (LECOM-A)

In the following you will find the accessory components for RS232 (LECOM-A):

Name	Order no.	Explanation
PC system cable 5 m	EW00338094	between fieldbus module 2102IB and PC (9pole socket)
PC system cable 10 m	EW00338095	between fieldbus module 2102IB and PC (9pole socket)

Specification for RS232 interface cables	
Cable type	LIYCY 4 x 0.25 mm <sup>2</sup> shielded
Cable resistance	< 100 Ω/km
Capacitance per unit length	< 140 nF/km
Length	≤ 15 m

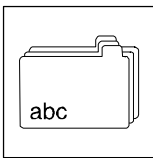

## Appendix

### 8.1.3 Accessories for RS485 (LECOM-B)

In the following you will find the accessory components for RS485 (LECOM-B):

Name	Order no.	Explanation
Interface converter 2101IB	33.2101IB	Level converter between RS232 and RS485/RS422 with electrical isolation
PC system cable 5 m	EW00338094	System cable between PC (9-pole female connector) and 2101IB interface converter

Specification for RS485-interface cable	
with a length of up to 300 m:	
Cable type	LIYCY 1 x 2 x 0.5 mm <sup>2</sup> shielded
Cable resistance	≤ 40 Ω/km
Capacitance per unit length	≤ 130 nF/km
Length	≤ 300 m
with a length of up to 1200 m:	
Cable type	CYPIMF 1 x 2 x 0.5 mm <sup>2</sup> shielded
Cable resistance	≤ 40 Ω/km
Capacitance per unit length	≤ 60 nF/km
Length	≤ 1200 m

### 8.1.4 Accessories for optical fibres (LECOM-LI)

In the following you will find the accessory components for optical fibres (LECOM-LI):

Name	Order no.	Explanation
2125	33.2125IB	Optical fibre/RS232 converter for hosts normal transmission rate (0 to 40m)
2126	33.2126IB	Optical fibre/RS232 converter for hosts high transmission rate (10 to 66m)
Plug-in power supply unit	EJ0362016	Plug-in power supply unit 220V/9V DC for 2125 and 2126
Operating Instructions LECOM-LI	EDLECOM-LI/D	Basics and installation of LECOM-LI
Optical fibre 1ADR with PE sheath	EW00359679 (by the meter)	Optical-fibre cable with black PE sheath (standard protection)
Optical fibre 1ADR with PUR sheath	EW00359681 (by the meter)	Optical-fibre cable with red PUR sheath (reinforced protection)

Specification for optical fibre cables	
Field	Values
Min. bending radius	30 mm
Max. tensile force	100 N
Electric strength	110 kV/m
Operating temperature	- 40 to +80 °C
Wave length	660 nm
Damping	100 to 400 dB/km
Cable length between two participants (cable damping = 150dB/km)	0 to 40 m (normal transmission rate) 10 to 66 m (high transmission rate)
Fibre core Material/diameter	Polymethylmethacrylat (PMMA) / 976 µm
Fibre sheath Material/diameter	Fluoropolymer / 1000 µm
Outer sheath Material/diameter	Thermoplast polyester (PE) / 2.2 mm

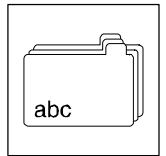

## 8.2 Code table

How to read the code table:

<b>Code</b>	Code number of the parameter	Leading zeros are not required. Codes marked with * are only available in parameter set 1.
<b>Name</b>	Name of the parameter	The text in parenthesis informs whether the codes are available in the fieldbus module or the controller:
		(P2102): Parameters in the fieldbus module 2102IB
		(P820X/P821X/8200 vector/822X): Parameters in controllers 820X, 821X and 822X. The parameters can also be set via the 8201BB keypad.
		(P93XX):Parameters in the 93XX controller. The parameters can also be set via the 9371BB keypad.
<b>Parameters</b>	Contents and meaning of the parameter values	Parameters printed in bold are set by Lenze.

Code	Name	Note	
C0001	Operating mode for  • 82XX • 8200 vector  (P82XX)	<b>82XX</b>	<b>8200 vector</b>
		<b>0</b> <b>Control (C0135): Terminal</b> <b>Setpoint (C0046): Terminal</b> (Lenze setting: 0) 1    Control (C0135): Terminal Setpoint (C0046):    Keypad: 2    Control (C0135): Terminal Setpoint (C0046):    Terminal 3    Control (C0135): LECOM Setpoint (C0046):    LECOM  The operating mode defines the source which writes on a parameter. The keypad and LECOM always have the right to parameterize.  LECOM format: VD	see Operating Instructions 'Vector'
C0009*	LECOM controller address  (P82XX) (P93XX)	<b>1</b> 1 to 99 Controller address for unique address in a LECOM-A/B/LI network. Do not set the values 00, 10, ..., 90, since they are reserved for group addressing.  LECOM format: VD	
C0040*	Controller inhibit  (P2102)	0    Controller inhibited 1    Controller enabled Parameter C0040 is independent of operating mode C0001. The controller can also be enable with control word C0135.  LECOM format: VD	
C0043*	TRIP reset for: • 821X • 8200 vector • 822X • 93XX  (P2102)	0    No actual fault, fault reset by overwriting with value 0 1    Actual fault Parameter C0043 is independent of operating mode C0001. A TRIP can also be reset using the control word C0135. (TRIP reset for 820X, see chapter 6.4)  LECOM format: VD	
C0046*	Frequency setpoint for: • 820X  (P2102)	0 to 480 Hz  LECOM format: VD	
	Frequency setpoint for: • 821X • 8200 vector • 822X  (P821X/P8200 vector/P822X)  Speed setpoint for 93XX (C0046 can only be read.)	0 to 480 Hz The value can be changed through the display factor C500/C501 (see Code table included in the Operating Instructions 820X, 821X and 822X).  For 93XX, the free control code C0141 is used as speed setpoint in % of $n_{max}$ if the basic configuration is C0005=1001.  LECOM format: VD	

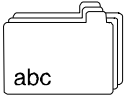

# Appendix

Code	Name	Note			
		Bit	82XX	8200 vector	93XX
C0068*	Operating status for: • 82XX • 8200 vector • 93XX  (P2102)	0 - 3	Operating fault (TRIP) The 10th digit of the LECOM fault number (see C0161 to C0164) is displayed. Example: TRIP OH = 5 (LECOM no. = 50)		
		4 - 7	Last communication error 0 = No fault 1 = Check sum error 2 = Protocol frame error 3 = Reserved 4 = Invalid code number 5 = Invalid variable 6 = No access permission 7 = Telegram processing interrupted by a new telegram 15 = General fault		
		8	Ctrl. enable 0 = no controller enable 1 = Controller enable		
		9	$Q_{min} (f_d \leq f_{dQmin})$ 0 = $Q_{min}$ not active 1 = $Q_{min}$ active	FREE; fig C0150.Bit 5 Default setting: $Q_{min} (f_d \leq f_{dQmin})$ 0 = $Q_{min}$ not active 1 = $Q_{min}$ active	
		10	Direction of rotation 0 = CW rotation 1 = CCW rotation	Reserved	
		11	IMP (pulse inhibit) 0 = Pulses to power stages inhibited 1 = Pulses for power stages enabled	FREE; display of C0150 bit 1 Default setting: IMP (Pulse inhibit) 0 = Pulses to power stages inhibited 1 = Pulses for power stages enabled	
		12	QSP (quick stop) 0 = QSP not active 1 = QSP active	Reserved	
		13	$I_{max}$ (current limit reached) 0 = Current limit not reached 1 = Current limit reached	FREE; display of C0150 bit 2 Default setting: $I_{max}$ (Current limit reached) 0 = Current limit not reached 1 = Current limit reached	
		14	$f_d = f_{dset}$ (Act. frequency = Frequency setpoint) 0 = $f_d >> f_{dset}$ 1 = $f_d = f_{dset}$	FREE; display of C0150 bit 4 RFG on = RFG off (Ramp-function generator input = ramp-function generator output) 0 = HLG on <> HLG off 1 = RFG on = RFG off	
		15	TRIP (fault) 0 = No error 1 = Fault occurred		
LECOM format: VH					
C0125*	LECOM baud rate  (P82XX) (P93XX)	<b>0</b> <b>9600 Baud</b> (Factory setting) <b>1</b> 4800 Baud <b>2</b> 2400 Baud <b>3</b> 1200 Baud <b>4</b> 19200 Baud	Transmission rate for LECOM-A/B/LI in bit/s (= baud).  LECOM format: VD		
C0127	Selection Setpoint selection  (P821X, P822X, P824X) (P2102)	<b>0</b> <b>Absolute setpoint selection</b> <b>1</b> Normalized setpoint selection	LECOM format: VD		

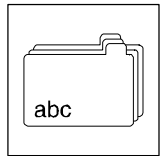

Code	Name	Note		
		Bit	820X	821X, 8200 vector, 822X
C0135*	Controller control word (parameter channel) for: <ul style="list-style-type: none"> <li>• 820X</li> <li>• 821X</li> <li>• 8200 vector</li> <li>• 822X</li> </ul> (P2102)	0	JOG1, JOG2, JOG3 0 = C0046 active 1 = JOG1 (C0037) active	
		1	2 = JOG2 (C0038) active 3 = JOG3 (C0039) active JOG1, JOG2, JOG3	
		2	CW/CCW (CW rotation/CCW rotation) 0 = CW rotation 1 = CCW rotation	
		3	QSP (quick stop) 0 = QSP not active 1 = QSP active	
		4	Reserved	RFG stop (stop of the ramp function generator) 0 = RFG stop not active 1 = RFG stop active
		5	Reserved	RFG zero (deceleration along the T <sub>if</sub> ramp C0013) 0 = RFG zero not active 1 = RFG zero active
		6	Reserved	UP function for motor potentiometer 0 = UP not active 1 = UP active
		7	Reserved	DOWN function for motor potentiometer 0 = DOWN not active 1 = DOWN active
		8	Reserved	
		9	Ctrl. inhibit (controller inhibit) 0 = No controller inhibit 1 = Controller inhibit	
		10	Reserved	
		11	Reserved	TRIP reset 0⇒1 Edge from 0 to 1 causes TRIP reset
		12	PAR (parameter set changeover) 0 ⇒ 1 (= parameter set 2) 1 ⇒ 0 (= parameter set 1)	
		13	Reserved	
		14	DC brake (DC injection brake) 0 = DCB not active 1 = DCB active	
		15	Reserved	
	The control word controls the controller. It compresses and summarizes control commands in bit commands. LECOM format: VH			

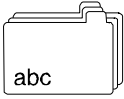

# Appendix

Code	Name	Note			
		Bit	General structure	1xx1 Speed control	4xx1 Torque control
C0135*	Controller control word (parameter channel) for: <ul style="list-style-type: none"> <li>93XX general</li> <li>93XX default setting for               <ul style="list-style-type: none"> <li>- C0005 = 1xx1</li> <li>- C0005 = 4xx1</li> </ul> </li> </ul> (P2102)	0	FREE 0 (free access)	JOG1, JOG2, JOG3 0 = C0141 (speed setpoint in % of $n_{max}$ ) active	FREE 0 (free access)
		1	FREE 1 (free access)	1 = JOG1 (C0039.1) active 2 = JOG2 (C0039.2) active 3 = JOG3 (C0039.3) active	FREE 1 (free access)
		2	FREE 2 (free access)		
		3	QSP (quick stop) 0 = QSP not active 1 = QSP active		
		4	(free access)	NSET-RFG-STOP (stop of the ramp function generator) 0 = NSET-RFG-STOP not active 1 = NSET-RFG-STOP active	
		5	(free access)	NSET-FRG-0 (deceleration at the Tif ramp C0013) 0 = NSET-RFG-0 not active 1 = NSET-RFG-0 active	
		6	FREE 6 (free access)		
		7	FREE 7 (free access)		
		8	Reserved		
		9	Ctrl. inhibit (controller inhibit) 0 = No controller inhibit 1 = Controller inhibit		
		10	Reserved		
		11	TRIP reset 0⇒1 Edge from 0 to 1 causes TRIP reset		
		12	(free access)	PAR*1 (parameter set changeover) 0 = PS 2/4 1 = PS 1/3)	
		13	(free access)	PAR-SET Activate parameter set changeover	
		14	(free access)	$T_{i1}, T_{i2}, T_{i3}$ 0 = C0012/C0013 active 1 = $T_{i1}$ , (C0102.1/C0103.1) active 2 = $T_{i2}$ , (C0102.1/C0103.1) active 3 = $T_{i3}$ , (C0102.1/C0103.1) active	JOG1, JOG2, JOG3 0 = No active JOG 1 = JOG1 (C0039.1) active 2 = JOG2 (C0039.2) active 3 = JOG3 (C0039.3) active
		15	(free access)		
The control word controls the controller. It includes the control commands in a compressed bit format. LECOM format: VH					

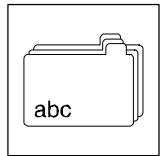

Code	Name	Note			
		Bit	5xx1 Digital frequency master	6xx1 LF slave bus	7xx1 LF slave cascade
C0135*	Controller control word (parameter channel) for:  • 93XX default setting for – C0005 = 5xx1 – C0005 = 6xx1 – C0005 = 7xx1  (P2102)	0	JOG1, JOG2, JOG3 0 = C0141 (speed setpoint in % of $n_{max}$ ) active	FREE 0 (free access)	
		1	1 = JOG1 (C0039.1) active 2 = JOG2 (C0039.2) active 3 = JOG3 (C0039.3) active	FREE 1 (free access)	
		2	FREE 2 (free access)		
		3	QSP (quick stop) 0 = QSP not active 1 = QSP active		
		4	NSET-RFG-STOP (stop of the ramp function generator) 0 = NSET-RFG-STOP not active 1 = NSET-RFG-STOP active		
		5	NSET-FRG-0 (deceleration at the Tif ramp C0013) 0 = NSET-FRG-0 not active 1 = NSET-FRG-0 active		
		6	FREE 6 (free access)		
		7	FREE 7 (free access)		
		8	Reserved		
		9	Ctrl. inhibit (controller inhibit) 0 = No controller inhibit 1 = Controller inhibit		
		10	Reserved		
		11	TRIP reset 0⇒1 Edge from 0 to 1 causes TRIP reset		
		12	PAR*1 (parameter set changeover) 0 = PS 2/4 1 = PS 1/3)		
		13	PAR-SET Activate parameter set changeover		
		14	REF-ON Start homing function		
		15	$T_{i1}$ 0 = C0012/C0013 active 1 = $T_{i1}$ (C0102.1/C0103.1) active	FREE 15 (free access)	
The control word controls the controller. It includes the control commands in a compressed bit format. LECOM format: VH					
C0141	Setpoint Appropriately selected Configuration	<b>Signal configuration</b>	<b>Signal</b>	<b>Meaning</b>	
		1x1 (Speed control)	NSET-N	Speed setpoint in % of $n_{max}$	
		4xx1 (Torque control)	MCTRL-M-ADD	Torque setpoint in %	
		5xx1 (Master frequency)	NSET-N	Speed setpoint in % of $n_{max}$	
		6xx1 (Master frequency - slave bus)	NSET-N	Speed setpoint in % of $n_{max}$	
		7xx1 (Master frequency - slave cascade)	NSET-N	Speed setpoint in % of $n_{max}$	

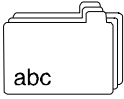

# Appendix

Code	Name	Note				
		Bit	820X	821X, 822X	8200 vector	
C0150*	Controller status word (parameter channel) for:  <ul style="list-style-type: none"> <li>• 820X</li> <li>• 821X</li> <li>• 8200 vector</li> <li>• 822X</li> </ul> (P2102)				<b>Free configuration via C0417</b> (see Operating Instructions for 8200 vector)	
		0	Reserved	Actual parameter set 0 = PS 1 active 1 = PS 2 active	FREE 0 (free access)	
		1	IMP (pulse inhibit) 0 = Pulses for power stage enabled 1 = Pulses for power stage inhibited			
		2	I <sub>max</sub> (current limit reached) 0 = Current limit not reached 1 = Current limit reached			FREE 2 (free access)
		3	Reserved	f <sub>d</sub> = f <sub>dset</sub> (Act. frequency = Frequency setpoint) 0 = f <sub>d</sub> <> f <sub>dset</sub> 1 = f <sub>d</sub> = f <sub>dset</sub>	FREE 3 (free access)	
		4	f <sub>d</sub> = f <sub>dset</sub> (Act. frequency = Frequency setpoint) 0 = f <sub>d</sub> <> f <sub>dset</sub> 1 = f <sub>d</sub> = f <sub>dset</sub>	RFG on = RFG off (RFG input = RFG output) 0 = RFG in < > RFG out 1 = RFG on = RFG off	FREE 4 (free access)	
		5	Q <sub>min</sub> (f <sub>d</sub> ≤ f <sub>dQmin</sub> ) 0 = Q <sub>min</sub> not active 1 = Q <sub>min</sub> active			FREE 5 (free access)
		6	f <sub>d</sub> = 0 (act. frequency = 0) 0 = f <sub>d</sub> < > 0 1 = f <sub>d</sub> = 0			
		7	Ctrl. inhibit (controller inhibit) 0 = No controller inhibit 1 = Controller inhibit			
		8 - 11	Controller status 0 = No error 1 = Error	Controller status 0 = Unit initialisation 1 = Autostart lock 3 = Operation inhibited 4 = Flying-restart circuit active 5 = DC injection braking active 6 = Operation enable 7 = Message active (dynamically set pulse inhibit, e.g. at OU) 8 = Fault active	Controller status 0 = Unit initialisation 1 = Autostart lock 3 = Operation inhibited 6 = Operation enable 7 = Message active (dynamically set pulse inhibit, e.g. at OU) 8 = Fault active 9 = Power off	
		12	Overtemperature warning (ϑ <sub>max</sub> - 10 °C) 0 = No controller inhibit 1 = Controller inhibit			Warning 0 = No warning 1 = Warning
		13	U <sub>Gmax</sub> (DC-bus overvoltage) 0 = No overvoltage 1 = Overvoltage			Message 0 = No message 1 = Message
		14	Direction of rotation 0 = CW rotation 1 = CCW rotation			FREE 14 (free access)
		15	Ready for operation (no error, overvoltage or undervoltage) 0 = Not ready for operation 1 = Ready for operation			FREE 15 (free access)
		The status word contains the most important status information in a compressed form. LECOM format: VH				



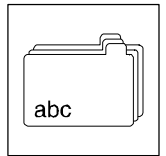

Code	Name	Note			
		Bit	General structure	1xx1 Speed control 4xx1 Torque control	
C0150*	Controller status word (parameter channel) for:  <ul style="list-style-type: none"> <li>• 93XX general</li> <li>• 93XX default setting for               <ul style="list-style-type: none"> <li>– C0005 = 1xx1</li> <li>– C0005 = 4xx1</li> </ul> </li> </ul> (P2102)	0	(free access)	Actual parameter set 0 = PS 2/4 active 1 = PS 1/3 active	
		1	IMP (pulse inhibit) 0 = Pulses for power stage enabled 1 = Pulses for power stage inhibited		
		2	(free access)	$I_{max}$ (current limit reached) 0 = Current limit not reached 1 = Current limit reached	
		3	FREE 3 (free access)		
		4	(free access)	RFG on = RFG off (RFG input = RFG output) 0 = RFG in < > RFG out 1 = RFG on = RFG off	
		5	(free access)	$Q_{min}$ ( $f_d \leq f_{dQmin}$ ) 0 = $Q_{min}$ not active 1 = $Q_{min}$ active	
		6	$f_d = 0$ (act. frequency = 0) 0 = $f_d < > 0$ 1 = $f_d = 0$	$n = 0$ (actual speed value = 0) 0 = $n < > 0$ 1 = $n = 0$	
		7	Ctrl. inhibit (controller inhibit) 0 = No controller inhibit 1 = Controller inhibit		
		8 - 11	Controller status 0 = Unit initialisation 1 = Switch-on inhibit 3 = Operation inhibited 6 = Operation enable 7 = Message active 8 = Active fault 9 = Power off		
		12	Warning 0 = No warning 1 = Warning		
		13	Message 0 = No warning 1 = Warning		
		14	FREE 14 (free access)		
		15	(free access)	Ready for operation (no error, overvoltage or undervoltage) 0 = Not ready for operation 1 = Ready for operation	
		The status word contains the most important status information in compressed form. On the following pages you will find the assignment of the freely combineable bits for the predefined signal configuration of the controller. LECOM format: VH			

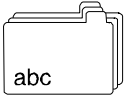

# Appendix

Code	Name	Note				
		Bit	5xx1 Digital frequency master	6xx1 LF slave bus	7xx1 LF slave cascade	
C0150*	Controller status word (parameter channel) for:  • 93XX default setting for – C0005 = 5xx1 – C0005 = 6xx1 – C0005 = 7xx1  (P2102)	0	Actual parameter set 0 = PS 2/4 active 1 = PS 1/3 active			
		1	IMP (pulse inhibit) 0 = Pulses for power stage enabled 1 = Pulses for power stage inhibited			
		2	REF-OK 0 = Homing function not ok 1 = Homing function ok			
		3	$M_{max}$ (torque limit reached) 0 = torque limit not reached 1 = torque limit reached	NOT1-OUT 0 = torque limit reached 1 = torque limit not reached		
		4	RFG on = RFG off (RFG input = RFG output) 0 = RFG in < > RFG out 1 = RFG on = RFG off			
		5	REF-BUSY 0 = Homing function not active 1 = Homing function active			
		6	$n = 0$ (actual speed value = 0) 0 = $n < > 0$ 1 = $n = 0$			
		7	Ctrl. inhibit (controller inhibit) 0 = No controller inhibit 1 = Controller inhibit			
		8 - 11	Controller status 0 = Unit initialisation 1 = Switch-on inhibit 3 = Operation inhibited 6 = Operation enable 7 = Message active 8 = Active fault 9 = Power off			
		12	Warning 0 = No warning 1 = Warning			
		13	Message 0 = No warning 1 = Warning			
		14	FREE 14 (free access)			
		15	Ready for operation (no error, overvoltage or undervoltage) 0 = Not ready for operation 1 = Ready for operation			
		The status word contains the most important status information in compressed form. On the following pages you will find the assignment of the freely combineable bits for the predefined signal configuration of the controller. LECOM format: VH				

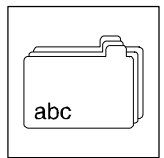

Code	Name	Keypad	PC 1)	Error	Cause	Remedy
C0161* C0162* C0163* C0164*	Fault memory  (P82XX)	---	0	No error	-	-
		CCr	71	System error	Strong interference on control cables Ground or earth loops in the wiring	Shield control cables
		CE0	61	Communication error to AIF	Faulty transmission of control commands via AIF	Insert the communication module into the hand terminal
		CE1	62	Communication error to CAN-IN1 with sync control	CAN-IN1-object receives faulty data or communication is interrupted	Plug-in connection - bus module ⇔ Check FIF Check transmitter Increase monitoring time under C0357/1 if necessary
		CE2	63	Communication error to CAN-IN2	CAN-IN2-object receives faulty data or communication is interrupted	Plug-in connection - bus module ⇔ Check FIF Check transmitter Increase monitoring time under C0357/2 if necessary
		CE3	64	Communication error to CAN-IN1 with event or time control	CAN-IN1-object receives faulty data or communication is interrupted	Plug-in connection - bus module ⇔ Check FIF Check transmitter Increase monitoring time under C0357/3 if necessary
		CE4	65	BUS-OFF (many communication errors occurred)	Controller has received too many incorrect telegrams via the system bus and has been disconnected	Check whether bus terminator available Shield control of the cables Check PE connection Check bus load, if necessary, reduce the baud rate
		CE5	66	CAN Time-Out	For remote parameter setting via system bus (C0370): Slave does not answer. Communication monitoring time exceeded.	Check system bus wiring Check system bus configuration
					For operation with module in FIF: Internal fault	Contact Lenze
		EEr	91	External fault (TRIP-Set)	A digital signal assigned to TRIP set has been activated	Check external encoder
		HD5	105	Internal fault		Contact Lenze
		Id1	140	Faulty parameter identification	Motor not connected	Connect motor
		LP1	32	Fault in motor phase (TRIP)	Failure of one/several motor phase(s)	Check motor cables, check $V_{min}$ boost, connect the motor with the corresponding power or adapt it under C0599.
					Motor current too low	
		LU	103 0	DC-bus undervoltage (only message without TRIP)	Mains voltage too low	Check mains voltage
					DC-bus voltage too low	Check supply cable
		DC1	11	short-circuit	short-circuit	Find reason for short-circuit; check motor cable
					Excessive capacitive charging current of the motor cable	Use shorter motor cables with lower charging current
		DC2	12	Earth fault	Grounded motor phase	Check motor, check motor cable
					Excessive capacitive charging current of the motor cable	Use shorter motor cables with lower charging current
DC3	13	Overload inverter during acceleration or short circuit	Acceleration time too short (C0012)	<ul style="list-style-type: none"> <li>Increase acceleration time</li> <li>Check drive dimensioning</li> </ul>		
			Defective motor cable	Check wiring		
			Interturn fault in the motor	Check motor		
DC4	14	Overload controller during deceleration	Deceleration time set too short (C0013)	<ul style="list-style-type: none"> <li>Increase deceleration time</li> <li>Check size of external brake resistor</li> </ul>		
DC5	15	Controller overload in stationary operation	Frequent and long overload	Check drive dimensioning		
DC6	16	Motor overload ( $I^2 \times t$ overload)	Motor is thermally overloaded, for instance, because of <ul style="list-style-type: none"> <li>impermissible continuous current</li> <li>frequent or too long acceleration processes</li> </ul>	<ul style="list-style-type: none"> <li>Check drive dimensioning</li> <li>Check setting of C0120</li> </ul>		

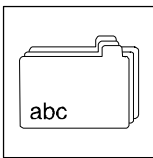

# Appendix

Code	Name	Keypad	PC 1)	Error	Cause	Remedy
		<i>DH</i>	50	Heat sink temperature exceeds the value entered for the controller	Ambient temperature $T_{amb} > +60\text{ °C}$	<ul style="list-style-type: none"> <li>Allow controller to cool and ensure better ventilation</li> <li>Check ambient temperature</li> </ul>
					Heat sink very dirty	Clean heat sink
					Impermissibly high currents or too frequent and too long acceleration	<ul style="list-style-type: none"> <li>Check drive selection</li> <li>Check load, if necessary, replace defective bearings</li> </ul>
		<i>DH3</i>	53	PTC monitoring (TRIP)	Motor too hot because of excessive current, or acceleration is too frequent and too long	Check drive dimensioning
		<i>DHS1</i>	203	PTC monitoring (warning)	PTC not connected	Connect PTC or switch off monitoring
		<i>DU</i>	102 0	DC-bus overvoltage (only message without TRIP)	Mains voltage too high	Check voltage supply
	Braking operation				<ul style="list-style-type: none"> <li>Prolong deceleration times.</li> <li>For operation with brake transistor: <ul style="list-style-type: none"> <li>Check the selection and connection of the brake resistor</li> <li>Increase the deceleration times</li> </ul> </li> </ul>	
	Earth leakage on the motor side				Check motor cable and motor for earth fault (disconnect motor from inverter)	
		<i>Pr</i>	75	Faulty parameter transfer when using the keypad	All parameter sets are defective	It is absolutely necessary to repeat the data transfer or load the Lenze setting before enabling the controller.
		<i>Pr-1</i>	72	Wrong PAR1 transfer when using the keypad.	PAR1 is defective.	
		<i>Pr-2</i>	73	Wrong PAR2 transfer when using the keypad.	PAR2 is defective.	
		<i>Pr-3</i>	77	Wrong PAR3 transfer when using the keypad.	PAR3 is defective	
		<i>Pr-4</i>	78	Wrong PAR4 transfer when using the keypad.	PAR4 is defective	
		<i>PT5</i>	81	Time error during parameter set transfer	Data flow from keypad or PC interrupted, e. g. keypad was disconnected during transmission	
	<i>rST</i>	76	Faulty auto-TRIP reset	More than 8 fault messages in 10 minutes	Depends on the fault message	
	<i>Sd5</i>	85	Open circuit at analog input	Current at analog input $< 4\text{ mA}$	Close circuit at analog input	

1) LECOM fault numbers

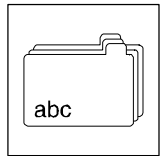

Code	Name	Note																																																																																																																																																								
C0067 C0161 C0168* [1...8]	Fault memory  (P93XX)	<table border="0"> <thead> <tr> <th colspan="2">Fault abbreviations</th> <th colspan="2">LECOM fault numbers</th> </tr> <tr> <th></th> <th>TRIP</th> <th>Warning</th> <th>Message</th> </tr> </thead> <tbody> <tr> <td>---</td> <td>0</td> <td></td> <td></td> </tr> <tr> <td>OC1</td> <td>11</td> <td></td> <td></td> </tr> <tr> <td>OC2</td> <td>12</td> <td></td> <td></td> </tr> <tr> <td>OC5</td> <td>15</td> <td></td> <td></td> </tr> <tr> <td>OU</td> <td></td> <td></td> <td>1020</td> </tr> <tr> <td>LU</td> <td></td> <td></td> <td>1030</td> </tr> <tr> <td>LP1</td> <td>-</td> <td></td> <td></td> </tr> <tr> <td>OH</td> <td>50</td> <td></td> <td></td> </tr> <tr> <td>OH3</td> <td>53</td> <td></td> <td></td> </tr> <tr> <td>OH4</td> <td></td> <td>2054</td> <td></td> </tr> <tr> <td>OH7</td> <td></td> <td>2057</td> <td></td> </tr> <tr> <td>OH8</td> <td>58</td> <td>2058</td> <td></td> </tr> <tr> <td>CE0</td> <td>61</td> <td>2061</td> <td></td> </tr> <tr> <td>CE1</td> <td>62</td> <td>2062</td> <td></td> </tr> <tr> <td>CE2</td> <td>63</td> <td>2063</td> <td></td> </tr> <tr> <td>CE3</td> <td>64</td> <td>2064</td> <td></td> </tr> <tr> <td>U15</td> <td>70</td> <td></td> <td></td> </tr> <tr> <td>CCr</td> <td>71</td> <td></td> <td></td> </tr> <tr> <td>Pr0</td> <td>75</td> <td></td> <td></td> </tr> <tr> <td>Pr1</td> <td>72</td> <td></td> <td></td> </tr> <tr> <td>Pr2</td> <td>73</td> <td></td> <td></td> </tr> <tr> <td>Pr3</td> <td>77</td> <td></td> <td></td> </tr> <tr> <td>Pr4</td> <td>78</td> <td></td> <td></td> </tr> <tr> <td>PEr</td> <td>74</td> <td></td> <td></td> </tr> <tr> <td>PI</td> <td>79</td> <td></td> <td></td> </tr> <tr> <td>Sd2</td> <td>82</td> <td>2082</td> <td></td> </tr> <tr> <td>Sd3</td> <td>83</td> <td>2083</td> <td></td> </tr> <tr> <td>Sd6</td> <td>86</td> <td>2086</td> <td></td> </tr> <tr> <td>EEr</td> <td>91</td> <td>2091</td> <td>1091</td> </tr> <tr> <td>P03</td> <td>153</td> <td>2153</td> <td></td> </tr> <tr> <td>P13</td> <td>163</td> <td></td> <td></td> </tr> <tr> <td>NMAX</td> <td>200</td> <td></td> <td></td> </tr> <tr> <td>H05</td> <td>105</td> <td></td> <td></td> </tr> <tr> <td>H07</td> <td>107</td> <td></td> <td></td> </tr> <tr> <td>H10</td> <td>110</td> <td></td> <td></td> </tr> <tr> <td>H11</td> <td>111</td> <td></td> <td></td> </tr> </tbody> </table> <p>The individual faults are described in the Operating Instructions of the controller. LECOM format: VD</p>	Fault abbreviations		LECOM fault numbers			TRIP	Warning	Message	---	0			OC1	11			OC2	12			OC5	15			OU			1020	LU			1030	LP1	-			OH	50			OH3	53			OH4		2054		OH7		2057		OH8	58	2058		CE0	61	2061		CE1	62	2062		CE2	63	2063		CE3	64	2064		U15	70			CCr	71			Pr0	75			Pr1	72			Pr2	73			Pr3	77			Pr4	78			PEr	74			PI	79			Sd2	82	2082		Sd3	83	2083		Sd6	86	2086		EEr	91	2091	1091	P03	153	2153		P13	163			NMAX	200			H05	105			H07	107			H10	110			H11	111		
Fault abbreviations		LECOM fault numbers																																																																																																																																																								
	TRIP	Warning	Message																																																																																																																																																							
---	0																																																																																																																																																									
OC1	11																																																																																																																																																									
OC2	12																																																																																																																																																									
OC5	15																																																																																																																																																									
OU			1020																																																																																																																																																							
LU			1030																																																																																																																																																							
LP1	-																																																																																																																																																									
OH	50																																																																																																																																																									
OH3	53																																																																																																																																																									
OH4		2054																																																																																																																																																								
OH7		2057																																																																																																																																																								
OH8	58	2058																																																																																																																																																								
CE0	61	2061																																																																																																																																																								
CE1	62	2062																																																																																																																																																								
CE2	63	2063																																																																																																																																																								
CE3	64	2064																																																																																																																																																								
U15	70																																																																																																																																																									
CCr	71																																																																																																																																																									
Pr0	75																																																																																																																																																									
Pr1	72																																																																																																																																																									
Pr2	73																																																																																																																																																									
Pr3	77																																																																																																																																																									
Pr4	78																																																																																																																																																									
PEr	74																																																																																																																																																									
PI	79																																																																																																																																																									
Sd2	82	2082																																																																																																																																																								
Sd3	83	2083																																																																																																																																																								
Sd6	86	2086																																																																																																																																																								
EEr	91	2091	1091																																																																																																																																																							
P03	153	2153																																																																																																																																																								
P13	163																																																																																																																																																									
NMAX	200																																																																																																																																																									
H05	105																																																																																																																																																									
H07	107																																																																																																																																																									
H10	110																																																																																																																																																									
H11	111																																																																																																																																																									
C0248*	LECOM input selection  (P2102)	<p><b>0</b> 0 to 255</p> <p>The parameter LECOM input selection ensures the compatibility with previous master-system drivers according to the LECOM-A/B specification V1.0. This code is only fully used with 93XX, since this series uses the so-called array parameters, i. e. a code consists of several parameters (e.g. C0039 = JOG with 15 values). Code C0248 determines the array element to be accessed. The functionality of the input selection is simulated (before e.g. C0038).</p> <p>This input is valid for all LECOM accesses; i.e. the access of a standard parameter with a LECOM input selection that is not 0 results in a fault because the addressed value does not exist.</p> <p>The array element can be directly addressed via a LECOM-A/B driver as from specification V2.0. This parameter should therefore not be used any longer.</p> <p>C0248 is included in every LECOM code bank (see C0249).</p> <p>The parameter value is always set to 0 when switching on.</p> <p>LECOM format: VD</p>																																																																																																																																																								

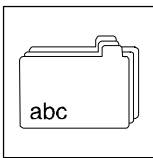

# Appendix

Code	Name	Note
C0249*	LECOM code bank (P2102)	<p>Code bank                      Code number</p> <p><b>0      0      to      255</b> (Factory setting)</p> <p>1      250    to      505</p> <p>2      500    to      755</p> <p>3      750    to      1005</p> <p>4      1000   to      1255</p> <p>5      1250   to      1505</p> <p>6      1500   to      1755</p> <p>7      1750   to      2005</p> <p>8      2000   to      2255</p> <p>9      2250   to      2505</p> <p>10     2500   to      2755</p> <p>11     2750   to      3005</p> <p>12     3000   to      3255</p> <p>13     3250   to      3505</p> <p>14     3500   to      3755</p> <p>15     3750   to      4005</p> <p>The LECOM code bank ensures the compatibility with the master-system drivers according to the LECOM-A/B specification V1.0. The maximum code number is 255. With the code bank, an offset of 250 is added to the code number.</p> <p>The code bank addressing is not effective with extended code addressing (LECOM-A/B specification).</p> <p>The parameter value is always set to 0 when switching on.</p> <p>LECOM format: VD</p>
C1810*	SW labelling (P2102)	<p>33S2102I_xy000</p> <p>Software labelling of the 2102IB fieldbus modules x = main SW version    y = SW subversion</p> <p>LECOM format: VS</p>
C1811*	SW generation (P2102)	<p>Software generation of the 2102IB fieldbus module</p> <p>LECOM format: VS</p>
C1920	Start status (P2102)	<p><b>0      QSP</b></p> <p>1      Controller inhibit</p> <p>LECOM format: VD</p>
C1922	Monitoring selection code (P2102)	<p><b>0      Not active</b></p> <p>1      Controller inhibit</p> <p>2      QSP (quick stop)</p> <p>LECOM format: VD</p>
C1921	Shortened response time (P2102)	<p><b>0      Not active</b></p> <p>1      active</p> <p>LECOM format: VD</p>
C1923	Monitoring time (P2102)	<p>50 to 65535ms</p> <p>LECOM format: VD</p>
C1962	Extended code No.	See fault table

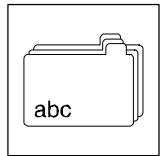

The following list shows the fault numbers which can be read under C1962:

Fault no.	Meaning	Classification
0	No fault	
1	Invalid service designation	Internal fault
2	Invalid call recognition	Internal fault
3	Invalid data type	Application error in the host
4	Invalid subcode number	Application error in the host
5	Invalid code number	Application error in the host
6	Invalid general parameter	Application error in the host
7	Access error: operating status, e.g. controller inhibit	Access error
8	Access error: because operating mode C0001	Access error
9	Access error: parameter only readable	Access error
10	Access error: general	Access error
11	Data block too long	Limit value exceeded
12	Collision with other parameter values	Limit value exceeded
13	Leave value range	Limit value exceeded
14	General limit value exceeding	Limit value exceeded
17	General internal fault	Internal fault
32	General	Communication fault 2102IB <-> controller
33	Time limit exceeded	Communication fault 2102IB <-> controller
34	Frame error	Communication fault 2102IB <-> controller
35	Parity error	Communication fault 2102IB <-> controller
36	Overflow	Communication fault 2102IB <-> controller
37	Handshake	Communication fault 2102IB <-> controller
38	Block memory overflow	Communication fault 2102IB <-> controller
208	Frame error	Communication fault controller <-> 2102IB
209	Overflow error	Communication fault controller <-> 2102IB
210	Check-sum fault in the 2102IB fieldbus module detected	Communication fault controller <-> 2102IB
211	Telegram interruption	Communication fault controller <-> 2102IB
212	Invalid data	Communication fault controller <-> 2102IB
213	Invalid service	Communication fault controller <-> 2102IB
214	Parity error	Communication fault controller <-> 2102IB

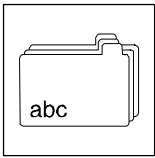

# Appendix

## 8.3 LECOM-A/B protocol

The LECOM-A/B protocol is used to exchange data between Lenze controllers and a host. The LECOM-A/B protocol is based on DIN 66019, ISO 1745 and ANSI X3.28 (category 2.5 and A2, A4). These standards are similar to each other and describe the control mode of a transmission section of a transmission system.

The host, which is the master, can communicate with a slave (Lenze controller) in three modes:

- RECEIVE (see page 8-21)
- SEND (see page 8-23)
- BROADCAST/MULTICAST (see page 8-24)

### 8.3.1 General

The controllers communicate by means of the ASCII code:

	0	1	2	3	4	5	6	7	8	9	0	B	C	D	I	F
0	NUL	SOH	STX	ETX	EOT	ENQ	ACK	BEL	BS	HT	LF	VT	jFF	CR	SO	SI
1	DLE	DC1	DC2	DC3	DC4	NAK	SYN	ETB	CAN	EM	SUB	ESC	FS	GS	RS	US
2	' '	'!'	'"'	'#'	'\$'	'%'	'&'	'''	'('	')'	'**'	'+'	','	'-'	'.'	'/'
3	'0'	'1'	'2'	'3'	'4'	'5'	'6'	'7'	'8'	'9'	':'	','	'<'	'='	'>'	'?'
4	'@'	'A'	'B'	'C'	'D'	'E'	'F'	'G'	'H'	'I'	'J'	'K'	'L'	'M'	'N'	'O'
5	'P'	'Q'	'R'	'S'	'T'	'U'	'V'	'W'	'X'	'Y'	'Z'	'['	'\'	']'	'^'	'_'
6	'`'	'a'	'b'	'c'	'd'	'e'	'f'	'g'	'h'	'i'	'j'	'k'	'l'	'm'	'n'	'o'
7	'p'	'q'	'r'	's'	't'	'u'	'v'	'w'	'x'	'y'	'z'	'{'	' '	'}'	'~'	

Example:

"EOT" = 02<sub>hex</sub> = 2<sub>dec</sub>  
 Character "1" = 31<sub>hex</sub> = 49<sub>dec</sub>

#### Code number (C1, C2)

##### Standard addressing

The meaning of the code numbers and the assigned parameters can be obtained from the code table (see chapter 8.2). When transmitting data, the code number are coded as follows:

The following calculation determines the two ASCII digits from the code number (value range: 0 ... 6229) (value range: 48<sub>dec</sub> ... 127<sub>dec</sub>):

$$C1 = \text{INTEGER}((\text{REMAINDER}(\text{code number}/790)/10)+48_{\text{dec}})$$

$$C2 = \text{REMAINDER}(\text{REMAINDER}(\text{code number}/790)/10) + \text{INTEGER}(\text{code number}/790) \times 10 + 48_{\text{dec}}$$

The INTEGER is the digit before the decimal point, the REMAINDER is an integer.

Example: 13/5 = 2 remainder 3  
 INTEGER(13/5) = 2  
 REMAINDER(13/5) = 3

Example:

Convert code number 1002 in ASCII code C1 and C2:

$$C1_{\text{ASCII}} = \text{INTEGER}((\text{REMAINDER}(1002/790)/10) + 48) = \text{INTEGER}(212/10) + 48 = 21 + 48 = 69 = 45_{\text{hex}} = \text{"E"}_{\text{ASCII}}$$

$$C2_{\text{ASCII}} = \text{REMAINDER}(\text{REMAINDER}(1002/790)/10) + \text{INTEGER}(1002/790) \times 10 + 48 = \text{REMAINDER}(212/10) + 1 \times 10 + 48 = 2 + 10 + 48 = 60 = 3C_{\text{hex}} = \text{"<"}_{\text{ASCII}}$$



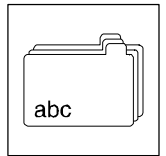

The code number C1002 is converted into the ASCII string "E<", if they are transmitted to the controller by a host.

### Addressing via code bank

With previous LECOM-A/B drivers, only code numbers in the range from 0 to 255 could have been addressed, since these drivers used only one byte as code number. To achieve the addressing of the wider code-number range with these drivers, use the code banking. The code-number range 0 ... 255 is displayed as a window over the whole code-number range. This is controlled via the code C0249 (code bank). Code C0249 can always be accessed via number 249, independent of the currently set code bank.

Assignment:

Code bank	Code offset	Code-number range
0	0	0 ... 255
1	250	250 ... 505
2	500	500 ... 755
3	750	750 ... 1005
4	1000	1000 ... 1255
5	1250	1250 ... 1505
6	1500	1500 ... 1755
7	1750	1750 ... 2005

Note:

Code banking is only active when the standard addressing is being used. If the selected code numbers are higher than 255, the code-number range increases correspondingly. Only the corresponding code-number offset is selected by means of the code bank.

Example:

Set the code bank INTEGER  $(1002/250) = 4$  in C0249 to address the code number 1002. C1002 is then accessed via the code number C02.

### Addressing via input selection

Simple LECOM-A/B drivers, which only use the standard addressing, cannot address subcodes. The input selection C0248 has been developed to offer the possibility of addressing the subcodes. When using the standard addressing, the value entered in C0248 is always considered as the subcode. The code C0248 can always be accessed via number 248, independent of the currently set code bank and the subcode used.

Example:

Enter value 1 in C0248 to address the JOG value 1 in subcode 1. Now subelement 1 is always addressed when accessing C39.



### Tip!

After a subelement has been accessed through C0248, C0248 should be reset to 0 to avoid the addressing of a subelement "by accident" when accessing a code.

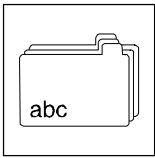

# Appendix

## Extended addressing

Another possibility is the direct addressing of parameters by means of expanded addressing.

!	CH1	CH2	CH3	CH4	SC1	SC2
---	-----	-----	-----	-----	-----	-----

The abbreviations have the following meanings:

- ! The ASCII character "!" = 21<sub>hex</sub> = 33<sub>dec</sub> shows that the expanded addressing is used.
- CH1 to CH4 Code number in hexadecimal code: each character corresponds to a nibble of the code numbers (CH1 is the highest, CH4 is the lowest nibble).
- SC1, SC2 Subcode number in hexadecimal code: Each character corresponds to a nibble of the code number word (SC1 is the highest- and SC2 the lowest nibble).

The following characters can be displayed in the ASCII code:

ASCII	0	1	2	3	4	5	6	7	8	9	0	B	C	D	I	F
dec	48	49	50	51	52	53	54	55	56	57	65	66	67	68	69	70
hex	30	31	32	33	34	35	36	37	38	39	41	42	43	44	45	46

A code number range from 0 to 65535 can be addressed by means of these characters. A maximum of 255 subelements (field elements) can be accessed via one subcode number of each code.

Example:  
1002 = "!03EA00"

## Parameter value (V1 to Vn)

Parameter values can be transmitted in four different formats with the following structures:

- ASCII decimal format (VD)

-	VK1	VK2	VK3	VK4	VK5	VK6	.	NK1	NK2	NK3	NK4
---	-----	-----	-----	-----	-----	-----	---	-----	-----	-----	-----

- ASCII hexadecimal format (VH)

H	VH1	VH2	VH3	VH4	VH5	VH6	VH7	VH8
---	-----	-----	-----	-----	-----	-----	-----	-----

- String format (VS)

S	VS1	VS2	VS3	VS4	VS5	VS6	...	VS240
---	-----	-----	-----	-----	-----	-----	-----	-------

- Octet string format for data blocks (VO)

0	VO1	VO2	VO3	VO4	VO5	VO6	...	VO240
---	-----	-----	-----	-----	-----	-----	-----	-------

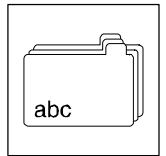

The abbreviations have the following meanings:

VK1 to VK6	Integers
.	Decimal point (if required)
NK1 to NK4	Decimal codes (if required)
"H" (48 <sub>hex</sub> )	Character [H], transfer of parameter values in the ASCII hexadecimal format
VH1 to VH8	1 to 8 hexadecimal characters each [0 to 9; A to F]
"S" (53 <sub>hex</sub> )	Character [S], transfer of parameter values in the string format
VS1 to VS240	1 to 12 visible ASCII characters each (no control characters)
"O" (4F <sub>hex</sub> )	Character [O], transfer of parameter values in the octett string format
VO1 to VO240	Data block in hexadecimal code; Each character corresponds to a nibble of the data block

*Parameter value in the ASCII decimal format (VD)*

The ASCII decimal format (VD) is most often used. The values consist of the following:

- 1 leading negative sign (if required)
- 6 digits before the decimal point (VK1 to VK6)
- 1 decimal point (if required)
- 4 digits after the decimal point (NK1 to NK4) (if required)

Values from -214748.3648 to 214748.3647 can be displayed.



**Tip!**

In the ASCII decimal format (VD), the decimal point must not be transmitted if the value does not have digits after the decimal point.

*Parameter value in ASCII hexadecimal format (VH)*

The LECOM-A/B protocol supports the transmission of hexadecimal parameter values with a length of:

- 2 characters (byte value)
- 4 characters (word/integer value)
- 8 characters (double word/long integer)

In the ASCII hexadecimal format, VH1 is the most significant and VH8 the least significant hexadecimal character.

*Parameter value in the string format (VS)*

By means of the string format (VS) of the protocol it is possible to transmit strings with max. 20 characters in both directions.

The Lenze controller can only send the string parameters (e. g. C200).

*Parameter values in the octett string format (VO)*

The LECOM-A/B protocol includes the octett string format (VO) with which it is possible to transfer data blocks.

The character sequence corresponds to the filing in the memory (ascending order), i. e. the character transmitted first is the data block nibble with the lowest address. The data structure of the data block corresponds to the Intel-memory format with the following definition:

BYTE:	1st high nibble
	2nd low nibble
WORD:	1st high BYTE
	2nd low BYTE
DWORD:	1st high WORD
	2nd low WORD

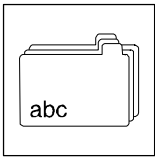

## Appendix

### Controller address (AD1, AD2)

One or more bus devices (slaves) can be selected by means of the controller address which is 2 bytes (AD1, AD2) long. The LECOM-A/B protocol supports the broadcast telegrams, i.e. a telegram is sent to a group or all other bus devices. For this, controller addresses are reserved (see BROADCAST, page 8-24). Controller addresses have the following structure:



The abbreviations have the following meanings:

AD1                ASCII ten-digit of the slave address (0 ... 9; 30 ... 39<sub>hex</sub>)  
 AD2                ASCII one-digit of the slave address (0 ... 9; 30 ... 39<sub>hex</sub>)

### Block-check character (BCC)

The block-check character (BCC) is used to store the transmitted data and is generated according to DIN 66219 (chapter 3).

Because of the program, the block-check character is generated by a XOR link from the following digits of the SEND telegram:

- it starts with the character directly after the STX control character
- it ends directly after the ETX control character
  - BCC can accept the value 00 ... FF<sub>hex</sub>.

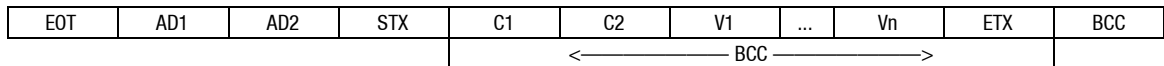

or with the expanded addressing:

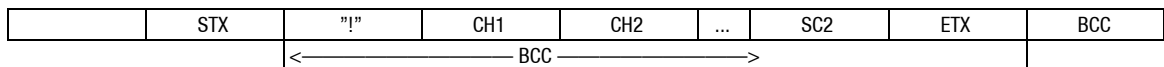

### Telegram response

The Lenze controller must return an acknowledgement to the host. The only exception is the broadcast telegram. This telegram does not require an acknowledgement.

The Lenze controller sends two types of acknowledgements:

- Positive acknowledgement (ACK = 06<sub>hex</sub>), if:
  - no faults occur during the block storage (longitudinal and lateral parity)
  - a valid command (variable address) has been recognized
  - the variable value is within the permissible range
  - the variable value could have been changed
- negative acknowledgement (NAK = 15<sub>hex</sub>), if:
  - one of the above listed conditions cannot be met.
- No acknowledgement, if:
  - a broadcast telegram is send
  - the controller address is not correct

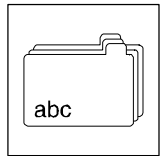

## 8.3.2 RECEIVE

The command RECEIVE is to request parameter values of the Lenze controllers. The code numbers of the requested parameter are transmitted via the RECEIVE telegram using the following structure:

EOT	AD1	AD2	C1	C2	ENQ
-----	-----	-----	----	----	-----

The abbreviations have the following meanings:

EOT (04 <sub>hex</sub> )	End of the (previous) transmission
AD1, AD2	Logic unit address of the slave to be addressed
C1, C2	Code number (two ASCII characters) or extended addressing
ENQ (05 <sub>hex</sub> )	Station request

Structure and meaning of the code numbers (C1, C2) and the controller address (AD1, AD2) are described in the corresponding paragraphs of the chapter SEND (see page 8-23).

### Telegram response

The Lenze controller addressed via a RECEIVE telegram generates one of the following responses:

- The controller could decode the request and is now sending the requested parameter value to the host.

STX	C1	C2	V1	...	Vn	ETX	BCC
-----	----	----	----	-----	----	-----	-----

- The controller could decode the request, however, a check-sum fault (parity fault) occurred during transmission.

STX	C1	C2	?	ETX	BCC
-----	----	----	---	-----	-----

- The controller could not process the request because the requested code number does not exist.

STX	C1	C2	EOT
-----	----	----	-----

The abbreviations have the following meanings:

STX (02 <sub>hex</sub> )	Start of text
C1, C2	Code number (two ASCII characters) or extended addressing
V1 to Vn	Parameter value (n ASCII characters)
ETX (03 <sub>hex</sub> )	End of text
BCC	Block-check character (00 ... FF <sub>hex</sub> )
? (3F <sub>hex</sub> )	ASCII character "?"
EOT (04 <sub>hex</sub> )	End of the (previous) transmission

Structure and meaning of the block-check character (BCC) are described in the corresponding paragraph of the chapter SEND (see page 8-20).

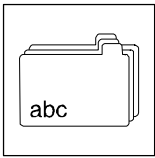

# Appendix

## Examples for a RECEIVE telegram

### Example 1

The current speed setpoint (code number C46) is to be read with the bus address 01 at the controller.

The host sends the following RECEIVE telegram

EOT	0	1	4	6	ENQ
-----	---	---	---	---	-----

The controller can respond in three different ways:

STX	4	6	3	5	.	4	ETX	BCC
-----	---	---	---	---	---	---	-----	-----

Valid request: The current value of the parameter C46 is 35.4 (Hz)

or

STX	4	6	?	ETX	BCC
-----	---	---	---	-----	-----

Invalid request: A check-sum fault (parity fault) occurred during data transmission

or

STX	4	6	EOT
-----	---	---	-----

Invalid request: Parameter C46 does not exist in this controller.

### Example 2

The current operating status (code number C68) is to be read with the bus address 25 for the controller.

The operating status is bit-coded and transmitted in the hexadecimal format.

The host sends the following RECEIVE telegram

EOT	2	5	6	8	ENQ
-----	---	---	---	---	-----

The controller's response:

STX	6	8	H	0	9	0	0	ETX	BCC
-----	---	---	---	---	---	---	---	-----	-----

Valid request: The current value of the parameter C68 is "0900". This means:

TRIP status	not active
Maximum current	not reached
Quick stop	not active
Pulse inhibit status	free
Display of the direction of rotation	CW rotation
Q <sub>min</sub> status	not active
Controller enable	enabled
Operating fault	did not occur
Communication error	did not occur

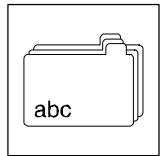

## 8.3.3 SEND

The command SEND is to transmit data from the master to the slave. The master then sends a telegram with the following structure:

EOT	AD1	AD2	STX	C1	C2	V1	...	Vn	ETX	BCC
-----	-----	-----	-----	----	----	----	-----	----	-----	-----

The abbreviations have the following meanings:

EOT (04 <sub>hex</sub> )	End of the (previous) transmission
AD1, AD2	Logic unit address of the slave to be addressed Slaves
STX (02 <sub>hex</sub> )	Start of text
C1, C2	Code number (two ASCII characters)
V1 to Vn	Parameter value (n ASCII characters)
ETX (03 <sub>hex</sub> )	End of text
BCC	Block-check character (00 ... FF <sub>hex</sub> )

In the text section of the telegram, which is embedded between the control characters STX and ETX, the code number (C1, C2) and the corresponding parameter value (V1 to Vn) are transmitted to the slave.

### Example for a SEND telegram

The maximum speed (code number C11) is to be set to the value 95.2 Hz via the bus address 34 at the controller.

The host must send the following SEND telegram:

EOT	3	4	STX	1	1	9	5	.	2	ETX	BCC
-----	---	---	-----	---	---	---	---	---	---	-----	-----

The controller can respond with two different acknowledgements:

ACK

The command could not be processed correctly. The current value of the parameter C11 is 95.2 Hz  
or

NAK

The request could not be processed correctly. The parameter value was not changed.

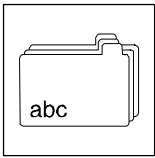

## Appendix

### 8.3.4 BROADCAST / MULTICAST

In a bus network, the command BROADCAST is to address all devices or a group of devices (multicast) at the same time. The structure of the BROADCAST telegram is similar to the structure of the SEND telegram. The only exception is that it does not return an acknowledgement.

The devices can be selected via their controller addresses. The following controller addresses are reserved for a BROADCAST telegram:

controller addresses (reserved)	controller address of groups	ASCII character	
		AD1	AD2
00	all	"0"	"0"
10	11 to 19	"1"	"0"
20	21 to 29	"2"	"0"
30	31 to 39	"3"	"0"
40	41 to 49	"4"	"0"
50	51 to 59	"5"	"0"
60	61 to 69	"6"	"0"
70	71 to 79	"7"	"0"
80	81 to 89	"8"	"0"
90	91 to 99	"9"	"0"

#### Example for a BROADCAST telegram

All controllers are to be stopped when setting controller enable (code number C40 = 0).

The host send the following BROADCAST telegram:

EOT	0	0	STX	4	0	0	ETX	BCC
-----	---	---	-----	---	---	---	-----	-----

The controllers do not return an acknowledgement.

### 8.3.5 Monitoring of the slave response

The master monitors the selected slave. The slave must return a response within a defined time. Under the following circumstances the slave does not return a response to the master (time out):

- The controller address could not be recognized
- A fault (e.g. parity fault) had been detected in one or several characters, including the character "ENQ"
- The transmission path is faulty
- A BROADCAST telegram had been sent
- The hardware does not work properly

If the master does not receive a response within a defined period of time, the transmission is tried again. The number of repetitions is limited.

The monitoring time in the master should be approx. twice as long as the maximum response time.

### 8.3.6 Transmission faults

After a transmission fault, the master can read C0068 and evaluate the communication error in bit 4...7.



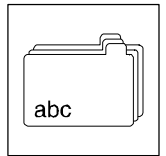

## 8.4 List of abbreviations

Abbreviation	Meaning
ACK	Response for positive acknowledgement of the controller
ASCII	American Standard Code for Information Interchange: 7 bit code with one free parity bit
Ctrl. enable	Controller enable
Ctrl. inhibit	Controller inhibit
DCB	DC-injection brake
EMC	Electromagnetic Compatibility
$f_{dmin}; f_{dmax}$	Minimum/maximum field frequency
$I_{max}$	Current limit
IMP	Pulse inhibit
JOG (JOG1, JOG2, JOG3)	Fixed speed or input for activation of the fixed speed
LECOM	Lenze communication
LECOM-A	Communication medium via RS232 interface and LECOM protocol
LECOM-B	Communication medium via RS485 interface and LECOM protocol
LECOM-LI	Communication medium via optical fibre and LECOM protocol
LEMOG	PC program (for IBM compatible PCs) for drive programming
NAK	Response for negative acknowledgement of the controller
Optical fibre	Optical fibre
PAR	Parameter set changeover
PC	Personal computer
PLC	Programmable logic controller, e. g. SIMATIC S5, SIEMENS
Qmin	Frequency threshold
QSP	Quick stop
RFG	Ramp-function generator; setpoint integrator
RS232	Interface standard
RS485	Interface standard
RxD	Pin name LED (receive display)
SW	Software
TRIP	Operation fault
TxD	Pin name LED (transmission display)
$U_{Gmax}$	DC-bus overvoltage
VD	LECOM format
VH	LECOM format
VS	LECOM format

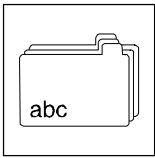

## Appendix

### 8.5 Glossary

Technical term	Meaning
Baud rate	Transmission speed of data in bit/s
Broadcast	Message to all controllers
Code	For input and display (access) of parameter values.
Code number	Addressing of variables according to the format „code-subcode“ (Cxxx-xx). All variables can be accessed via the code names.
Fieldbus	For data exchange between superimposed controls and positioning controls.
Host	PC or PLC
Icon	Sign or symbol with an unambiguous message.
Interface converter	Additional module to adapt data transmissions via RS232 interface cables to RS485 (and vice versa)
LEMO	PC program (for IBM compatible PCs) for drive programming
Multicast	Message to certain controller groups
Nibble	One byte consists of two nibbles: <ul style="list-style-type: none"><li>• LOW nibble (bit 0 to 3)</li><li>• HIGH nibble (bit 4 to 7)</li></ul>
Protocol	LECOM-A/B protocol
Pulse inhibit	The output of the power stage is inhibited because the controller is inhibited, the fault message TRIP is displayed or an overvoltage or undervoltage is applied.
Remaining hazards	Hazards which cannot be eliminated by design
Subcode	Defines the table position of a code
Table position	Some variables may consist of more than one value. If this is the case, the values are entered subsequently. They are accessed by means of the same code name via the subcode.

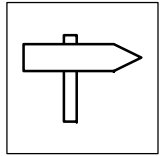

## 8.6 Index

### A

Accessories, 8-1  
for a host, 8-1  
for optical fibres (LECOM-LI), 8-2  
for RS232 (LECOM-A), 8-1  
for RS485 (LECOM-B), 8-2

Acknowledgement, 8-20

negative, 7-1  
positive, 7-1  
TRIP reset, 6-5

Addressing

Code bank addressing, 8-17  
Extended addressing, 8-18  
Standard addressing, 8-16  
Via input selection, 8-17

Appendix, 8-1

Application as directed, 1-2

Application conditions, 3-1

### B

Basic insulation, 4-4

Baud rate, 3-1, 5-1  
*See* Baud rate

BCC, 8-20

Block-check character, 8-20

BROADCAST, 8-24

Example, 8-24

### C

Cable, Optical fibre, 4-9

Character format, 3-1

Code bank, 8-14, 8-17

Code table, 8-3

Commissioning, 5-1

Communication media, 3-1, 3-2

Communication monitoring, 6-4

Communication times, 3-3

Connection

9-pole SubD female plug, 4-2  
Connections of the fieldbus module, 4-1  
Plug-in terminal (2-pole), 4-2  
Plug-in terminal (4-pole), 4-2

Control word, 6-2, 8-5, 8-6, 8-7, 8-8, 8-9, 8-10

Controller

Application as directed, 1-2  
Group formation, 6-3  
Labelling, 1-2

Controller address, 5-1, 6-3, 8-3, 8-20

Controller inhibit, 6-2, 6-5, 8-3

Current consumption, 3-2

### D

Dimensions, 3-2

### E

Electrical data. *See* Ratings

Electrical installation, 4-3

Electrical isolation, 4-4

Extended addressing, 8-18

External supply, 3-2

### F

Fault elimination, 7-1

Fault memory, 8-11

Fault numbers, 8-15

Frequency setpoint, 6-2, 8-3

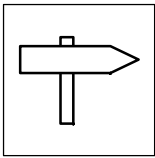

# Contents

## G

- Glossary, 8-26
- Group addressing, 5-1
- Group formation, of controllers, 6-3

## I

- Index, 8-27
- Initial switch-on. *See* Installation
- Input selection, 8-13, 8-17
- Installation
  - Electrical, 4-3
  - Mechanical, 4-3
  - of optical-fibre cables, 4-9
  - Wiring to a host, 4-4
  - Wiring via optical fibre (LECOM-LI), 4-8
  - Wiring via RS232 (LECOM-A), 4-5
  - Wiring via RS485 (LECOM-B), 4-6
- Interface, Reduce response time, 6-4
- Interface converter, 8-2

## L

- Labelling, Controller, 1-2
- LECOM, Protocol, 8-16
- LECOM baud rate. *See* Baud rate
- LECOM code bank. *See* Code bank
- LECOM controller address. *See* Controller address
- LECOM input selection. *See* Input selection
- LECOM-A/B protocol, 6-3, 8-16
- Legal regulations, 1-2
- Liability, 1-2
- List
  - Abbreviations, 8-25
  - Technical term. *See* Glossary
- List of abbreviations, 8-25

## M

- Manufacturer, 1-2
- Monitoring of the slave response, 8-24
- MULTICAST, 8-24

## N

- Network topology
  - Line, 4-6
  - Point-to-point, 4-5
  - Ring, 4-8

## O

- Operating mode, 6-2, 8-3
- Operating status, 8-4
- Operator, 2-1
- Optical fibre
  - Cable, 4-9
  - Installation of the optical-fibre ring, 4-9
- Optical fibre (LECOM-LI), Features, 4-8
- Optical fibre/RS232 converter , 8-2
- Optical-fibre cable
  - Bending radius, 4-9
  - Installation of the optical-fibre ring, 4-9
  - Preparation, 4-9
  - preparation, 4-9
  - Specification, 8-2

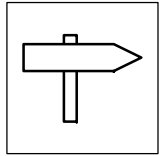

## P

- Packing list, 1-1
- Parameter sets, 6-1
- Parameter setting, 6-1
  - Special features, 820X, 6-5
- Parameter value, 8-18
  - in the ASCII decimal format, 8-19
  - in the ASCII hexadecimal format, 8-19
  - in the octett string format, 8-19
  - in the string format, 8-19
- Parameters
  - Control word (C0135), 6-2
  - Controller inhibit (C040), 6-2
  - Frequency setpoint (C0046), 6-2
  - Meaning of individual, 6-2
  - Operating mode (C0001), 6-2
  - Unit address (C0009), 6-3
- parameters, Name, 8-3
- PC system cable, 8-1
- Personnel, qualified, 2-1
- Plug-in terminal for external supply, Connections, 4-2
- Plug-in terminal for LECOM-B, Connections, 4-2
- Processing time, 3-4
- Protocol, 8-16
  - See LECOM-A/B protocol
  - Code numbers, 8-16

## Q

- Quick stop, 5-1

## R

- Ratings, 3-2
- RECEIVE, 8-21
  - Examples, 8-22
  - Telegram response, 8-21
- RS232 (LECOM-A), Features, 4-5
- RS485 (LECOM-B), Features, 4-6

## S

- Safety information, 2-1
  - Layout, 2-2
  - Other notes, 2-2
  - Warning of damage to material, 2-2
  - Warning of damage to persons, 2-2
- SEND, 8-23
  - Example, 8-23
- Slave response, 8-24
- Software driver, 3-3
- Special features, Parameter setting, 820X, 6-5
- Standard addressing, 8-16
- SubD male plug (9-pole), Connections, 4-2
- Supply voltage
  - External, 4-3
  - Internal, 4-3

## T

- Technical data, 3-1
  - Dimensions, 3-2
  - General data/Application conditions, 3-1
  - Module features, 3-1
  - Ratings, 3-2
- Telegram response, 8-20
- Telegram time, 3-3
- Transmission faults, 8-24
- TRIP reset, 6-5, 8-3
- Troubleshooting, 7-1

## W

- Warranty, 1-2
- Waste disposal, 1-2
- Wiring
  - to a host, 4-4
  - via optical fibres (LECOM-LI), 4-8
  - via RS232 (LECOM-A), 4-5
  - via RS485 (LECOM-B), 4-6

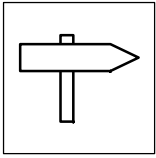

## ***Contents***