



INTORQ

setting the standard

INTORQ BFK457

Electromagnetically released spring-applied brake

Operating Instructions

This documentation applies to ...

BFK457-01...16

Compact-version, optionally with manual release

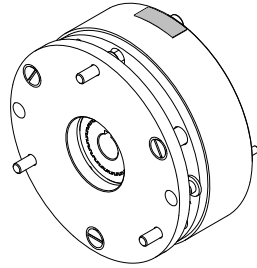

BFK457XX_XXX.iso/dms

Basic-version, optionally with manual release

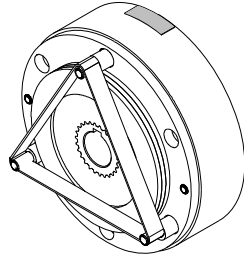

BFK457XX_XXX.iso/dms

Product key

Product key

INTORQ B FK □□□ - □□

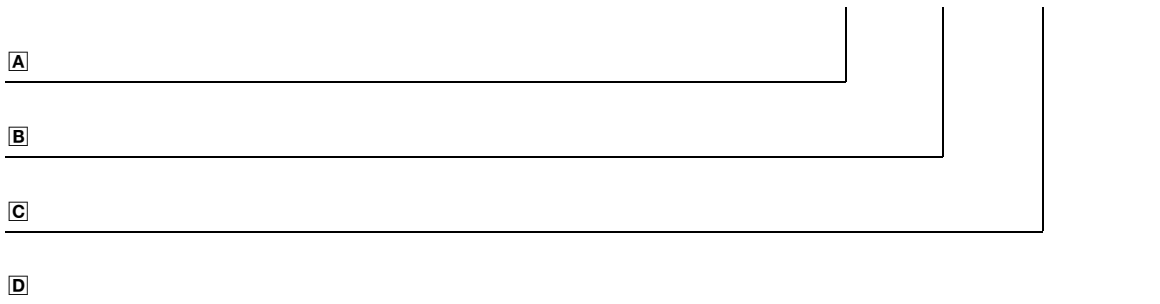

Legend for INTORQ BFK457 product key

A	Product group	Brakes
B	Product family	Spring-applied brakes
C	Type	457
D	Size	01, 02, 03, 04, 05, 06, 08, 10, 12, 14, 16

Not coded: Supply voltage, hub bore, options

Identification

Package label		Example
Manufacturer	Bar code	
Type (see product key)	Type-No.	
Name	Qty. per box	
Rated voltage	Rated brake torque	
Rated power	Packaging date	
Version		
Supplement	CE mark	

BFK457-017.iso/dms

Nameplate		Example
Manufacturer	CE mark	
Type (see product key)	Version	
Rated voltage	Rated power	
Type-No.	Rated brake torque	

BFK457-016.iso/dms

Document history

Material number	Version			Description
399720	1.0	09/1997	TD09	First edition for series
399720	1.1	07/2000	TD09	Address revision Change of rated data
13053267	2.0	09/2002	TD09	All chapters: Completely revised Sizes 10 - 16 added to the Operating Instructions Sizes 06 and 08 modified for spacer user Change of company name Basic and Compact design
13231528	3.0	04/2005	TD09	Change of company name to INTORQ Completely revised, including the sizes 01 and 02
13343901	4.0	07/2010	TD09	Values of brake torque and speed modified (3.2)
13343901	4.1	07/2011	TD00	Cover update
13343901	4.2	03/2012	TD09	Supplementation of the chapter "Maintenance" Connection plans in chapter "Electrical Installation" updated Starting torques, braking torques and speeds in chapter "Characteristics" changed
13343901	5.0	04/2013	TD 09	Note regarding spare parts list has been supplemented Supplemented chapter of spare parts order Table "Size of cheese head screws" inserted Note regarding installation of the basic design Note regarding shaft-hub connection

i Contents

1	Preface and general information	6
1.1	About these Operating Instructions	6
1.2	Terminology used	6
1.3	Conventions used	6
1.4	Abbreviations used	7
1.5	Notes used	8
1.6	Scope of supply	9
1.7	Disposal	9
1.8	Drive systems	9
1.9	Legal regulations	10
2	Safety instructions	11
2.1	General safety information	11
2.2	Application as directed	12
3	Technical data	13
3.1	Product description	13
3.2	Characteristics	15
3.3	Operating times	18
3.4	Friction work / operating frequency	20
3.5	Emission	21
4	Mechanical installation	22
4.1	Important notes	22
4.2	Necessary tools	22
4.3	Mounting	23
4.4	Installation	23
5	Electrical installation	27
5.1	Electrical connection	27
5.2	Bridge/half-wave rectifiers (option)	29
6	Commissioning and operation	32
6.1	Important notes	32
6.2	Function checks before commissioning	32
6.3	Commissioning	33
6.4	During operation	34
7	Maintenance/repair	35
7.1	Wear of spring-applied brakes	35
7.2	Inspections	36
7.3	Maintenance operations	37
7.4	Spare-parts list	40
7.5	Spare parts order	42

i Contents



8	Troubleshooting and fault elimination	43
---	---	----

1 Preface and general information

1.1 About these Operating Instructions

- These Operating Instructions will help you to work safely on and with the spring-applied brake with electromagnetic release. They contain safety instructions that must be followed.
- All persons working on or with the electromagnetically released spring-applied brakes must have the Operating Instructions available and observe the information and notes relevant for them.
- The Operating Instructions must always be in a complete and perfectly readable condition.

1.2 Terminology used

	Term	In the following text used for
	Spring-applied brake	Spring-applied brake with electromagnetic release
	Drive system	Drive systems with spring-applied brakes and other drive components

1.3 Conventions used

This documentation uses the following conventions to distinguish different types of information:

Numeric notation	Decimal separator	Point	The decimal point is always used. For example: 1234.56
	Symbols	Page reference	Reference to another page with additional information For example: □ 16 = see page 16
	Document reference	☞	Reference to another documentation with additional information For example: ☞ Operating instructions
	Wildcard	□	Wildcard for options, selections For example: BFK458-□□ = BFK458-10

1 Preface and general information

1.4 Abbreviations used

Letter symbol	Unit	Name
I	A	Current
I _H	A	Holding current, at 20 °C and withstand voltage
I _L	A	Release current, at 20 °C and release voltage
I _N	A	Rated current, at 20 °C and rated voltage
M _A	Nm	Tightening torque of the fixing screws
M _K	Nm	Characteristic torque of the brake, characteristic value of a relative speed of 100 rpm
n _{max}	rpm	Maximum occurring speed during the slipping time t ₃
P _H	W	Coil power during holding, at voltage change-over and 20 °C
P _L	W	Coil power during release, at voltage change-over and 20 °C
P _N	W	Rated coil power, at rated voltage and 20 °C
Q	J	Quantity of heat/energy
Q _E	J	Maximally permissible friction energy for one-time switching, thermal parameter of the brake
Q _R	J	Braking energy, friction energy
Q _{Smax}	J	Maximally permissible friction energy for cyclic switching, depending on the operating frequency
R _m	N/mm ²	Tensile strength
R _N	Ohms	Rated coil resistance at 20 °C
R _Z	µm	Averaged surface roughness
S _h	1/h	Operating frequency, i.e. the number of switching operations evenly spread over the time unit
S _{hue}	1/h	Transition operating frequency, thermal parameter of the brake
S _{hmax}	1/h	Maximally permissible operating frequency, depending on the friction energy per switching operation
s _L	mm	Air gap, i.e. lift of the armature plate while the brake is switched
s _{LN}	mm	Rated air gap
s _{Lmin}	mm	Minimum air gap
s _{Lmax}	mm	Maximum air gap
t ₁	ms	Engagement time, sum of the delay time and braking torque rise time $t_1 = t_{11} + t_{12}$
t ₂	ms	Disengagement time, time from switching the stator until reaching 0.1 M _{rated}
t ₃	ms	Slipping time, operation time of the brake (according to t ₁₁) until standstill
t ₁₁	ms	Delay time during engagement, time from voltage switch-off to the start of torque rise
t ₁₂	ms	Rise time of the braking torque, time from the start of torque rise until reaching the braking torque
t _{ue}	s	Overexcitation time
U	V	Voltage
U _H	V DC	Withstand voltage, during voltage change-over
U _L	V DC	Release voltage, during voltage change-over
U _N	V DC	Rated coil voltage; in the case of brakes requiring a voltage change-over, U _{rated} equals U _L

1 Preface and general information

1.5 Notes used

The following pictographs and signal words are used in this documentation to indicate dangers and important information:

Safety instructions



Structure of safety instructions:

 **Danger!**
 Characterises the type and severity of danger



Note
 Describes the danger

Possible consequences:
 ■ List of possible consequences if the safety instructions are disregarded.

Protective measure:
 ■ List of protective measures to avoid the danger.

Pictograph and signal word	Meaning
 Danger!	Danger of personal injury through dangerous electrical voltage Reference to an imminent danger that may result in death or serious personal injury if the corresponding measures are not taken.
 Danger!	Danger of personal injury through a general source of danger Reference to an imminent danger that may result in death or serious personal injury if the corresponding measures are not taken.
 Stop!	Danger of property damage Reference to a possible danger that may result in property damage if the corresponding measures are not taken.

Application notes

Pictograph and signal word	Meaning
 Note!	Important note to ensure troublefree operation
 Tip!	Useful tip for simple handling
	Reference to another documentation

1 Preface and general information

1.6 Scope of supply

After receipt of the delivery, check immediately whether it corresponds to the accompanying papers. INTORQ does not grant any warranty for deficiencies claimed subsequently.

- Claim visible transport damage immediately to the forwarder.
- Claim visible deficiencies / incompleteness immediately to INTORQ GmbH & Co.KG.

1.7 Disposal

The spring-applied brake consists of different types of material.

- Recycle metals and plastics.
- Ensure professional disposal of assembled PCBs according to applicable environmental regulations.

1.8 Drive systems

Labelling

Drive systems and components are unambiguously designated by the indications on the nameplate.

Manufacturer: INTORQ GmbH & Co KG, Wülmser Weg 5, D-31855 Aerzen

- The spring-applied INTORQ brake is also delivered in single modules and individually combined to its modular design. The data - package labels, nameplate, and type code in particular - apply to one complete stator.
- If single modules are delivered, the labelling is missing.

1 Preface and general information

1.9 Legal regulations

Liability

- The information, data and notes in this documentation met the state of the art at the time of printing. Claims referring to products which have already been supplied cannot be derived from the information, illustrations and descriptions.
- We do not accept any liability for damage and operating interference caused by:
 - inappropriate use
 - unauthorised modifications to the product
 - improper working on and with the product
 - operating faults
 - disregarding the documentation

Warranty

- Terms of warranty: see terms of sale and delivery of INTORQ GmbH & Co. KG.
- Warranty claims must be made to INTORQ immediately after detecting defects or faults.
- The warranty is void in all cases where liability claims cannot be made.

2 Safety instructions

2.1 General safety information

- INTORQ components ...
 - ... must only be applied as directed.
 - ... must not be commissioned if they are noticeably damaged.
 - ... must not be technically modified.
 - ... must not be commissioned if they are mounted and connected incompletely.
 - ... must not be operated without the required covers.
 - ... can hold live as well as moving or rotary parts during operation according to their degree of protection. Surfaces may be hot.
- For INTORQ components ...
 - ... the documentation must always be kept at the installation site.
 - ... only permitted accessories are allowed to be used.
 - ... only original spare parts of the manufacturer are allowed to be used.
- All specifications of the corresponding enclosed documentation must be observed.
This is vital for a safe and trouble-free operation and for achieving the specified product features.
- Only qualified, skilled personnel are permitted to work on and with INTORQ components.
In accordance with IEC 60364 or CENELEC HD 384, qualified, skilled personnel are persons ...
 - ... who are familiar with the installation, mounting, commissioning, and operation of the product.
 - ... who have the qualifications necessary for their occupation.
 - ... who know and apply all regulations for the prevention of accidents, directives, and laws relevant on site.
- Risk of burns!
 - Surfaces may be hot during operation! Provide for protection against accidental contact.
- Risk of injury due to a rotating shaft!
 - Wait until the motor is at standstill before you start working on the motor.
- The friction lining and the friction surfaces must by no means have contact to oil or grease since even small amounts reduce the brake torque considerably.
- The brake is designed for operation under the environmental conditions that apply to IP54. Because of the numerous possibilities of using the brake, it is however necessary to check the functionality of all mechanical components under the corresponding operating conditions.

2 Safety instructions

2.2 Application as directed

- Drive systems
 - are intended for use in machinery and systems.
 - must only be used for the purposes ordered and confirmed.
 - must only be operated under the ambient conditions prescribed in these Operating Instructions.
 - must not be operated beyond their corresponding power limits.

Any other use shall be deemed inappropriate!

Possible applications of the INTORQ spring-applied brake

- Humidity: no restrictions
 - In case of formation of condensed water and moisture: provide for appropriate ventilation to ensure that all components will dry quickly.
- Ambient temperature:
 - -20 °C to +40 °C (standard)
- At high humidity and low temperature:
 - Take measures to protect armature plate and rotor from freezing.
- Protect electrical connections against contact.

3 Technical data

3.1 Product description

3.1.1 Structure and function

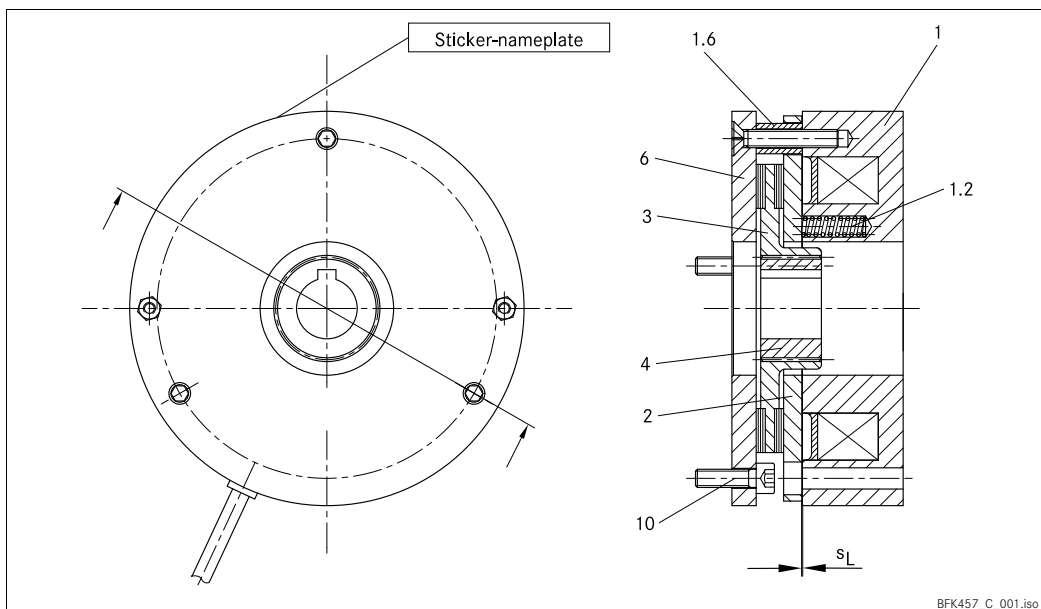

Fig. 1 Spring-applied brake BFK457-06...16 Compact, completely mounted with rotor and flange

- | | | |
|-------------------------|------------------|------------------------------|
| 1 Complete stator | 2 Armature plate | 6 Flange |
| 1.2 Compression springs | 3 Complete rotor | 10 Cheese head screw DIN 912 |
| 1.6 Spacer | 4 Hub | |

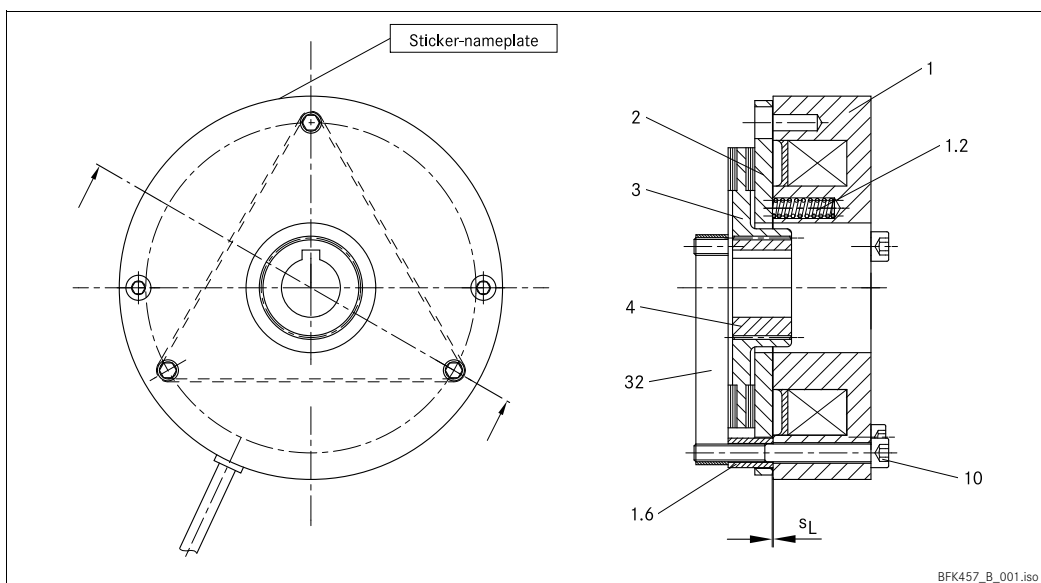

Fig. 2

- | | | |
|-------------------------|------------------|------------------------------------|
| 1 Complete stator | 2 Armature plate | 6 Flange |
| 1.2 Compression springs | 3 Complete rotor | 10 Cheese head screw DIN 912 |
| 1.6 Spacer | 4 Hub | 32 Elastic band (shipping bracket) |

3 Technical data

This spring-applied brake is a single-disk brake with two friction surfaces. The braking torque is generated by several compression springs (1.2) by friction locking. The brake is released electromagnetically.

The spring-applied brake converts mechanical work and kinetic energy into heat. For operating speed, see chapter 3.2 Rated data. Due to the static brake torque, the brake can hold loads without speed difference. Emergency braking is possible at high speed, see chapter 3.2 Rated data. The more friction work the higher the wear. Please take into account that the friction value and thus the brake torque depend on the speed.

Spacer bushes (1.6) are used for this spring-applied brake.



Note!

Air gap adjustment:

- BFK457 size 06...16 Basic
 - Adjustment not possible.
 - When the wear limit is reached, replace the **rotor**.
- BFK457 size 01...16 Compact
 - Adjustment not possible.
 - When the wear limit is reached, replace the **brake**.

3.1.2 Braking

During braking the rotor (3) axially slidable on the hub (4) is pressed against the friction surface by the inner and outer springs (1.2) via the armature plate. The asbestos-free friction linings ensure a high braking torque and low wear. The braking torque transmission between hub (4) and rotor (3) is effected by means of tothing.

3.1.3 Brake release

In the braked state, there is an air gap "s_L" between the stator (1) and the armature plate (2). To release the brake, the coil of the stator (1) is excited with the DC voltage provided. The magnetic force generated attracts the armature plate (2) towards the stator (1) against the spring force. The rotor (3) is then released and can rotate freely.

3 Technical data

3.1.4 Project planning notes

- The brakes are dimensioned in such a way that the given characteristic torques are reached safely after a short run-in process.
- Due to the fluctuating properties of the organic friction linings used and the alternating environmental conditions, deviations of the given braking torques may occur. These must be considered by corresponding safety measures in the dimensioning process. Especially with humidity and alternating temperatures, an increased breakaway torque may occur after a long downtime.
- If the brake is used as a pure holding brake without dynamic load, the friction lining must be reactivated regularly.

3.2 Characteristics

Type	Rated brake torque at $\Delta n=100$ rpm	Air gap s_L		Moment of inertia of the rotor	Brake mass	
	M_K [Nm]	rated ¹⁾ [mm]	max. [mm]	[kg cm ²]	Compact [kg]	Basic [kg]
BFK457-01	0.12	0.1 ^{+0.08} _{-0.05}	0.35	0.0025	0.2	—
	0.25		0.23			
BFK457-02	0.25	0.1 ^{+0.08} _{-0.05}	0.35	0.010	0.25	—
	0.5		0.23			
BFK457-03	0.5	0.15 ± 0.1	0.4	0.021	0.4	—
	1		0.3			
BFK457-04	1	0.15 ± 0.1	0.4	0.058	0.5	—
	2		0.3			
BFK457-05	2	0.15 ± 0.1	0.4	0.105	0.7	—
	4		0.3			
BFK457-06	4	0.2 ± 0.1	0.6	0.130	1.1	0.9
	6		0.4			
BFK457-08	8	0.2 ± 0.1	0.6	0.450	1.9	1.5
	12		0.45			
BFK457-10	16	0.3 ± 0.1	0.7	2.000	3.8	3.0
	23		0.5			
BFK457-12	32	0.3 ± 0.1	0.8	4.500	5.7	4.7
	46		0.5			
BFK457-14	60	0.3 ± 0.1	0.8	6.300	8.6	7.1
	90		0.5			
BFK457-16	80	0.3 ± 0.1	0.9	15.000	12.0	10.0
	125		0.6			

1) Minimum air gap, effective value results from the sum tolerances of the single components.

Tab. 1 General brake characteristics

3 Technical data

Type	Outer diameter [mm]	Pitch circle		Minimum thread depth of motor end shield		Tightening torque M _A [Nm]
		∅ [mm]	Thread	Basic [mm]	Compact [mm]	
BFK457-01	37	32	2 x M2.5	—	4	0.7
BFK457-02	47	40	2 x M3	—	4	1.3
BFK457-03	58	48	3 x M3	—	6	
BFK457-04	67	58		—	6	
BFK457-05	77	66	3 x M4	—	7	3.0
BFK457-06	84	72		11	8	
BFK457-08	102	90	3 x M5	14	11	5.9
BFK457-10	130	112	3 x M6	14	14	10.1
BFK457-12	150	132		14	14	
BFK457-14	165	145	3 x M8	16	16	24.6
BFK457-16	190	170		16	16	

Fixing screws (cheese head screws according to DIN 912) are included in the scope of delivery

Tab. 2 Mounting data



Stop!

- It is absolutely required that the minimum thread depth of the end shield is complied with, Tab. 2.
- If the required thread depth is not maintained, the fixing screws may run onto the root. This has the effect that the required preload force is no longer established - the brake is no longer securely fastened!
- The material of the end shield must have a tensile strength of $R_m \geq 250 \text{ N/mm}^2$!

Type	Brake torque at Δn_0 [Nm]			Max. speed Δn_{0max} [rpm]
	1500	3000	max.	
BFK457-01	0.11	0.10	0.09	5000
BFK457-02	0.23	0.21	0.18	
BFK457-03	0.45	0.42	0.35	
BFK457-04	0.89	0.82	0.68	
BFK457-05	1.76	1.62	1.34	6000
BFK457-06	3.5 5.2	3.2 4.8	3.0 4.4	
BFK457-08	6.8 10.2	6.2 9.3	5.8 8.8	5000
BFK457-10	13.3 19.1	12.2 17.5	11.7 16.8	4000
BFK457-12	25.9 37.3	23.7 34	23.4 33.6	3600
BFK457-14	48 72	43.8 65.7	43.2 64.8	
BFK457-16	63.2 98.8	57.6 90	56.0 87.5	

Tab. 3 Rated torques

3 Technical data

Type	Electrical power P_N [W]	Voltage U [V]	Rated current I_N [A]	Coil resistance R_N [Ω]		
				rated	max.	min.
BFK457-01	5	24 205	0.21 0.02	115.3 8413	121.1 8883.7	109.5 7992.4
BFK457-02	6.6		0.28 0.03	87.3 6372	91.7 6690.6	82.9 6053.4
BFK457-03	9		0.38 0.04	64.0 5128	67.2 5384.4	60.8 4871.6
BFK457-04	11.5		0.48 0.06	50.1 4205	52.6 4415.3	47.6 3994.8
BFK457-05	13		0.54 0.06	44.3 3184.2	46.5 3343.4	42.1 3025
BFK457-06	20		0.83 0.10	28.8 2101	30.24 2269	27.36 19.33
BFK457-08	28 25		1.17 0.12	20.57 1681	21.6 1807	19.54 1555
BFK457-10	30 33		1.25 0.16	19.2 1273	20.16 1356	18.24 1191
BFK457-12	40		1.67 0.20	14.4 1051	14.83 1082	13.97 1019
BFK457-14	50 53 55		24 42 205	2.08 1.26 0.27	11.52 33.28 764	11.87 34.28 787
BFK457-16	55	2.29 1.31 0.27		10.47 32.07 765	10.78 33.03 787	10.16 31.11 742

Tab. 4 Coil data

3 Technical data

3.3 Operating times

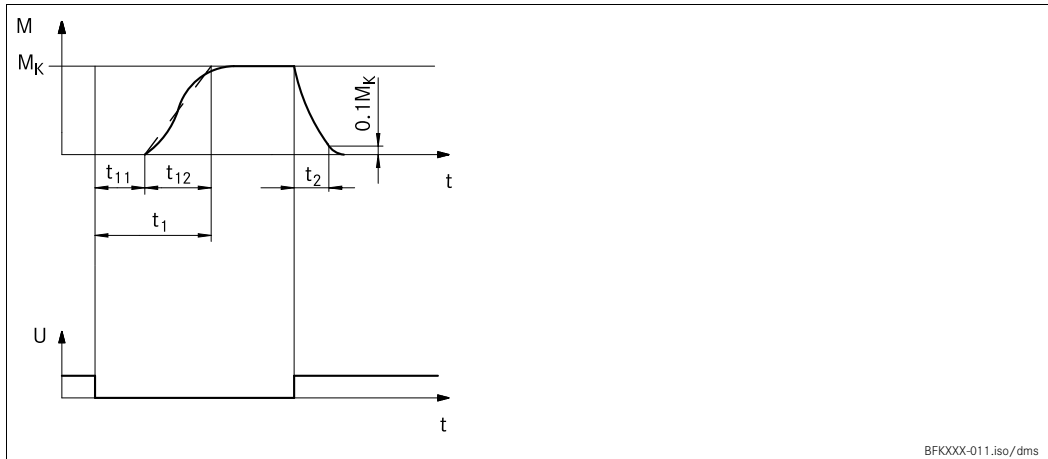

Fig. 3 Operating times of the spring-applied brakes

- | | | | |
|-------|---|----------|----------------------------------|
| t_1 | Engagement time | t_{11} | Reaction delay during engagement |
| t_2 | Disengagement time (up to $M = 0.1 M_K$) | t_{12} | Rise time of the brake torque |
| M_K | Characteristic torque | U | Voltage |

Type	Rated torque at $\Delta n=100$ rpm M_K ¹⁾ [Nm]	Switching energy per switching Q_E [J]	Transition operating frequency S_{hue} [h ⁻¹]	Operating times [ms] at s_{LN} and $0.7 I_N$			
				DC engagement			Disengagement t_2
				t_{11}	t_{12}	t_1	
BFK457-01	0.12	200	160	2	9	11	17
IBFK457-02	0.25	400	125	3	5	8	17
BFK457-03	0.5	800	100	5	7.5	12.5	18
BFK457-04	1	1200	90	9	9	18	23
BFK457-05	2	1800	80	10	16	26	35
BFK457-06	4	3000	79	29	19	48	37
BFK457-08	8	7500	50	60	35	95	42
BFK457-10	16	12000	40	35	60	95	100
BFK457-12	32	24000	30	45	53	98	135
BFK457-14	60	30000	28	50	57	107	240
BFK457-16	80	36000	27	71	50	121	275

1) Minimum brake torque when all components are run in

Tab. 5 Switching energy - operating frequency - operating times

3 Technical data

Engagement time

The transition from brake-torque free state to holding braking torque is not free of time lags.

Short brake engagement times are vital for emergency braking. DC switching together with a suitable spark suppressor must therefore be provided.

- The engagement times are valid for DC switching with a spark suppressor.
 - Spark suppressors are available for the rated voltages.
 - Connect the spark suppressors in parallel to the contact. If this is not admissible for safety reasons, e.g. with hoists and lifts, the spark suppressor can also be connected in parallel to the brake coil.
 - Circuit proposals:  27
- If the drive system is operated with a frequency inverter so that the brake will not be deenergised before the motor is at standstill, AC switching is also possible (not applicable to emergency braking).

Disengagement time

The disengagement time is the same for DC and AC switching. The disengagement times specified always refer to the control with overexcitation.

3 Technical data

3.4 Friction work / operating frequency

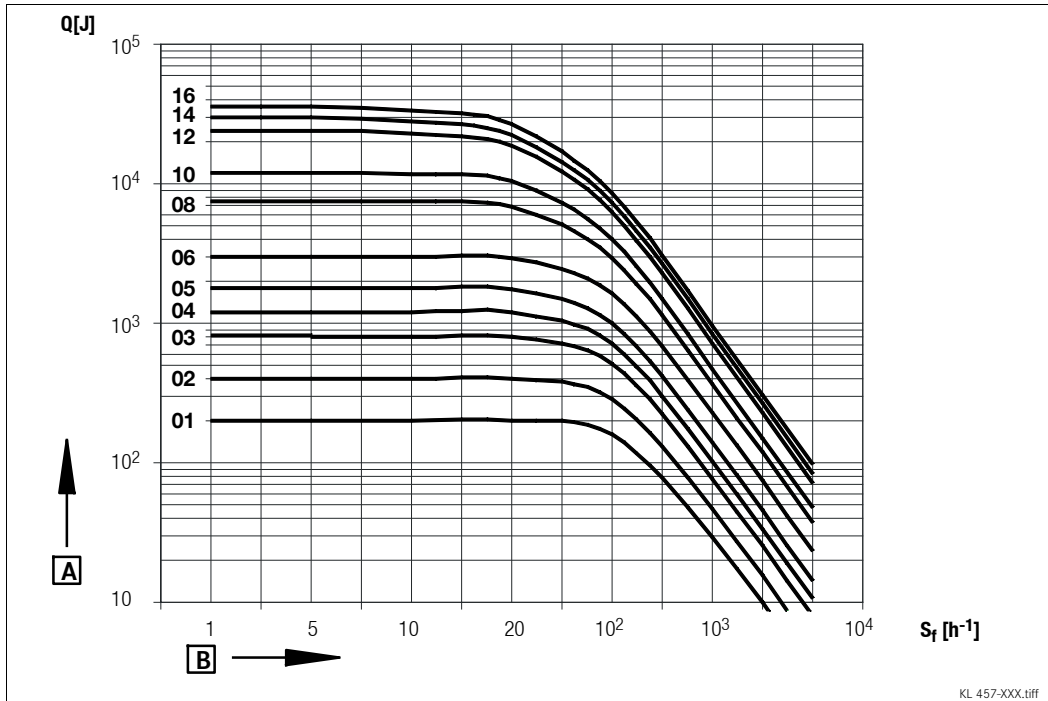

Fig. 4 Switching energy as a function of the operating frequency

A switching energy
 B operating frequency

$$S_{hmax} = \frac{-S_{hue}}{\ln\left(1 - \frac{Q_R}{Q_E}\right)} \quad Q_{smax} = Q_E \left(1 - e^{-\frac{S_{hue}}{S_h}}\right)$$

The permissible operating frequency S_{hmax} depends on the quantity of heat Q_R (see Fig. 4). If the operating frequency S_h is specified, the permissible quantity of heat Q_{smax} will result.

With high speed and friction work, the wear increases strongly, because very high temperatures occur at the friction faces for a short time.

3 Technical data

3.5 Emission

Electromagnetic compatibility

**Note!**

The user must ensure compliance with EMC Directive 2004/108/EC using appropriate controls and switching devices.

If an INTORQ rectifier is used for the DC switching of the spring-applied brake and if the operating frequency exceeds five switching operations per minute, the use of a mains filter is required.

If the spring-applied brake uses a rectifier of another manufacturer for the switching, it may become necessary to connect a spark suppressor in parallel with the AC voltage. Spark suppressors are available on request, depending on the coil voltage.

Heat

Since the brake converts kinetic energy as well as mechanical and electrical energy into heat, the surface temperature varies considerably, depending on the operating conditions and possible heat dissipation. Under unfavourable conditions, the surface temperature can reach 130 °C.

Noises

The switching noises during engagement and disengagement depend on the air gap "s_L" and the brake size.

Depending on the natural oscillation after installation, operating conditions and state of the friction faces, the brake may squeak during braking.

Others

The abrasion of the friction parts produces dust.

4 Mechanical installation

4.1 Important notes





Stop!



Toothed hub and screws must not be lubricated with grease or oil!

4.1.1 Design of end shield and motor shaft

- Comply with the mentioned minimum requirements regarding the end shield and the motor shaft to ensure a correct function of the brake.
- The diameter of the shaft shoulder must not be greater than the tooth root diameter of the hub.
- The form and position tolerances exclusively apply to the materials mentioned. If other materials are used, please contact INTORQ.
- The brake flange must be supported by the end shield across the full surface.

4.2 Necessary tools

Type	Torque wrench  Measuring range [Nm]	Bit for hexagon socket screws  Wrench size [inch]
BFK457-01	0.3 - 4	2 x 1/4" square 50 mm long
BFK457-02		2.5 x 1/4" square 50 mm long
BFK457-03		
BFK457-04		
BFK457-05		
BFK457-06	0.5 - 13	3 x 1/4" square 55 mm long
BFK457-08		4 x 1/4" square 55 mm long
BFK457-10	3 - 40	5 x 1/2" square 180 mm long
BFK457-12		
BFK457-14	20 - 100	6 x 1/2" square 140 mm long
BFK457-16		

Feeler gauge 	Caliper gauge 	Multimeter 

4 Mechanical installation

4.3 Mounting

4.3.1 Preparation

1. Unpack spring-applied brake.
2. Check for completeness.
3. Check nameplate data, especially rated voltage.

4.4 Installation

4.4.1 Installation of the hub onto the shaft



Note!

The dimensioning of the shaft-hub connection is the responsibility of the customer. It must be ensured that the bearing length of the keyway is just as long as the length of the hub.

- Tensile strength of the hub material:
 - Size 03 - 16: Tensile strength $R_m > 460 \text{ N/mm}^2$
 - Size 01/02: Tensile strength $R_m > 500 \text{ N/mm}^2$



Stop!

Square hubs must be used for sizes 01 and 02!

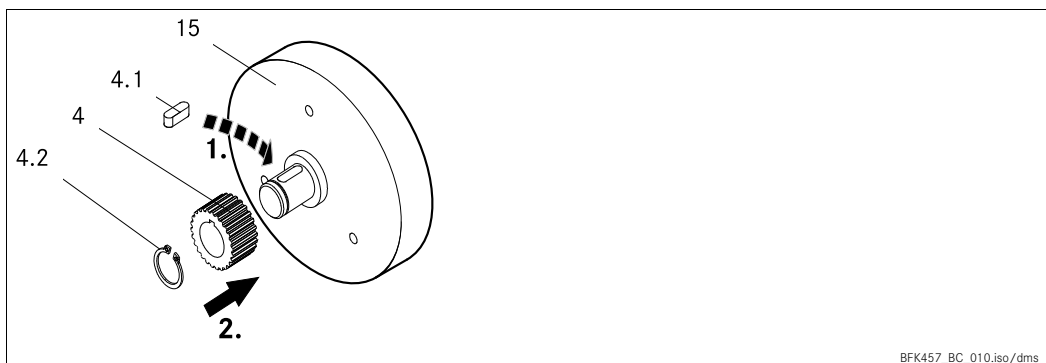

Fig. 5 Mounting the hub onto the shaft

4	Hub	4.1	Keyway
4.2	Circlip	15	End shield

4. Press hub (4.0) onto the shaft
5. Secure hub against axial displacement, e.g. using a circlip (4.2).





Stop!

In reverse operation, it is recommended to additionally glue the hub to the shaft!

4 Mechanical installation

4.4.2 Installation of the brake

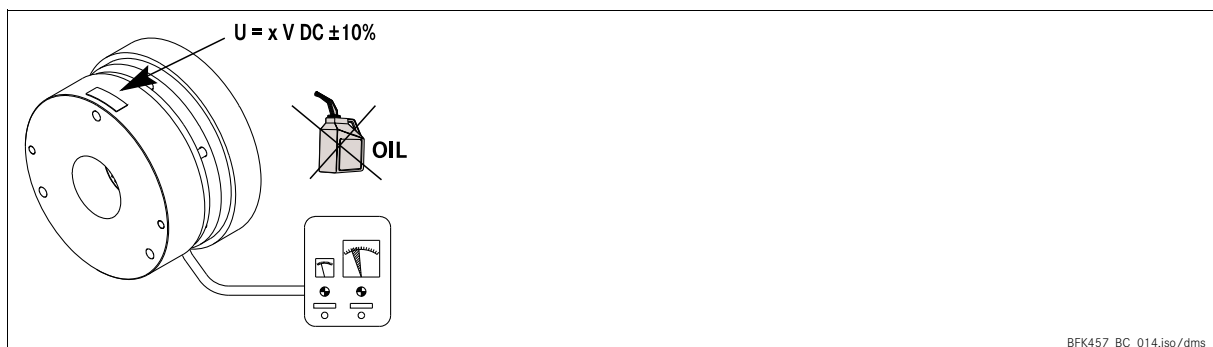
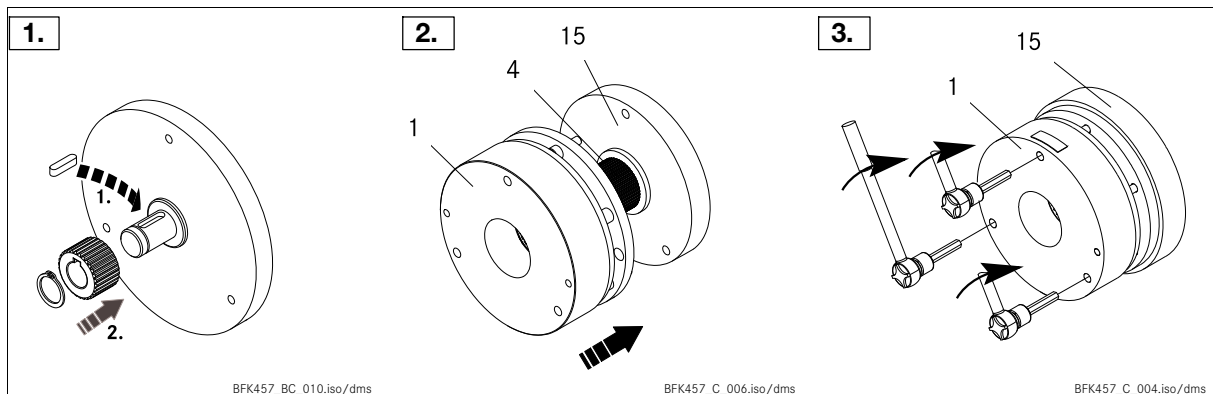

4.4.2.1 INTORQ BFK457-01...16, compact design

1. Installation of the hub (4),  23.
2. Push the spring-applied brake (1) onto the hub (4).
3. In order to fix it screw the spring-applied brake (1) onto the end shield (15) using the integrated cheese head screws (10).
 - Tighten the cheese head screws (10) evenly, tightening torques  15 - use torque wrench.



4 Mechanical installation

4.4.2.2 INTORQ BFK457-06... 16, basic design

1. Installation of the hub (4),  23
2. Push the spring-applied brake (1) onto the hub (4).
3. Tighten the cheese head screws (10) slightly to fix the brake (screws do just bite), remove the transport locking device (rubber band 32).
4. Tighten the cheese head screws (10) evenly, (tightening torques  15 - use torque wrench).
5. Remove the cheese head screws (10.1).

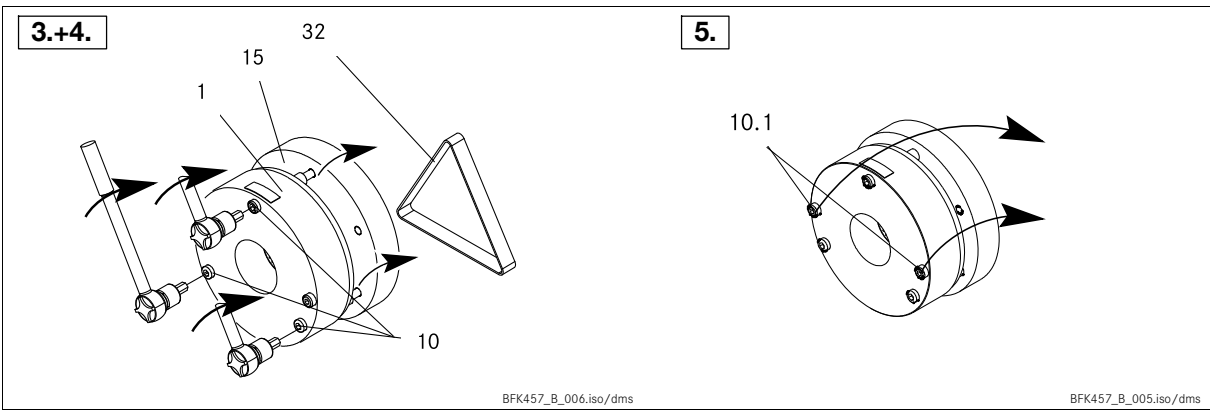
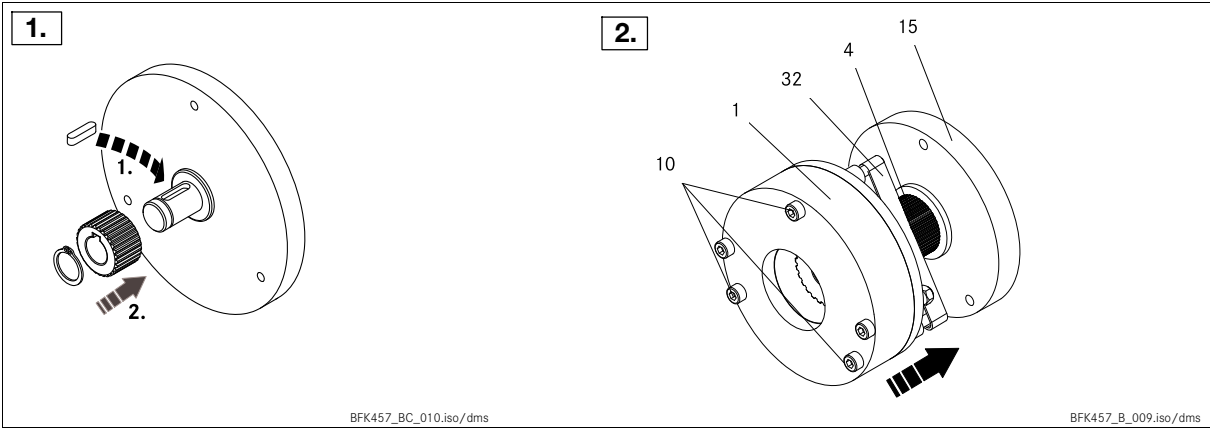

 **Note!**
 To ensure trouble-free operation, the cheese head screws (10.1, step 4) must be removed evenly, otherwise the armature plate will get jammed.

4 Mechanical installation

Type	Size of cheese head screw pos. 10.1
BFK457-06	2 x M4 x 30
BFK457-08	2 x M5 x 35
BFK457-10	2 x M5 x 40
BFK457-12	2 x M5 x 45
BFK457-14	2 x M6 x 60
BFK457-16	2 x M6 x 60

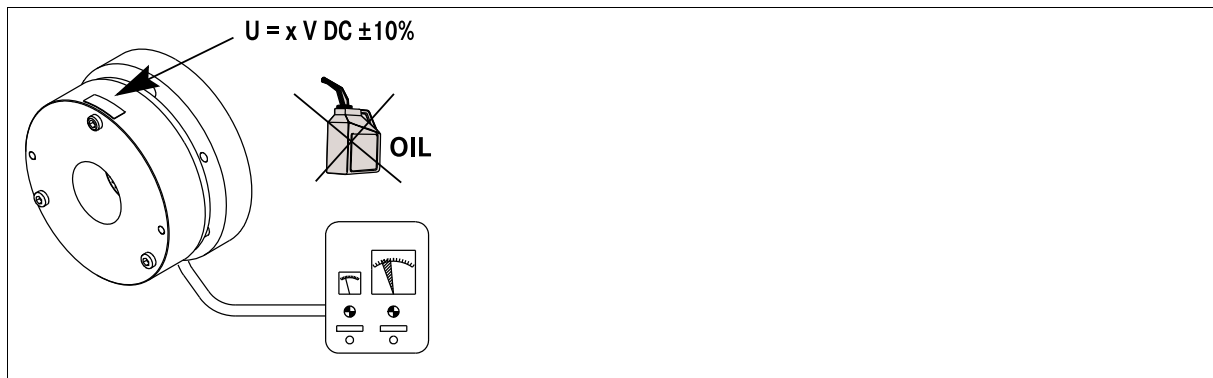

5 Electrical installation

5.1 Electrical connection

5.1.1 Important notes

STOP **Stop!**

- If emergency switching off is carried out without the required suppressor circuit, the control unit may be destroyed.
- Observe the correct polarity of the suppressor circuit!

Danger!

- Electrical connection must only be carried out by skilled personnel!
- Connections must only be made when the equipment is de-energised! Danger through unintended starts or electric shocks.

STOP **Stop!**

- It must be ensured that the supply voltage corresponds to the nameplate data.
- Voltages must be adapted to the local environment!



Tip!

Compare the coil voltage of the stator to the DC voltage of the installed rectifier.

5.1.2 Circuit proposals

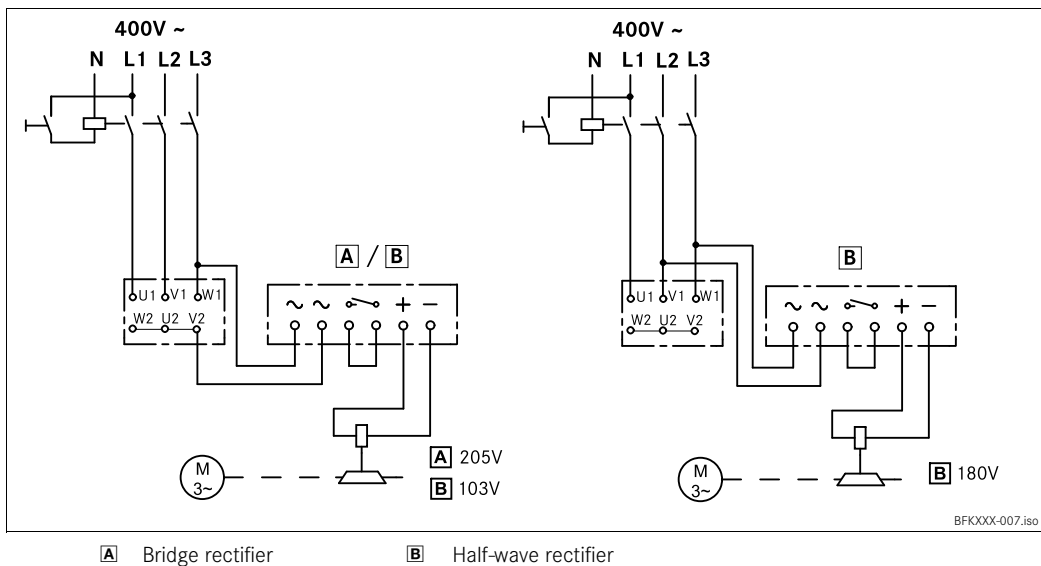

Fig. 6 Delayed engagement

5 Electrical installation

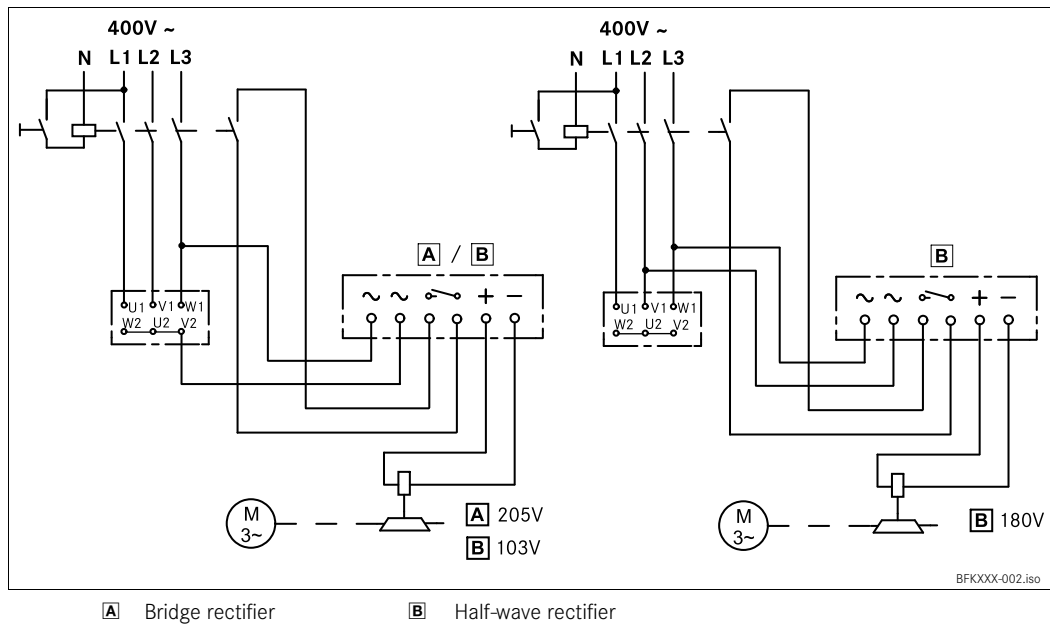

Fig. 7 Fast engagement

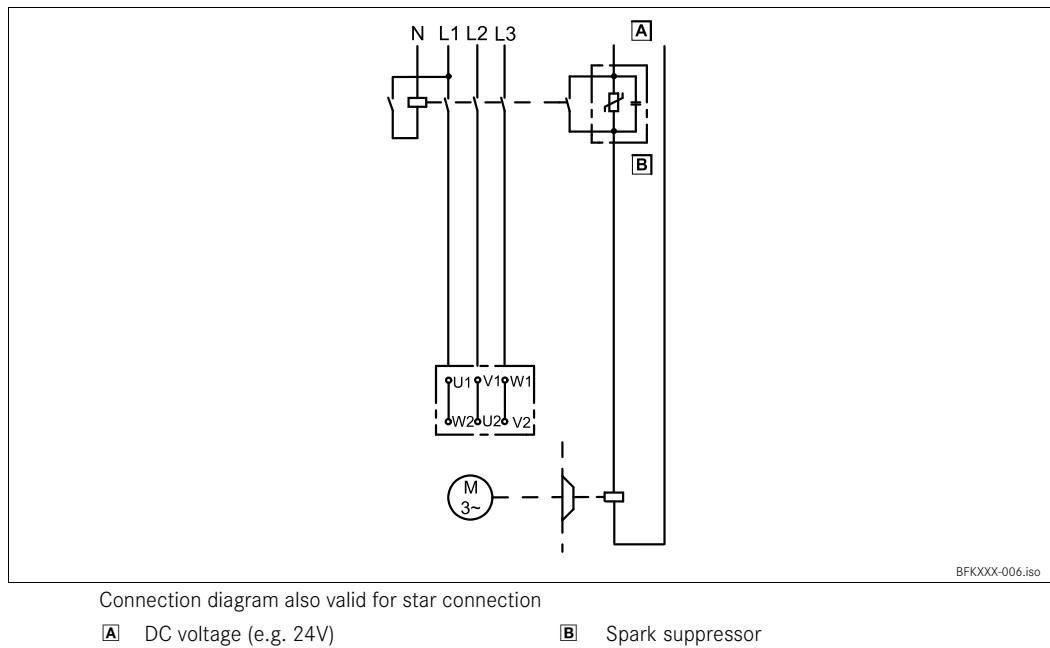



Fig. 8 Separated DC voltage (fast engagement)



Stop!

For switching on the DC side the brake must be operated with a spark suppressor to avoid impermissible overvoltages.

5 Electrical installation

1. Mount the rectifier in the terminal box. With motors of the insulation class "H", mount the rectifier in the control cabinet. Permissible ambient temperature for the rectifier -25 °C to +70 °C.
2. Compare the coil voltage of the stator to the DC voltage of the rectifier installed. Conversion of supply voltage to DC voltage:
 - Bridge rectifier: $U_{DC} = U_{AC} \cdot 0.9$
 - Half-wave rectifier: $U_{DC} = U_{AC} \cdot 0.45$
 - Permissible deviation of U_{coil} and U_{DC} up to $\pm 10\%$.
3. Select suitable circuit diagram ( 27).



Note!

Selection of the rectifier at voltages ≥ 460 V AC  catalogue "Electronic switchgear and accessories" Chapter spark suppressors and rectifiers.

4. Motor and brake must be wired according to the requirements of the engagement time.

5.2 Bridge/half-wave rectifiers (option)

BEG-561-□□□-□□□

Bridge/half-wave rectifiers are used for the supply of electromagnetic spring-applied DC brakes which have been released for operation with such rectifiers. Any other use is only permitted with the explicit written approval of INTORQ.

After a defined overexcitation time, the bridge/half-wave rectifiers change from bridge rectification to half-wave rectification. Depending on the dimensioning of the load, the switching performance can thus be improved or the power can be derated.

5 Electrical installation

5.2.1 Assignment: Bridge/half-wave rectifier - brake size

Rectifier type	AC voltage [V AC]	Coil voltage release/holding [V DC]	Assigned brake
BEG-561-255-030	230 ±10%	205 / 103	BFK457-01...16 Compact BFK457-06...16 Basic
BEG-561-255-030			
BEG-561-255-030			
BEG-561-255-030			
BEG-561-255-130			
BEG-561-255-130			
BEG-561-440-030-1	400 ±10%	360 / 180	
BEG-561-440-030-1			
BEG-561-440-030-1			
BEG-561-440-030-1			
BEG-561-440-130			
BEG-561-440-130			

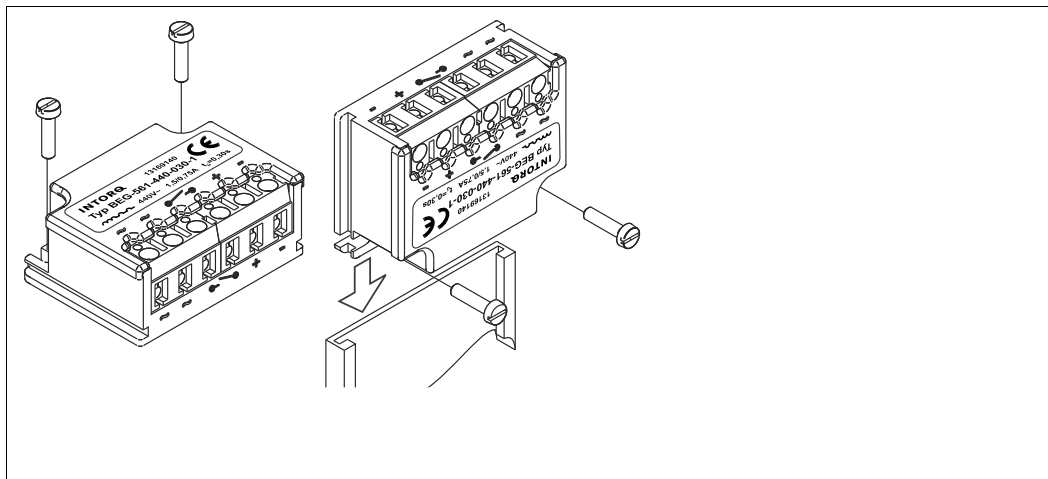

Fig. 9 BEG-561 attachment features

5.2.2 Technical data

Rectifier type	Bridge/half-wave rectifier
Output voltage for bridge rectification	0.9 x U ₁
Output voltage for half-wave rectification	0.45 x U ₁
Ambient temperature (storage/operation) [°C]	-25 ... +70

5 Electrical installation



Type	Input voltage U_1 (40 Hz ... 60 Hz)			Max. current I_{max} .		Overexcitation time t_{ue} ($\pm 20\%$)		
	min. [V ~]	rated [V ~]	max. [V ~]	bridge [A]	half-wave [A]	with U_1 min [s]	with U_1 rated [s]	with U_1 max [s]
BEG-561-255-030	160	230	255	3.0	1.5	0.430	0.300	0.270
BEG-561-255-130						1.870	1.300	1.170
BEG-561-440-030-1	230	400	440	1.5	0.75	0.500	0.300	0.270
BEG-561-440-130				3.0	1.5	2.300	1.300	1.200

Input voltage U_1 (40 ... 60 Hz)

Tab. 6 Data for bridge/half-wave rectifier type BEG-561

5.2.3 Reduced switch-off times

When switching on the DC side (fast engagement), switching on the AC side is also required! Otherwise, there will be no overexcitation during power-on.

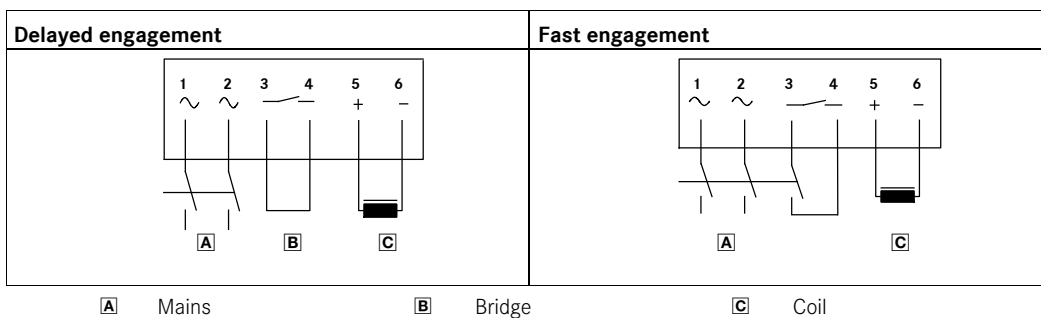

5.2.4 Permissible current load - ambient temperature

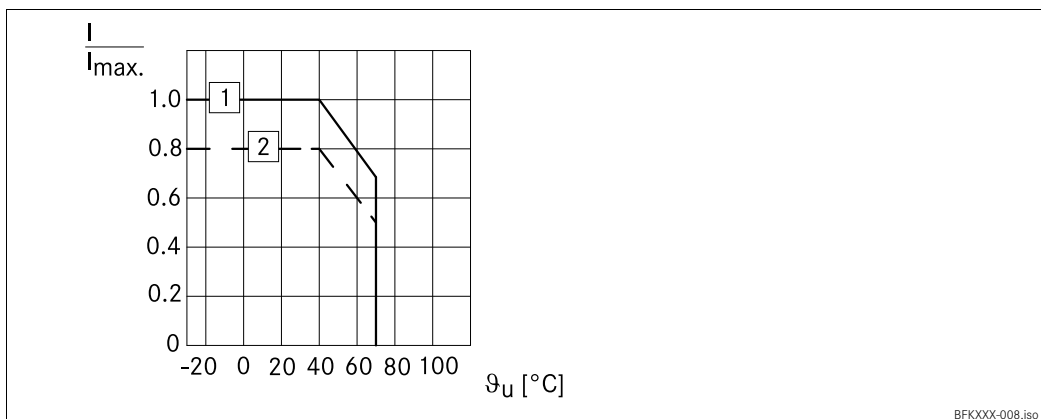

- 1 For screw assembly with metal surface (good heat dissipation)
- 2 For other assembly (e.g. glue)

6 Commissioning and operation

6.1 Important notes



Danger!

The brake must be free of residual torque.
The drive must not be running when checking the brake.



Danger!

Live connections must not be touched.

- The brakes are dimensioned in such a way that the given characteristic torques are reached safely after a short run-in process.
- Due to the fluctuating properties of the organic friction linings used and alternating environmental conditions, deviations of the given braking torques may occur. These must be considered by corresponding safety measures in the dimensioning process. Especially with humidity and alternating temperatures, an increased breakaway torque may occur after a long downtime.
- Check the braking torque if the brake is used on the customer's friction surfaces.
- If the brake is used as a pure holding brake without dynamic load, the friction lining must be reactivated regularly.

6.2 Function checks before commissioning

6.2.1 Checking the voltage

Connection diagram:  27

1. Remove two bridges from the motor terminals.
 - Do not switch off the DC brake supply.
2. The switching contact for the brake must be open.
3. Apply DC voltage to the brake.
4. Measure the AC voltage at the motor terminals. It must be zero.
5. Close the switching contact for the brake.
6. Measure the AC voltage at the motor terminals.
 - It must be the same as the mains voltage.
7. Measure the DC voltage at the brake:
 - The DC voltage measured after the overexcitation time (see bridge/half-wave rectifier) must be half the voltage indicated on the nameplate. A 10 % deviation is permissible.

6 Commissioning and operation

8. Check air gap "s_L".
 - It must be zero and the rotor must rotate freely.
9. Open the switching contact for the brake.
10. Screw the bridges onto the motor terminals.

6.2.2 Release / Release control



Danger!

The brake must be free of residual torque. The motor must not rotate.



Danger!

Live connections must not be touched.

1. Remove two bridges from the motor terminals. Do **not** switch off the DC brake supply. When connecting the rectifier to the neutral point of the motor, the PE conductor must **also** be connected to this point.
2. Connect the mains supply.
3. Measure the DC voltage at the brake.
 - Compare the DC voltage measured with the voltage specified on the nameplate. A 10 % deviation is permissible.
4. Check air gap "s_L". It must be zero and the rotor must rotate freely.
5. Switch off the current.
6. Bolt bridges to the motor terminals. Remove additional PEN conductor.

The preparations for commissioning are completed.

In the event of failures, refer to the troubleshooting table,  43. If the fault cannot be eliminated, please contact the aftersales service.

6.3 Commissioning

1. Switch on drive system.
2. Carry out a braking test.

6 Commissioning and operation

6.4 During operation



Danger!

Live connections must not be touched.

- Check the brake regularly during operation. Take special care of:
 - unusual noises or temperatures
 - loose fixing elements
 - the condition of the electrical cables.
- The armature plate must be attracted and the drive must move without residual torque.
- Measure the DC voltage at the brake.
 - Compare the DC voltage measured with the voltage specified on the nameplate. A $\pm 10\%$ deviation is permissible.

7 Maintenance/repair

7.1 Wear of spring-applied brakes

The following table describes the different causes of wear and their effects on the components of the spring-applied brake. The important influencing factors must be quantified so that the service life of the rotor and brake can be calculated and that the maintenance intervals to be prescribed can be specified precisely. The most important factors in this context are the applied friction energy, the initial speed of braking and the operating frequency. If several of the causes of friction lining wear occur in an application at the same time, the influencing factors are to be added together when the amount of wear is calculated.

Component	Cause	Effect	Influencing factors
Friction lining	Braking during operation	Wear of friction lining	Friction work
	Emergency stops		
	Overlapping wear during start and stop of drive		Number of start/stop cycles
	Active braking via the drive motor with support of brake (quick stop)		
	Starting wear in case of motor mounting position with vertical shaft, even when the brake is not applied		
Armature plate and counter friction face	Rubbing of brake lining	Run-in of armature plate and counter friction face	Friction work
Splining of brake rotor	Relative movements and shocks between brake rotor and brake shaft	Wear of splining (primarily on the rotor side)	Number of start/stop cycles
Brake support	Load alternation and jerks in the backlash between armature plate, sleeve bolts and guide bolt	Breaking of armature plate, sleeve bolts and guide bolt	Number of start/stop cycles, braking torque
Springs	Axial load cycle and shear stress of springs through radial backlash on reversal of armature plate	Reduced spring force or fatigue failure	Number of switching operations of brake

Tab. 7 Causes for wear

7 Maintenance/repair

7.2 Inspections

7.2.1 Important notes

To ensure safe and trouble-free operation, spring-applied brakes must be checked and maintained at regular intervals. Servicing can be made easier if good accessibility of the brakes is provided in the plant. This must be considered when installing the drives in the plant.

Primarily, the necessary maintenance intervals for industrial brakes result from the load during operation. When calculating the maintenance interval, all causes for wear must be taken into account, [35]. For brakes with low loads such as holding brakes with emergency stop, we recommend a regular inspection at a fixed time interval. To reduce the cost, the inspection can be carried out along with other regular maintenance work in the plant if necessary.

If the brakes are not maintained, failures, production losses or damage to the system may occur. Therefore, a maintenance concept adapted to the particular operating conditions and brake loads must be defined for every application. For the spring-applied brakes, the maintenance intervals and maintenance operations listed in the below table must be provided. The maintenance operations must be carried out as described in the detailed descriptions.

7.2.2 Maintenance intervals

Time interval	for service brakes:	for holding brakes with emergency stop:
	<ul style="list-style-type: none"> ■ according to service life calculation ■ otherwise every six months ■ after 4000 operating hours at the latest 	<ul style="list-style-type: none"> ■ at least every 2 years ■ after 1 million cycles at the latest

7 Maintenance/repair

7.3 Maintenance operations



Note!

Brakes with defective armature plates, springs or flanges must completely be replaced.

In general, the following must be observed when carrying out any inspection or maintenance work:

- Remove impurities through oil and grease using brake cleaning agents, if necessary, replace brake after identifying the cause of the contamination. Dirt deposits in the air gap between stator and armature plate impair the function of the brake and must be removed.
- After the replacement of the rotor, the initial braking torque will not be reached until the friction surfaces are run in. After the replacement of the rotor, the run-in armature plates and flanges have a higher initial rate of wear. In this case, the air gap must be adjusted betimes if necessary.

Inspections with assembled brake	■ Check release function and control	📖 38
	■ Measure air gap (if necessary, replace rotor / brake)	📖 39 / 38
	■ Thermal damage of armature plate or flange (dark-blue tarnishing)	
Inspections after removing the brake	■ Check clearance of the rotor toothing (replace worn-out rotors)	📖 39
	■ Wear-out of the torque support at sleeve bolts and armature plate	
	■ Check springs for damage	
	■ Check armature plate and flange/end shield <ul style="list-style-type: none"> - Evenness size 06...12 < 0.06 mm - Evenness size 14 + 16 < 0.1 mm - Max. run-in depth = rated air gap of the size 	

7.3.1 Air gap



Danger!

The motor must not be running when checking the air gap.



Danger!

The motor must not be running when checking the air gap.

1. Measure the air gap "s_L" between armature plate and rotor using a feeler gauge (values 📖 15).
2. Compare the measured air gap with the maximally permissible air gap "s_{Lmax}." (values 📖 15).
3. If necessary, replace rotor (only for basic version BFK457-06...16) or replace complete brake (only for compact version BFK457-01...16).

7 Maintenance/repair

7.3.2 Release / voltage



Danger!

The running rotor must not be touched.



Danger!

Live connections must not be touched.

1. Observe the brake function during operation of the drive. The armature plate must be attracted and the rotor must move without residual torque.
2. Measure the DC voltage at the brake.
 - The DC voltage measured after the overexcitation time (see bridge/half-wave rectifier) must be half the voltage indicated on the nameplate. A 10 % deviation is permissible.



7.3.3 Brake replacement

Compact version



Danger!

The brake must be free of residual torque.

1. Disconnect the connection cable.
2. Unbolt fixing screws and remove brake from endshield. Observe connection cable.
3. Pull brake from hub.
4. Check hub tothing. In case of wear disassemble and replace hub.
5. Check brake function according to maintenance description  36.
6. If necessary, install new brake.
7. Reconnect the connection cable.
8. Recommission the brake,  32.

7 Maintenance/repair

7.3.4 Rotor replacement

Basic version



Danger!

Disconnect voltage. The brake must be free of residual load torque.

1. Disconnect the connection cable.





Stop!

Die Bremse zerfällt in Einzelteile!

Vor der Demontage der Bremse müssen die Zylinderschrauben (10.1)  25 in das Magnetteil bzw. die Ankerscheibe eingeschraubt werden. Dadurch werden die Federn und Schrauben in der Baugruppe "Magnetteil komplett" zusammengehalten.

Type	Size of cheese head screw pos. 10.1
BFK457-06	2 x M4 x 30
BFK457-08	2 x M5 x 35
BFK457-10	2 x M5 x 40
BFK457-12	2 x M5 x 45
BFK457-14	2 x M6 x 60
BFK457-16	2 x M6 x 60

2. Unbolt fixing screws and remove brake from endshield. Observe connection cable.
3. Pull rotor from hub.
4. Check hub toothing. In case of wear disassemble and replace hub.
5. Check friction surfaces.
 - In case of strong scoring at the flange, replace the flange.
 - In case of strong scoring at the end shield, rework the friction surface.
6. Measure the rotor thickness using a caliper gauger and compare with the values stated in chapter 3.2. If necessary, replace rotor.
7. Check brake function,  36.
8. If necessary, install new brake.
9. Reconnect the connection cable.
10. Recommission the brake,  32.

7 Maintenance/repair



Note!

After replacing the rotor, the original braking torque will not be reached until the run-in operation of the friction surfaces has been completed. After replacing the rotor, run-in armature plates and flanges have an increased initial rate of wear.

7.4 Spare-parts list

- Only parts with item numbers are available.
 - The item numbers are only valid for the standard design.
- Please include the following information with the order:
 - Order number of the brake
 - Position number of the spare part

Compact version



Note!

If the wear limit 15 has been reached, the complete brake has to be replaced in case of the compact version.

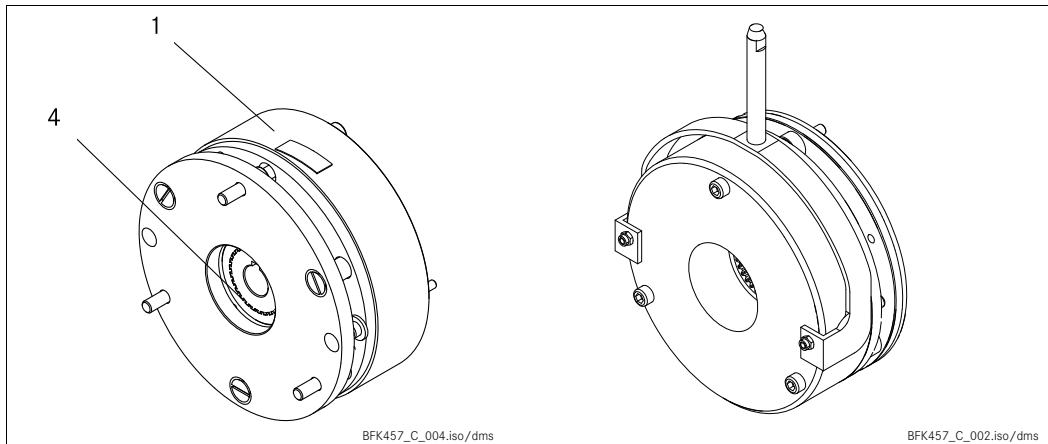

Item	Designation	Variant		
		Size	Voltage	Brake torque
1	Spring-applied brake	Size	Voltage	Brake torque
4	Hub	Size	—	—

7 Maintenance/repair



Basic version

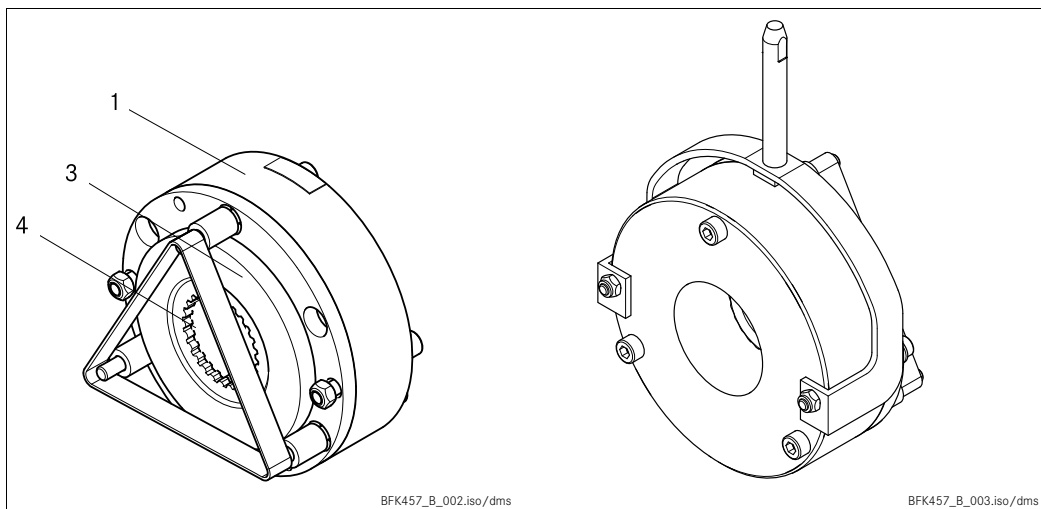

Item	Designation	Variant		
		Size	Voltage	Brake torque
1	Spring-applied brake	Size	Voltage	Brake torque
3	Rotor	Size	—	—
4	Hub	Size	—	—

7 Maintenance/repair

7.5 Spare parts order

Spring-applied brake BFK457-□□

Identification _____ Order number the brake (see nameplate)

Version **Compact** completely mounted with rotor and flange
 Compact completely mounted with manual release

Size 01 02 03 04 05
 06 08 10 12 14 16

Voltage 24 V 205 V 42 V (size 14 and 16)

Hub _____ mm (for bore diameter, see dimensions)

Version **Basic** stator completely mounted with rotor
 Basic stator completely mounted with manual release

Size 06 08 10 12 14 16

Voltage 24 V 205 V 42 V (size 14 and 16)



Rotor low-noise version

Hub _____ mm (for bore diameter, see dimensions)

Size		01	02	03	04	05	06	08	10	12	14	16
Brake torque [Nm]	<input type="checkbox"/>	0.12	0.25	0.5	1	2	4	8	16	32	60	80
	<input type="checkbox"/>	0.25	0.5	1	2	4	6	12	23	46	90	125

8 Troubleshooting and fault elimination

If any malfunctions should occur during operation, please check the possible causes using the following table. If the fault cannot be eliminated by one of the listed measures, please contact the aftersales service.

Fault	Cause	Remedy
Spring-applied brake cannot be released, air gap is not zero	Coil interruption	<ul style="list-style-type: none"> ■ Measure coil resistance using a multimeter: <ul style="list-style-type: none"> - If the resistance is too high, replace the spring-applied brake.
	Coil has interturn fault or short circuit to ground	<ul style="list-style-type: none"> ■ Measure coil resistance using a multimeter: <ul style="list-style-type: none"> - Compare the measured resistance with the rated resistance. Values  15, characteristics. If the resistance is too low, replace the spring-applied brake. ■ Check coil for short circuit to ground using a multimeter: <ul style="list-style-type: none"> - In case of short circuit to ground replace the spring-applied brake. ■ Check brake voltage (see "defective rectifier, voltage too low").
	Defective or incorrect wiring	<ul style="list-style-type: none"> ■ Check and correct wiring. ■ Check cable continuity using a multimeter: <ul style="list-style-type: none"> - Replace defective cable.
	Defective or incorrect rectifier	<ul style="list-style-type: none"> ■ Measure rectifier DC voltage using a multimeter. If DC voltage is zero: <ul style="list-style-type: none"> ■ Check AC rectifier voltage. If AC voltage is zero: <ul style="list-style-type: none"> - Switch on power supply, - check fusing, - check wiring. If AC voltage is ok: <ul style="list-style-type: none"> - Check rectifier - Replace defective rectifier If DC voltage is too low: <ul style="list-style-type: none"> - Check rectifier - Half-wave rectifier used instead of bridge rectifier - install bridge rectifier. - Diode defective - install an appropriate undamaged rectifier. ■ Check coil for interturn fault or short circuit to ground. ■ If the rectifier defect occurs again, replace the spring-applied brake even if you cannot measure an interturn fault or short circuit to ground. The fault may only occur when warm.
	Air gap too large	<ul style="list-style-type: none"> ■ Spring-applied brake INTORQ BFK457-01...16, replace rotor.
Rotor not thick enough	Spring-applied brake not replaced in time	Replace spring-applied brake,  23 and  24
Voltage too high	Brake voltage does not match with rectifier	Adapt the rectifier to the brake voltage or the brake voltage to the rectifier.
Voltage too low	Brake voltage does not match with rectifier	Adapt the rectifier to the brake voltage or the brake voltage to the rectifier.
	Defective rectifier diode	Replace defective rectifier by a suitable undamaged one.
AC voltage is not mains voltage	Fuse missing or defective	Select a connection with proper fusing.