



TCF Series

Installation and Operation Manual

Table of Contents

1	GENERAL	1
1.1	PRODUCTS COVERED IN THIS MANUAL	1
1.2	PRODUCT CHANGES	1
1.3	WARRANTY	1
1.4	RECEIVING	1
1.5	SAFETY INFORMATION	1
1.6	CUSTOMER MODIFICATION	2
2	TCF DIMENSIONS	3
3	TCF MODEL DESIGNATION CODE	5
4	TCF SPECIFICATIONS	6
5	TCF RATINGS	7
6	INSTALLATION	9
6.1	INSTALLATION AFTER A LONG PERIOD OF STORAGE	10
6.2	EXPLOSION PROOF APPLICATIONS	10
7	INPUT AC POWER REQUIREMENTS	11
7.1	INPUT VOLTAGE RATINGS	11
7.2	INPUT FUSING & DISCONNECT REQUIREMENTS	12
7.3	INPUT WIRE SIZE REQUIREMENTS	13
7.4	INSTALLATION ACCORDING TO EMC REQUIREMENTS	13
8	POWER WIRING	14
8.1	WIRING FOR SINGLE PHASE OR THREE PHASE INPUT	14
9	TCF POWER WIRING DIAGRAM	15
10	CONTROL WIRING	16
10.1	CONTROL WIRING VS. POWER WIRING	16
10.2	TB-2 AND TB-4	16
10.3	SURGE SUPPRESSION ON RELAYS	16
10.4	START/STOP CONTROL	16
10.5	SPEED/TORQUE REFERENCE SIGNALS	17
10.6	SPEED REFERENCE SELECTION	17
10.7	ANALOG OUTPUT SIGNALS	19
10.8	DRIVE STATUS DIGITAL OUTPUTS	19
11	TCF CONTROL WIRING DIAGRAMS	20
11.1	TCF TERMINAL STRIP	20
11.2	TWO-WIRE START/STOP CONTROL	21
11.3	ALTERNATE TWO-WIRE START/STOP CONTROL	22
11.4	THREE-WIRE START/STOP CONTROL	23
11.5	SPEED POT AND PRESET SPEED CONTROL	24
11.6	BIPOLAR SPEED CONTROL (-10 to +10 VDC)	25
12	INITIAL POWER UP AND MOTOR ROTATION	26
13	PROGRAMMING THE TCF DRIVE	28
13.1	ELECTRONIC PROGRAMMING MODULE (EPM)	29
13.2	TCF DRIVE PERSONALITY	31
14	PARAMETER MENU	32
15	DESCRIPTION OF PARAMETERS	36
16	TROUBLESHOOTING	57
17	TCF DISPLAY MESSAGES	59
17.1	SPEED/TORQUE DISPLAY	59
17.2	CHANGING THE SPEED REFERENCE SOURCE	60
17.3	STATUS AND WARNING MESSAGES	61
A	APPENDIX - VECTOR MODE	62
B	APPENDIX - INPUT ASSERTION LEVEL	64

TCF Sub-Micro Drive

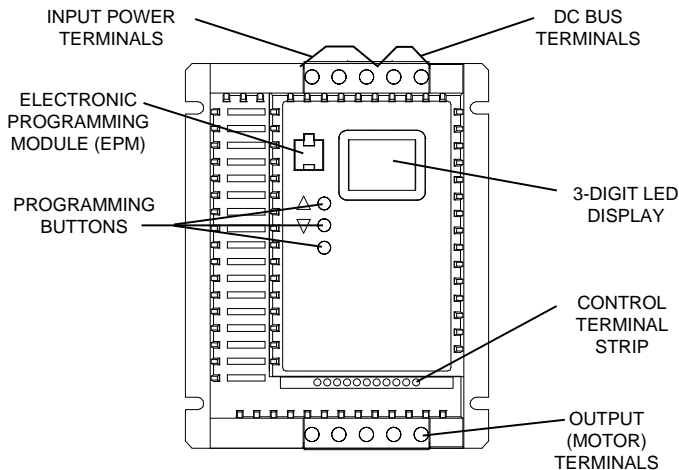





Safety Information

All safety information given in these Operating Instruction have the same layout:



Signal Word! (Characterizes the severity of the danger)

Note (describes the danger and informs on how to proceed)

Icon	Signal Words
 Warning of hazardous electrical voltage	DANGER! Warns of impending danger . Consequences if disregarded: Death or severe injuries.
 Warning of a general danger	WARNING! Warns of potential, very hazardous situations . Consequences if disregarded: Death or severe injuries.
 Warning of damage to equipment	STOP! Warns of potential damage to material and equipment . Consequences if disregarded: Damage to the controller/drive or its environment.
 Information	Note Designates a general, useful note. If you observe it, handling the controller/drive system is made easier.

1 GENERAL

1.1 PRODUCTS COVERED IN THIS MANUAL

This manual covers the Lenze AC Tech TCF Series Variable Frequency Drive.

1.2 PRODUCT CHANGES

Lenze AC Tech Corporation reserves the right to discontinue or make modifications to the design of its products without prior notice, and holds no obligation to make modifications to products sold previously. Lenze AC Tech also holds no liability for losses of any kind which may result from this action. Instruction manuals with the most up-to-date information are available for download from the Lenze AC Tech web site.

1.3 WARRANTY

Lenze AC Tech Corporation warrants the TCF Series AC motor control to be free of defects in material and workmanship for a period of 24 months from the date of shipment from Lenze AC Tech's factory. If a TCF motor control, under normal use, becomes defective within the stated warranty time period, contact Lenze AC Tech's Service Department for instructions on obtaining a warranty replacement unit. Lenze AC Tech reserves the right to make the final determination as to the validity of a warranty claim, and sole obligation is to repair or replace only components which have been rendered defective due to faulty material or workmanship. No warranty claim will be accepted for components which have been damaged due to mishandling, improper installation, unauthorized repair and/or alteration of the product, operation in excess of design specifications or other misuse, or improper maintenance. Lenze AC Tech makes no warranty that its products are compatible with any other equipment, or to any specific application, to which they may be applied and shall not be held liable for any other consequential damage or injury arising from the use of its products.

This warranty is in lieu of all other warranties, expressed or implied. No other person, firm or corporation is authorized to assume, for Lenze AC Tech, any other liability in connection with the demonstration or sale of its products.

1.4 RECEIVING

Inspect all cartons for damage which may have occurred during shipping. Carefully unpack equipment and inspect thoroughly for damage or shortage. Report any damage to carrier and/or shortages to supplier. All major components and connections should be examined for damage and tightness, with special attention given to PC boards, plugs, knobs and switches.

1.5 SAFETY INFORMATION

GENERAL

Some parts of Lenze AC Tech controllers can be electrically live and some surfaces can be hot. Non-authorized removal of the required cover, inappropriate use, and incorrect installation or operation creates the risk of severe injury to personnel or damage to equipment.

All operations concerning transport, installation, and commissioning as well as maintenance must be carried out by qualified, skilled personnel who are familiar with the installation, assembly, commissioning, and operation of variable frequency drives and the application for which it is being used.

INSTALLATION

Ensure proper handling and avoid excessive mechanical stress. Do not bend any components and do not change any insulation distances during transport, handling, installation or maintenance. Do not touch any electronic components or contacts. This drive contains electrostatically sensitive components, which can easily be damaged by inappropriate handling. Static control precautions must be adhered to during installation, testing, servicing and repairing of this drive and associated options. Component damage may result if proper procedures are not followed.

This drive has been tested by Underwriters Laboratory (UL) and is an approved component in compliance with UL508 Safety Standard.



Warnings!

- Suitable for use on a circuit as described in Section 7.0 of this manual.
- Use minimum 75 °C copper wire only.
- Shall be installed in a pollution degree 2 macro-environment.

This drive must be installed and configured in accordance with both national and international standards. Local codes and regulations take precedence over recommendations provided in this and other Lenze AC Tech documentation.

The TCF drive is considered a component for integration into a machine or process. It is neither a machine nor a device ready for use in accordance with European directives (reference machinery directive and electromagnetic compatibility directive). It is the responsibility of the end user to ensure that the machine meets the applicable standards.

ELECTRICAL CONNECTION

When working on live drive controllers, applicable national safety regulations must be observed.

The electrical installation must be carried out according to the appropriate regulations (e.g. cable cross-sections, fuses, protective earth [PE] connection). While this document does make recommendations in regards to these items, national and local codes must be adhered to.

The documentation contains information about installation in compliance with EMC (shielding, grounding, filters and cables). These notes must also be observed for CE-marked controllers. The manufacturer of the system or machine is responsible for compliance with the required limit values demanded by EMC legislation.

APPLICATION

The drive must not be used as a safety device for machines where there is a risk of personal injury or material damage. Emergency Stops, over-speed protection, acceleration and deceleration limits, etc must be made by other devices to ensure operation under all conditions.

The drive does feature many protection devices which are aimed at protecting the drive and the driven equipment by generating a fault and shutting the drive and motor down by removing power. Mains power variances can also result in shutdown of the drive. When the fault condition disappears or is cleared, the drive can be configured to automatically restart, it is the responsibility of the user and/or OEM and/or integrator to ensure that the drive is configured for safe operation.

1.6 CUSTOMER MODIFICATION

Lenze AC Tech, its sales representatives and distributors, welcome the opportunity to assist our customers in applying our products. Many customizing options are available to aid in this function. Lenze AC Tech cannot assume responsibility for any modifications not authorized by its engineering department.

2 TCF DIMENSIONS

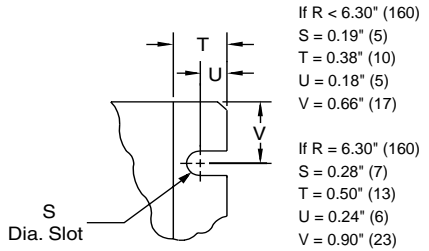
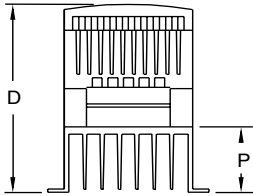
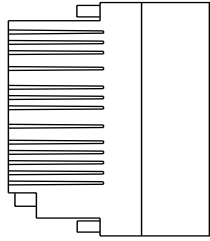
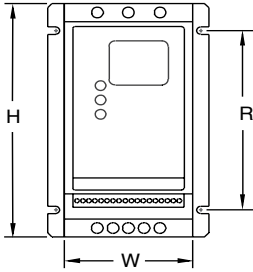

Mounting Tab Detail

HP	kW	INPUT VOLTAGE	MODEL	H	W	D	P	R
0.5	0.37	208 / 240	TF205Y	5.75 (146)	2.88 (73)	3.94 (100)	0.80 (20)	4.37 (111)
		400 / 480	TF405	5.75 (146)	3.76 (96)	5.24 (133)	1.90 (48)	4.37 (111)
1	0.75	208 / 240	TF210Y	5.75 (146)	2.88 (73)	4.74 (120)	1.60 (41)	4.37 (111)
		208 / 240	TF210	5.75 (146)	2.88 (73)	4.74 (120)	1.60 (41)	4.37 (111)
		400 / 480	TF410	5.75 (146)	3.76 (96)	5.24 (133)	1.90 (48)	4.37 (111)
		480 / 590	TF510	5.75 (146)	3.76 (96)	5.24 (133)	1.90 (48)	4.37 (111)
1.5	1.1	208 / 240	TF215Y	5.75 (146)	3.76 (96)	5.24 (133)	1.90 (48)	4.37 (111)
		208 / 240	TF215	5.75 (146)	2.88 (73)	5.74 (146)	2.60 (66)	4.37 (111)
		400 / 480	TF415	5.75 (146)	3.76 (96)	5.24 (133)	1.90 (48)	4.37 (111)
2	1.5	208 / 240	TF220Y	5.75 (146)	3.76 (96)	6.74 (171)	3.40 (86)	4.37 (111)
		208 / 240	TF220	5.75 (146)	3.76 (96)	6.74 (171)	3.40 (86)	4.37 (111)
		400 / 480	TF420	5.75 (146)	3.76 (96)	6.74 (171)	3.40 (86)	4.37 (111)
		480 / 590	TF520	5.75 (146)	3.76 (96)	6.74 (171)	3.40 (86)	4.37 (111)
3	2.2	208 / 240	TF230Y	5.75 (146)	3.76 (96)	6.74 (171)	3.40 (86)	3.25 (83)
		208 / 240	TF230	5.75 (146)	3.76 (96)	6.74 (171)	3.40 (86)	3.25 (83)
		400 / 480	TF430	5.75 (146)	3.76 (96)	6.74 (171)	3.40 (86)	3.25 (83)
		480 / 590	TF530	5.75 (146)	3.76 (96)	6.74 (171)	3.40 (86)	3.25 (83)
5	4.0	208 / 240	TF250	5.75 (146)	3.76 (96)	6.74 (171)	3.40 (86)	3.25 (83)
		400 / 480	TF450	5.75 (146)	3.76 (96)	6.74 (171)	3.40 (86)	3.25 (83)
		480 / 590	TF550	5.75 (146)	3.76 (96)	6.74 (171)	3.40 (86)	3.25 (83)
7.5	5.5	208 / 240	TF275	7.75 (197)	5.02 (128)	7.18 (182)	3.40 (86)	4.81 (122)
		400 / 480	TF475	7.75 (197)	5.02 (128)	7.18 (182)	3.40 (86)	4.81 (122)
		480 / 590	TF575	7.75 (197)	5.02 (128)	7.18 (182)	3.40 (86)	4.81 (122)
10	7.5	208 / 240	TF2100	7.75 (197)	5.02 (128)	7.18 (182)	3.40 (86)	4.81 (122)
		400 / 480	TF4100	7.75 (197)	5.02 (128)	7.18 (182)	3.40 (86)	4.81 (122)
		480 / 590	TF5100	7.75 (197)	5.02 (128)	7.18 (182)	3.40 (86)	4.81 (122)

3 TCF MODEL DESIGNATION CODE

The TCF model number gives a full description of the basic drive unit.

EXAMPLE: **TF210Y** = TCF Series, 208/240 Vac, 1 HP, single or three phase input

	TF	2	10	Y
Series:				
TF = TCF Series Sensor less Vector Variable Speed AC Motor Drive				
Input Voltage:				
2 = 208/240 Vac (For 208, 230, and 240 Vac; 50 or 60 Hz)				
4 = 400/480 Vac (For 380, 415, 440, 460 and 480 Vac; 50 or 60 Hz)				
5 = 480/590 Vac (For 440, 460, 480, 575 and 600 Vac; 50 or 60 Hz)				
Rating:				
05 = ½ HP (0.37 kW)		30 = 3 HP (2.2 kW)		
10 = 1 HP (0.75 kW)		50 = 5 HP (4.0 kW)		
15 = 1½ HP (1.1 kW)		75 = 7½ HP (5.5 kW)		
20 = 2 HP (1.5 kW)		100 = 10 HP (7.5 kW)		
Input Phase:				
Y = Single or three phase input.				
<i>No character indicates three phase input only</i>				

4 TCF SPECIFICATIONS

Specification	Range
Storage Temperature	-20° to 70° C
Ambient Operating Temperature	0° to 50° C (derate 2.5% per °C above 50°)
Ambient Humidity	< 95% (non-condensing)
Maximum Altitude	3300 ft. (1000 m) above sea level (derate 5% per additional 3300 ft.)
Input Line Voltages	208/240 Vac, 400/480 Vac, 480/590 Vac
Input Voltage Tolerance	+10%, -15%
Input Frequency Tolerance	48 to 62 Hz
Output Wave Form	Sine Coded PWM
Output Frequency	0 - 240 Hz (consult factory for higher output frequencies)
Carrier Frequency	2 kHz, 4 kHz, 8 kHz (8 kHz requires derating; see parameter P02)
Service Factor	1.00 (up to 4 kHz carrier; derate for 8 kHz; see parameter P02)
Efficiency	Up to 98%
Power Factor (displacement)	0.96 or better
Overload Current Capacity	150% for 60 seconds, 200% for 25 seconds
Speed Reference Follower	0-10 VDC, 4-20 mA
Control Voltage	15 VDC
Power Supply for Auxiliary Relays	50 mA at 12 VDC
Analog Output	0 - 10 VDC or 2 - 10 VDC: Proportional to speed, load, or torque
Digital Outputs	Open-collector outputs: 50 mA at 30 VDC
Earth Leakage Current	< 3.5 mA to earth ground

5 TCF RATINGS

MODEL NUMBER (NOTE 1)	FOR MOTORS RATED		INPUT (50-60 Hz)			OUTPUT	HEAT LOSS (WATTS) (NOTE 5)
			INPUT PHASE	CURRENT (AMPS)	POWER (kVA)	CURRENT (AMPS)	
	HP	kW					
TF200Y SERIES (NOTE 2)			208 / 240 Vac			0 - 200 / 230 Vac	
TF205Y	0.5	0.37	1	5.4 / 4.7	1.2	2.5 / 2.2	26
TF205Y	0.5	0.37	3	3.1 / 2.7	1.1	2.5 / 2.2	26
TF210Y	1	0.75	1	10.6 / 9.2	2.2	4.8 / 4.2	49
TF210Y	1	0.75	3	5.8 / 5.1	2.1	4.8 / 4.2	49
TF215Y	1.5	1.1	1	13.9 / 12.0	2.9	6.9 / 6.0	82
TF215Y	1.5	1.1	3	8.0 / 6.9	2.9	6.9 / 6.0	82
TF220Y	2	1.5	1	14.8 / 12.9	3.1	7.8 / 6.8	86
TF220Y	2	1.5	3	9.1 / 7.9	3.2	7.8 / 6.8	86
TF230Y	3	2.2	1	19.7 / 17.1	4.1	11.0 / 9.6	130
TF230Y	3	2.2	3	12.4 / 10.8	4.4	11.0 / 9.6	130
TF200 SERIES (NOTE 2)			208 / 240 Vac			0 - 200 / 230 Vac	
TF210	1	0.75	3	5.8 / 5.1	2.1	4.8 / 4.2	41
TF215	1.5	1.1	3	8.0 / 6.9	2.9	6.9 / 6.0	69
TF220	2	1.5	3	9.1 / 7.9	3.3	7.8 / 6.8	78
TF230	3	2.2	3	12.4 / 10.8	4.5	11.0 / 9.6	117
TF250	5	4.0	3	19.6 / 17.1	7.1	17.5 / 15.2	187
TF275	7.5	5.5	3	28 / 25	10.3	25 / 22	286
TF2100	10	7.5	3	34 / 32	13.1	30 / 28	379

NOTE 1: Refer to Section 3 for model number breakdown.

NOTE 2: The higher current ratings are for 208 Vac input and the lower current ratings are for 240 Vac input.

NOTE 5: Values are worst-case (not typical) for 4kHz carrier frequency at full speed and full load.

MODEL NUMBER (NOTE 1)	FOR MOTORS RATED		INPUT (50-60 Hz)			OUTPUT	HEAT LOSS (WATTS) (NOTE 5)
			INPUT PHASE	CURRENT (AMPS)	POWER (kVA)	CURRENT (AMPS)	
	HP	kW					
TF400 SERIES (NOTE 3)			400 / 480 Vac			0 - 400 / 460 Vac	
TF405	0.5	0.37	3	1.6 / 1.4	1.1	1.3 / 1.1	26
TF410	1	0.75	3	2.9 / 2.5	2.1	2.4 / 2.1	40
TF415	1.5	1.1	3	4.0 / 3.6	3.0	3.4 / 3.0	56
TF420	2	1.5	3	4.6 / 4.0	3.3	3.9 / 3.4	67
TF430	3	2.2	3	6.2 / 5.4	4.5	5.5 / 4.8	100
TF450	5	4.0	3	10.6 / 8.8	7.1	9.4 / 7.8	168
TF475	7.5	5.5	3	14.2 / 12.4	10.3	12.6 / 11.0	254
TF4100	10	7.5	3	18.1 / 15.8	13.1	16.1 / 14.0	310
TF500 SERIES (NOTE 4)			480 / 590 Vac			0 - 460 / 575 Vac	
TF510	1	0.75	3	2.2 / 2.0	1.9 / 2.0	1.9 / 1.7	40
TF520	2	1.5	3	4.0 / 3.5	3.3 / 3.6	3.4 / 3.0	67
TF530	3	2.2	3	4.7 / 4.7	3.9 / 4.8	4.2 / 4.2	100
TF550	5	3.7	3	7.4 / 7.4	6.1 / 7.5	6.6 / 6.6	168
TF575	7.5	5.5	3	11.2 / 11.2	9.3 / 11.4	9.9 / 9.9	254
TF5100	10	7.5	3	13.7 / 13.7	11.4 / 14.0	12.2 / 12.2	310

NOTE 1: Refer to Section 3 for model number breakdown.

NOTE 3: The higher current ratings are for 400 Vac input and the lower current ratings are for 480 Vac input.

NOTE 4: The higher current ratings are for 480 Vac input and the lower current ratings are for 590 Vac input.

NOTE 5: Values are worst-case (not typical) for 4kHz carrier frequency at full speed and full load

6 INSTALLATION



NOTE

TCF Series drives are intended for inclusion within other equipment, by professional electrical installers according to EN 61000-3-2. The TCF drive is not intended for stand-alone operation



WARNING!

Drives must **NOT** be installed where subjected to adverse environmental conditions such as: combustible, oily, or hazardous vapors or dust; excessive moisture or dirt; vibration; excessive ambient temperatures. Consult Lenze-AC Tech for more information on the suitability of a drive to a particular environment.

TCF models are suitable for UL pollution degree 2 environment only, and **MUST** be installed in an electrical enclosure which will provide complete mechanical protection and will maintain the internal temperature within the drive's ambient operating temperature rating. All drive models **MUST** be mounted in a vertical position for proper heatsink cooling.

Maintain a minimum spacing around the drive of at least 1 inch (25 mm) on each side and 2 inches (50 mm) on the top and bottom for units rated up to 5 HP (3.7 kW). For units rated 7.5 - 10 HP (5.5 - 7.5 kW), maintain at least 2 inches (50 mm) on each side and 4 inches (100 mm) on the top and bottom. Allow more spacing if the drive is mounted next to other heat-producing equipment. Do not mount drives above other drives or heat producing equipment. Fans or blowers should be used to insure proper cooling in tight quarters.

In order to properly size an enclosure, the heat generated by the drive(s) must be known. Refer to the HEAT LOSS column in Section 5 - TCF RATINGS. An enclosure manufacturer can then determine the required enclosure size based on the total heat generated inside the enclosure (from the drive(s) and other heat sources), the maximum allowable temperature inside the enclosure, the maximum ambient temperature outside the enclosure, and the enclosure properties.

The TCF Series is UL approved for solid state motor overload protection. Therefore, a separate thermal overload relay is not required for single motor applications.

6.1 INSTALLATION AFTER A LONG PERIOD OF STORAGE



STOP!

Severe damage to the drive can result if it is operated after a long period of storage or inactivity without reforming the DC bus capacitors!

If input power has not been applied to the drive for a period of time exceeding three years (due to storage, etc), the electrolytic DC bus capacitors within the drive can change internally, resulting in excessive leakage current. This can result in premature failure of the capacitors if the drive is operated after such a long period of inactivity or storage.

In order to reform the capacitors and prepare the drive for operation after a long period of inactivity, apply input power to the drive for 8 hours prior to actually operating the motor.

6.2 EXPLOSION PROOF APPLICATIONS

Explosion proof motors that are not rated for inverter use lose their certification when used for variable speed. Due to the many areas of liability that may be encountered when dealing with these applications, the following statement of policy applies:

“Lenze AC Tech inverter products are sold with no warranty of fitness for a particular purpose or warranty of suitability for use with explosion proof motors. Lenze AC Tech accepts no responsibility for any direct, incidental or consequential loss, cost, or damage that may arise through the use of its AC inverter products in these applications. The purchaser expressly agrees to assume all risk of any loss, cost, or damage that may arise from such application.”

7 INPUT AC POWER REQUIREMENTS



DANGER!

Hazard of electrical shock! Capacitors retain charge after they've been removed. Disconnect incoming power and wait until the voltage between terminals B+ and B- is 0 VDC before servicing the drive.

The input voltage must match the nameplate voltage rating of the drive. Voltage fluctuation must not vary by greater than 10% over voltage or 15% under voltage.



NOTE

Drives with dual input voltage ratings must be programmed for the proper supply voltage (refer to Parameter 01 - LINE VOLTAGE SELECTION in Section 15 - DESCRIPTION OF PARAMETERS).

The drive is suitable for use on a circuit capable of delivering not more than 5,000 RMS symmetrical amperes at 5 HP (4.0 kW) and below, and 18,000 RMS symmetrical amperes at 7.5 - 10 HP (5.5 - 7.5 kW), at the drive's rated voltage.

If the kVA rating of the AC supply transformer is greater than 10 times the input kVA rating of the drive(s), an isolation transformer or 2-3% input line reactor must be added to the line side of the drive(s).

Three phase voltage imbalance must be less than 2.0% phase to phase. Excessive phase to phase imbalance can cause severe damage to the drive's power components.

Motor voltage should match line voltage in normal applications. The drive's maximum output voltage will equal the input voltage. Use extreme caution when using a motor with a voltage rating which is different from the input line voltage.

7.1 INPUT VOLTAGE RATINGS

TF200 Series drives are rated for 208/240 Vac, three phase, 50-60 Hz input. The drive will function with input voltages of 208 to 240 Vac (+10%, -15%) at 48 to 62 Hz.

TF200Y Series drives are rated for 208/240 Vac, single or three phase, 50-60 Hz input. The drive will function with input voltage of 208 to 240 Vac (+10%, -15%) at 48 to 62 Hz.

TF400 Series drives are rated for 400/480 Vac three phase, 50-60 Hz input. The drive will function with input voltages of 400 to 480 Vac (+10%, -15%) at 48 to 62 Hz.

TF500 Series drives are rated for 480/590 Vac, three phase, 50-60 Hz input, and will function with input voltages of 480 to 590 Vac (+10%, -15%) at 48 to 62 Hz.



NOTE

Parameter 01 - LINE VOLTAGE SELECTION must be programmed according to the applied input voltage. Refer to Section 15 - DESCRIPTION OF PARAMETERS.

7.2 INPUT FUSING & DISCONNECT REQUIREMENTS

A circuit breaker or a disconnect switch with fuses must be provided in accordance with the National Electric Code (NEC) and all local codes. Refer to the following tables for proper fuse/circuit breaker ratings and wire sizes.

INPUT FUSE & CIRCUIT BREAKER RATINGS							
208/240 Vac, 1 phase		208/240 Vac, 3 phase		400/480 Vac, 3 phase		480/590 Vac, 3 phase	
MODEL	RATING	MODEL	RATING	MODEL	RATING	MODEL	RATING
TF205Y	10 A	TF205Y	10 A	TF405	10 A		
TF210Y	15 A	TF210(Y)	10 A	TF410	10 A	TF510	10 A
TF215Y	20 A	TF215(Y)	12 / 10 A	TF415	10 A		
TF220Y	25 / 20 A	TF220(Y)	15 / 12 A	TF420	10 A	TF520	10 A
TF230Y	30 / 25 A	TF230(Y)	20 / 15 A	TF430	10 A	TF530	10 A
		TF250	30 / 25 A	TF450	15 A	TF550	12 A
		TF275	45 / 40 A	TF475	20 A	TF575	20 A
		TF2100	50 / 50 A	TF4100	30 / 25 A	TF5100	20 A



NOTE

- Applicable national and local electrical codes take precedence over recommendations in these tables.
- Use UL Class CC fast-acting, current limiting type fuses. Select fuses with low I²T values, rated at 200,000 AIC. Recommended fuses are Bussman KTK-R, JJJ, and JJS. Similar fuses with equivalent ratings by other manufacturers may also be acceptable.



WARNING!

This product can cause a DC current in the protective conductor. Where a residual current device (RCD) is used for protection in case of direct or indirect contact, only an RCD of Type B is allowed on the supply side of this product. Otherwise, another protective measure shall be applied, such as separation from the environment by double or reinforced insulation, or isolation from the supply system by a transformer.

Observe the following when using RCDs:

1. Only install the RCD between the supply mains and drive controller.
2. The RCD can be activated by:
 - capacitive leakage currents between the cable screens during operation (especially with long, screened motor cables)
 - connecting several drives to the mains at the same time
 - additional RFI filters

7.3 INPUT WIRE SIZE REQUIREMENTS

INPUT WIRE SIZE REQUIREMENTS											
208/240 Vac, 1 phase			208/240 Vac, 3 phase			400/480 Vac, 3 phase			480/590 Vac, 3 phase		
MODEL	AWG	mm2	MODEL	AWG	mm2	MODEL	AWG	mm2	MODEL	AWG	mm2
TF205Y	14	1.5	TF205Y	14	1.5	TF405	14	1.5	TF510	14	1.5
TF210Y	14	1.5	TF210(Y)	14	1.5	TF410	14	1.5			
TF215Y	12	2.5	TF215(Y)	14	1.5	TF415	14	1.5			
TF220Y	12	2.5	TF220(Y)	14	1.5	TF420	14	1.5	TF520	14	1.5
TF230Y	10	4.0	TF230(Y)	12	2.5	TF430	14	1.5	TF530	14	1.5
			TF250	10	4.0	TF450	14	1.5	TF550	14	1.5
			TF275	8	6.0	TF475	12	2.5	TF575	14	1.5
			TF2100	8	10	TF4100	10	4.0	TF5100	12	2.5

7.4 INSTALLATION ACCORDING TO EMC REQUIREMENTS

This drive can be installed to meet the European standards for Electromagnetic Compatibility (EMC) requirements. These requirements govern the permissible electromagnetic emissions and immunity, both radiated and conducted, of a drive system.

The EMC requirements apply to the final installation in its entirety, not to the individual components used. Because every installation is different, the recommended installation should follow these guidelines as a minimum. Additional equipment (such as ferrite core absorbers on power conductors) or alternative wiring practices may be required to meet conformance in some installations.

Filter: The input to the drive (or group of drives) must include a filter to reduce the electrical noise reflected back to the AC Line. To meet the industrial standards set by the EU, EN 61800-3 for conducted emissions and EN 55011 for radiated emissions to class A compliance, the drive must be installed with an appropriate filter and a maximum motor cable length of 10m.

<p>EMC Compliance with EN 61800-3/A11</p>	
<p>Installation: Shielded cable must be used for all control and power cables and exposed wiring must be kept as short as possible.</p>	
<p>[A] Screen clamps [B] Control cable [C] Low-capacitance motor cable (core/core < 75 pF/m, core/screen < 150 pF/m) [D] Electrically conductive mounting plate [E] Filter</p>	

8 POWER WIRING



DANGER!

Hazard of electrical shock!

Capacitors retain charge after power is removed. Disconnect incoming power and wait until the voltage between terminals B+ and B- is 0 VDC before servicing the drive.

Note drive input and output current ratings and check applicable electrical codes for required wire type and size, grounding requirements, over-current protection, and incoming power disconnect, before wiring the drive. Size conservatively to minimize voltage drop.

Refer to Section 9 - TCF POWER WIRING DIAGRAM for information on torque and wire stripping requirements for power wiring.

Input fusing and a power disconnect switch or contactor **MUST** be wired in series with terminals L1, L2, and L3 for three phase input models. For 208/240 Vac single phase input models, use terminals L1 and L3. This disconnect must be used to power down the drive when servicing, or when the drive is not to be operated for a long period of time, but should not be used to start and stop the motor.

Repetitive cycling of a disconnect or input contactor (more than once every two minutes) may cause damage to the drive.

8.1 WIRING FOR SINGLE PHASE OR THREE PHASE INPUT

If the drive is rated for single and three phase input (TF200Y models), wire to terminals L1 and L3 for single phase input, or wire to terminals L1, L2, and L3 for three phase input.

If the drive is rated for three phase input, wire the input to terminals L1, L2, and L3.

All three power output wires, from terminals T1, T2, and T3 to the motor, must be kept tightly bundled and run in a separate conduit away from all other power and control wiring. It is not recommended to install contactors or disconnect switches between the drive and motor. Operating such devices while the drive is running can potentially cause damage to the drive's power components. If such a device is required, it should only be operated when the drive is in a STOP state. If there is potential for the device to be opened while the drive is running, the drive must be programmed for COAST to stop (refer to Parameter 04 - STOP METHOD), and an auxiliary contact on the device must be interlocked with the drive's run circuit. This will give the drive a stop command at the same time the device opens, and will not allow the drive to start again until the device is closed.

9 TCF POWER WIRING DIAGRAM

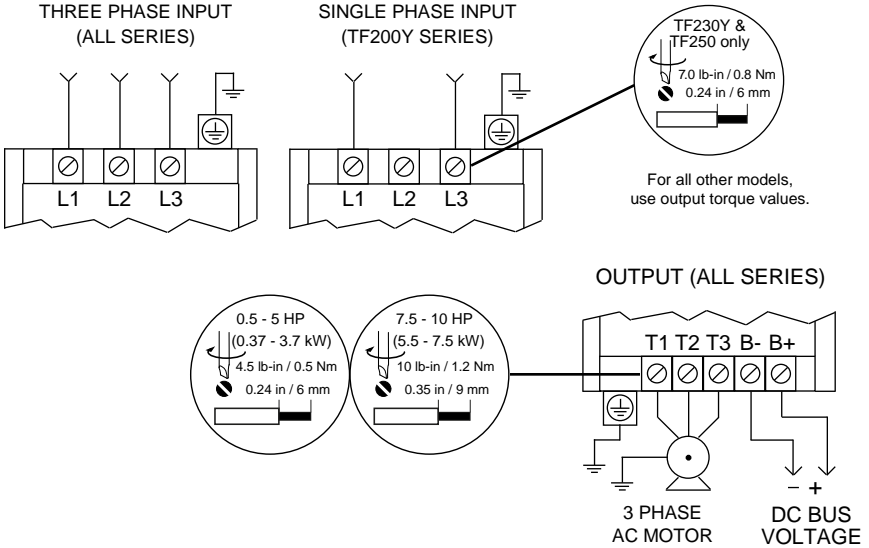

STOP!

- Do NOT connect AC line power to output terminals T1, T2, or T3. Severe damage to the drive will result.
- Leakage current may exceed 3.5 mA AC. Minimum size of the protective earth conductor shall comply with local safety regulations for high leakage current equipment.
- Wire and Ground in accordance with NEC or CEC, and all applicable local codes.
- Motor wires MUST be run in a separate steel conduit away from control wiring and incoming AC power wiring.
- Do not install contactors between the drive and the motor without consulting Lenze-AC Tech for more information. Failure to do so may result in drive damage.
- Use only UL and CSA listed and approved wire.
- Minimum wire voltage rating is 300 V for 120, 208, and 240 Vac systems, and 600 V for 400 and 480 Vac systems.
- Wire gauge must be based on a minimum of 125% of the rated input/output current of the drive, and a minimum 75°C insulation rating. Use copper wire only.

10 CONTROL WIRING

10.1 CONTROL WIRING VS. POWER WIRING

External control wiring **MUST** be run in a separate conduit away from all other input and output power wiring. If control wiring is not kept separate from power wiring, electrical noise may be generated on the control wiring that will cause erratic drive behavior. Use twisted wires or shielded cable grounded at the drive chassis **ONLY**. Recommended control wire is Belden 8760 or 8770, or equivalent.



NOTE

Control terminals provide basic isolation (insulation per EN 61800-5-1). Protection against contact can only be assured by additional measures e.g. supplemental insulation.

Strip off 0.20 to 0.25 inches (5 to 6 mm) of insulation for control wiring, and torque the terminals to 2 lb-in (0.2 Nm). Be careful not to overtorque the terminals, as this will cause damage to the terminal strip. This is not covered under warranty and can only be repaired by replacing the control board.

10.2 TB-2 AND TB-4

The TB-2 terminals are the circuit common for the analog input and analog output functions. The TB-4 terminals are the reference for all of the digital inputs (TB-1, 13A, 13B, 13C, and 13D). The digital inputs are active-high as standard, but can be configured for active-low during initial set-up. Refer to APPENDIX B - INPUT ASSERTION LEVEL. When set for active-high, TB-4 is at +12 VDC.



NOTE

TB-2 may be connected to chassis ground if noise is a concern. TB-2 must be connected to chassis ground when using serial communications.

10.3 SURGE SUPPRESSION ON RELAYS

Current and voltage surges and spikes in the coils of contactors, relays, solenoids, etc, near or connected to the drive, can cause erratic drive operation. Therefore, a snubber circuit should be used on coils associated with the drive. For AC coils, snubbers should consist of a resistor and a capacitor in series across the coil. For DC coils, a free-wheeling or flyback diode should be placed across the coil. Snubbers are typically available from the manufacturer of the device.

10.4 START/STOP CONTROL

There are various control schemes that allow for 2-wire and 3-wire Start/Stop circuits. Refer to the wiring diagrams in Section 11 - TCF CONTROL WIRING DIAGRAMS

10.5 SPEED/TORQUE REFERENCE SIGNALS

SPEED POT	Connect the wiper of the speed pot to terminal TB-5, and the high and low leads to terminals TB-6 and TB-2, respectively. The speed pot can be 2.5k Ω up to 10k Ω .
0-10 VDC	Wire the positive to terminal TB-5 and the negative to terminal TB-2. TB-5 input impedance is 120 k Ω .
-10 to +10 VDC	Connect the signal wire to TB-5 and the common to TB-2. TB-5 input impedance is 120 k Ω . This signal can be used for speed reference only.
4-20 mA	Wire the positive to terminal TB-25 and the negative to terminal TB-2. TB-25 input impedance is 100 Ω .

10.6 SPEED REFERENCE SELECTION

If an analog speed/torque reference input is used to control the drive, terminal TB-13A, 13B, 13C, or 13D (Parameter 10, 11, 12, or 49) may be programmed as the input select for the desired analog input signal. When that TB-13 terminal is then closed to TB-4, the drive will respond to the selected analog reference input.

If an analog speed/torque reference input is not selected on the terminal strip using TB-13A, 13B, 13C, or 13D, control will default to STANDARD mode, which is governed by the setting of Parameter 05 - STANDARD REFERENCE SOURCE. The STANDARD REFERENCE SOURCE can be the ▲ and ▼ buttons on the front of the drive, PRESET SPEED #1 (speed mode only; not torque mode), a 0-10 VDC signal, or a 4-20 mA signal.

0-10 VDC, -10 to +10 VDC, and 4-20 mA INPUT SIGNALS

TB-13A, TB-13B, TB-13C, and TB-13D can all be programmed to select a 0-10 VDC or 4-20 mA analog speed/torque reference input. To select a -10 to +10 VDC bipolar speed input, Parameter 07 - BIPOLAR REFERENCE SELECTION must be set to ENABLE (02), which disables all other speed references except for JOG FORWARD and JOG REVERSE (refer to Parameter 07).

PRESET SPEEDS

TB-13A (or 13D) can be programmed to select PRESET SPEED #1, TB-13B to select PRESET SPEED #2, and TB-13C to select PRESET SPEED #3. There are a total of seven preset speeds, which are activated by different combinations of contact closures between TB-13A (or 13D), 13B, 13C and TB-4. Refer to Parameters 31-37 in Section 15 - DESCRIPTION OF PARAMETERS.

JOG (not available in Vector Torque mode)

TB-13B can be programmed for JOG FORWARD, and TB-13C can be programmed for JOG REVERSE. The JOG FORWARD speed is set by PRESET SPEED #2, and the JOG REVERSE speed is set by PRESET SPEED #4. Close TB-13B or TB-13C to TB-4 to JOG in the desired direction, and open the contact to STOP.

**WARNING!**

When operating in JOG mode, the STOP signal and the AUXILIARY STOP function (Parameters 10-12) WILL NOT stop the drive. To stop the drive, remove the JOG command.

JOG REVERSE will operate the drive in reverse rotation even if ROTATION DIRECTION (Parameter 17) is set to FORWARD ONLY

**NOTE**

If the drive is commanded to JOG while running, the drive will enter JOG mode, but when the JOG command is removed, the drive will STOP.

MOTOR OPERATED POT (MOP) / FLOATING POINT CONTROL

TB-13B and TB-13C are used for this function, which controls the drive speed using contacts wired to the terminal strip. Program TB-13B for DECREASE FREQ (05), and program TB-13C for INCREASE FREQ (05).

Closing TB-13B to TB-4 will cause the speed setpoint to decrease until the contact is opened. Closing TB-13C to TB-4 will cause the speed setpoint to increase until the contact is opened. The INCREASE FREQ function will only operate while the drive is running.

**NOTE**

If TB-13A, TB-13B, TB-13C, and TB-13D are all programmed to select speed references, and two or more of the terminals are closed to TB-4, the higher terminal has priority and will override the others. For example, if TB-13A is programmed to select 0-10 VDC, and TB-13C is programmed to select PRESET SPEED #3, closing both terminals to TB-4 will cause the drive to respond to PRESET SPEED #3 because TB-13C overrides TB-13A.

The exception to this is the MOP function, which requires the use of TB-13B and TB-13C. This leaves TB-13A and TB-13D to be used for other functions. If TB-13A or TB-13D is programmed for a speed reference and that terminal is closed to TB-4, it will override the MOP function.

**NOTE**

This analog output signal cannot be used with "loop-powered" devices that derive power from a 4-20 mA signal.

10.7 ANALOG OUTPUT SIGNALS

Terminal TB-30 can provide a 0-10 VDC or a 2-10 VDC signal proportional to output frequency, load, or torque. The 2-10 VDC signal can be converted to a 4-20 mA signal using a resistor in series with the signal such that the total load resistance is 500 Ohms. Refer to TB-30 OUTPUT (Parameter 08) in Section 15 - DESCRIPTION OF PARAMETERS.

10.8 DRIVE STATUS DIGITAL OUTPUTS

There are two open-collector outputs at terminals TB-14 and TB-15. The open-collector circuits are current-sinking types rated at 30 VDC and 50 mA maximum.

The open-collector outputs can be programmed to indicate any of the following: RUN, FAULT, INVERSE FAULT, FAULT LOCKOUT, AT SPEED, ABOVE PRESET SPEED #3, CURRENT LIMIT, AUTO SPEED MODE, and REVERSE. Refer to Parameters 06 and 13 in Section 15 - DESCRIPTION OF PARAMETERS.

The following diagram illustrates how the 12 VDC power supply at TB-11 can be used with the open-collector output to drive an external relay.

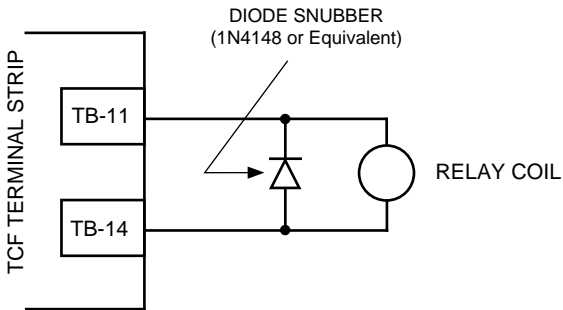

11 TCF CONTROL WIRING DIAGRAMS

11.1 TCF TERMINAL STRIP

The following diagram represents the terminal strip on the main control board and provides a brief description of the function of each terminal.

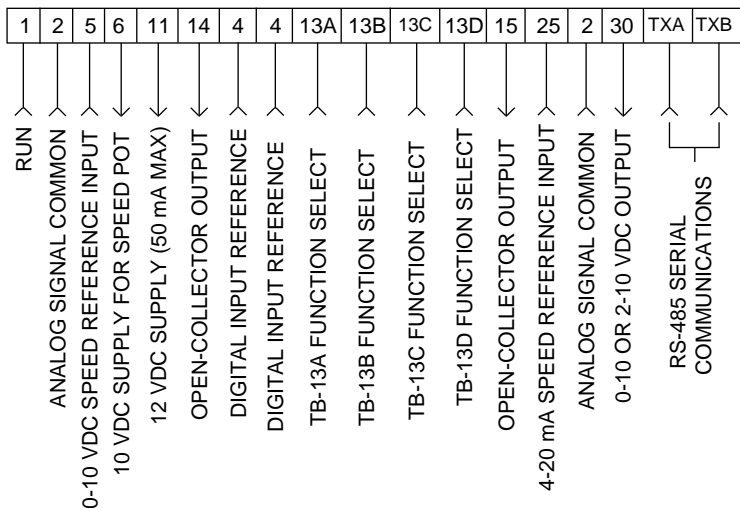

NOTE

- The function of terminals TB-13A, TB-13B, TB-13C, TB-13D, TB-14, TB-15, and TB-30 are dependent on the programming of certain parameters. Refer to Section 15 - DESCRIPTION OF PARAMETERS.
- The following diagrams and their corresponding notes assume that all of the parameters, other than those required for the particular configuration, remain at factory default settings.

Additional information on operating the drive from the terminal strip can be found in Section 10. The diagrams in sections 11.2 - 11.6 provide a quick reference on wiring the drive for the most common configurations using dry contacts to activate the digital inputs. If solid-state circuits are to be used, refer to APPENDIX B - INPUT ASSERTION LEVEL, as the assertion level of the digital inputs may have to be changed to active-low.

11.2 TWO-WIRE START/STOP CONTROL

This wiring diagram shows a typical two-wire start/stop control scheme, using one maintained contact (such as that from a PLC) for RUN and STOP commands, and a selector switch to select rotation direction.

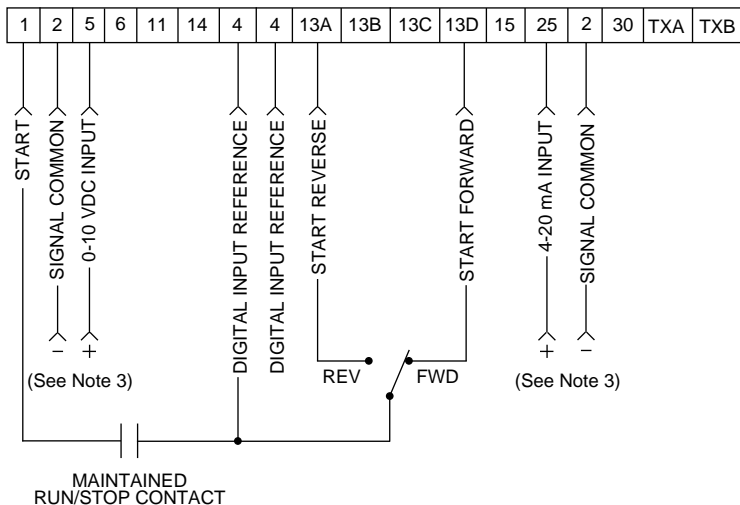

NOTES

- Close TB-1 to TB-4 to RUN, and open TB-1 to TB-4 to STOP.
- For this configuration, ROTATION DIRECTION (Parameter 17) must be set to FORWARD AND REVERSE (02), TB-13A (Parameter 10) must be set to START REVERSE (07), and TB-13D (Parameter 49) must be set to START FORWARD (05).

If reverse rotation is not required, simply close TB-1 to TB-4 to RUN, and open to STOP (no other wiring or programming is required).

- For 0-10 VDC or 4-20 mA speed control, use one of the following methods:
 - Program Parameter 05 - STANDARD REFERENCE SOURCE for 0-10 VDC (03) or 4-20 mA (04). This method is preferable if only one speed source is required, as this method leaves the TB-13 terminals free to be used for other functions.
 - Program one of the TB-13 terminals (13B, 13C are available in this example) for 0-10 VDC (02) or 4-20 mA (03). When that TB-13 terminal is closed to TB-4, the drive will respond to the selected speed reference signal. If that TB-13 terminal is not closed to TB-4, the drive will respond to the speed control source selected in Parameter 05 - STANDARD REFERENCE SOURCE. This method must be used if it is necessary to toggle between two speed sources.

11.3 ALTERNATE TWO-WIRE START/STOP CONTROL

This wiring diagram shows an alternate two-wire start/stop control scheme, using one maintained contact for RUN FORWARD and another maintained contact for RUN REVERSE.

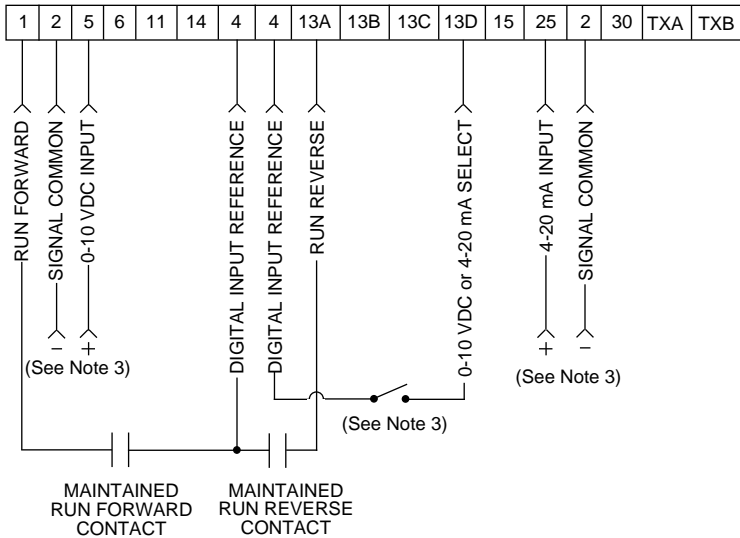

NOTES

- Close TB-1 to TB-4 to RUN FORWARD and open TB-1 to TB-4 to STOP. Close TB-13A to TB-4 to RUN REVERSE and open to STOP.
- For this configuration, ROTATION DIRECTION (Parameter 17) must be set to FORWARD AND REVERSE (02), and TB-13A (Parameter 10) must be set to RUN REVERSE (06).

If reverse rotation is not required, simply close TB-1 to TB-4 to RUN, and open to STOP (no other wiring or programming is required).

- For 0-10 VDC or 4-20 mA speed control, use one of the following methods:
 - Program Parameter 05 - STANDARD REFERENCE SOURCE for 0-10 VDC (03) or 4-20 mA (04). This method is preferable if only one speed source is required, as this method leaves the TB-13 terminals free to be used for other functions.
 - Program one of the TB-13 terminals (13B, 13C or 13D are available in this example) for 0-10 VDC (02) or 4-20 mA (03). When that TB-13 terminal is closed to TB-4, the drive will respond to the selected speed reference signal. If that TB-13 terminal is not closed to TB-4, the drive will respond to the speed control source selected in Parameter 05 - STANDARD REFERENCE SOURCE. This method must be used if it is necessary to toggle between two speed sources.

11.4 THREE-WIRE START/STOP CONTROL

This wiring diagram shows a typical three-wire start/stop control scheme, using momentary contacts (such as push-buttons) for START and STOP commands, and a selector switch to select rotation direction.

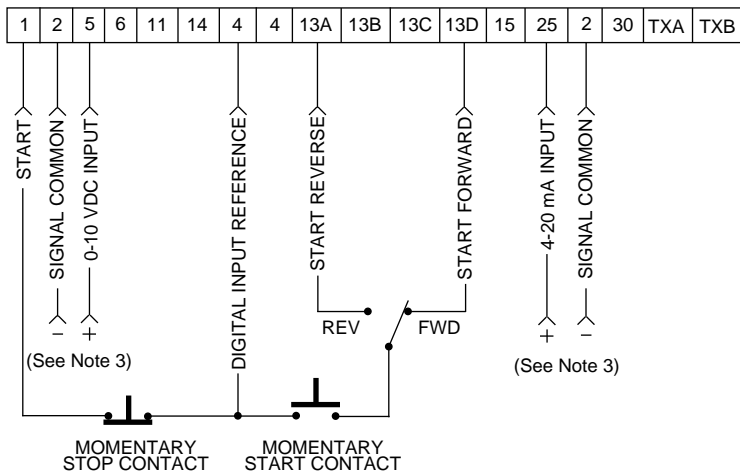

NOTES

- Momentarily close TB-13A or TB-13D to TB-4 to START the drive in the desired direction and momentarily open TB-1 to TB-4 to STOP the drive.
- For this configuration, ROTATION DIRECTION (Parameter 17) must be set to FORWARD AND REVERSE (02), TB-13A (Parameter 10) must be set to START REVERSE (07), and TB-13D (Parameter 49) must be set to START FORWARD (05).

If reverse direction is not required, wire the START push-button directly between TB-4 and TB-13D, and do not program TB-13A for START REVERSE.

- For 0-10 VDC or 4-20 mA speed control, use one of the following methods:
 - Program Parameter 05 - STANDARD REFERENCE SOURCE for 0-10 VDC (03) or 4-20 mA (04). This method is preferable if only one speed source is required, as this method leaves the TB-13 terminals free to be used for other functions.
 - Program one of the TB-13 terminals (13B or 13C are available in this example) for 0-10 VDC (02) or 4-20 mA (03). When that TB-13 terminal is closed to TB-4, the drive will respond to the selected speed reference signal. If that TB-13 terminal is not closed to TB-4, the drive will respond to the speed control source selected in Parameter 05 - STANDARD REFERENCE SOURCE.

11.5 SPEED POT AND PRESET SPEED CONTROL

This wiring diagram illustrates SPEED POT and/or PRESET SPEED control with a two-wire start/stop circuit.

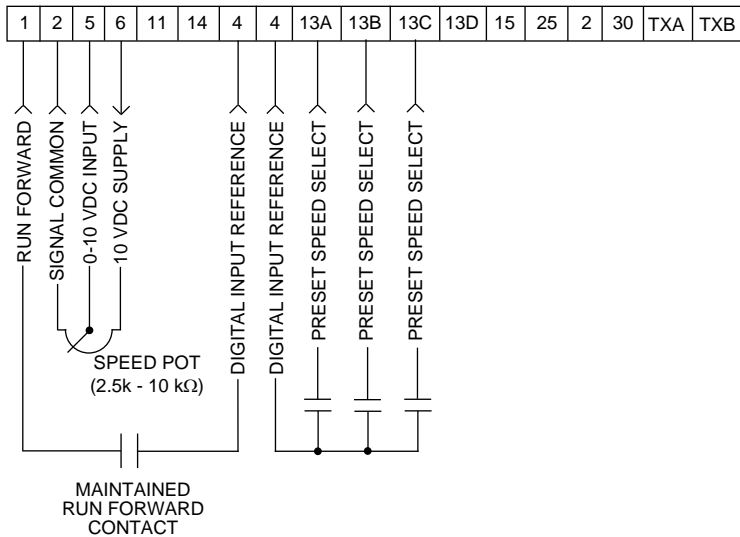

NOTES

- Program the PRESET SPEEDS (Parameters 31-37) to the desired values.
- Program TB-13A (Parameter 10) to PRESET SPEED #1 (04), TB-13B (Parameter 11) to PRESET SPEED #2 (04), and TB-13C (Parameter 12) to PRESET SPEED #3 (04). To select a preset speed, close the appropriate TB-13 terminal(s) to TB-4 (refer to Parameters 31-37 for the Preset Speed Activation table).
- For speed pot control, program Parameter 05 - STANDARD REFERENCE SOURCE for 0-10 VDC (03). If none of the preset speeds are selected (all of the TB-13 terminals are open), the drive will respond to the speed pot.

11.6 BIPOLAR SPEED CONTROL (-10 to +10 VDC)

The three wiring diagrams herein provide examples of using a -10 to +10 VDC bipolar speed reference.

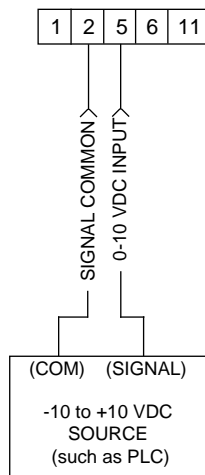
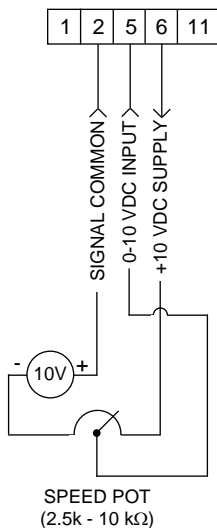
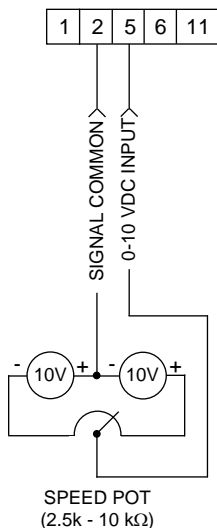

NOTES:

- To use a -10 to +10 VDC speed reference signal, the following parameters must be set:
 - P07 BIPOLAR REFERENCE SELECTION must be set to ENABLE (02).
 - P17 ROTATION must be set to FORWARD AND REVERSE (02).
 - P45 SPEED AT MIN SIGNAL must be set to the maximum desired speed in the reverse direction.
 - P46 SPEED AT MAX SIGNAL must be set to the maximum desired speed in the forward direction.
- In this configuration, all other speed references are disabled except JOG FORWARD and JOG REVERSE.
- In this configuration, the RUN and START functions on TB-13A and TB-13D will only start the drive, they will not select direction. Direction is determined by the polarity of the -10 to +10 VDC signal.

12 INITIAL POWER UP AND MOTOR ROTATION



DANGER!

Hazard of electrical shock!

Capacitors retain charge after power is removed. Disconnect incoming power and wait until the voltage between terminals B+ and B- is 0 VDC before servicing the drive.



STOP!

- Do NOT connect incoming AC power to output terminals T1, T2, and T3! Severe damage to the drive will result.
- Do NOT continuously cycle input power to the drive more than once every two minutes. Damage to the drive will result.
- Severe damage to the drive can result if it is operated after a long period of storage or inactivity without reforming the DC bus capacitors!

If input power has not been applied to the drive for a period of time exceeding three years (due to storage, etc), the electrolytic DC bus capacitors within the drive can change internally, resulting in excessive leakage current. This can result in premature failure of the capacitors if the drive is operated after such a long period of inactivity or storage.

In order to reform the capacitors and prepare the drive for operation after a long period of inactivity, apply input power to the drive for 8 hours prior to actually operating the motor.

Before attempting to operate the drive, motor, and driven equipment, be sure all procedures pertaining to installation and wiring have been properly followed.

Disconnect the driven load from the motor. Verify that the drive input terminals (L1, L2, and L3) are wired to the proper input voltage per the nameplate rating of the drive.

Energize the incoming power line. The LED display will sequence through displays that show the drive's parameter version (500 in the example below), HP rating, and voltage rating. It should then read "- - -", which indicates that the drive is in a STOP condition. The following diagram illustrates the initial LED display sequence.

Apply input power

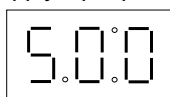

Display flashes parameter version (500-599)



Display flashes HP rating

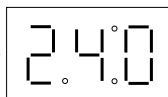

Display flashes voltage rating

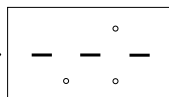

Display shows "- - -" to indicate STOP

Follow the procedure below to check the motor rotation. This procedure assumes that the drive has been powered up for the first time, and that none of the parameters have been changed.

1. Use the ▼ button to decrease the speed setpoint to 00.0 Hz. If the ▼ button is held down, the speed setpoint will decrease by tenths of Hz until the next whole Hz is reached, and then it will decrease by one Hz increments. Otherwise, each push of the ▼ button will decrease the speed setpoint by a tenth of a Hz.
Once 00.0 Hz is reached, the display will toggle between "00.0" and "- -", which indicates that the drive is in a STOP condition with a speed setpoint of 00.0 Hz.
2. Give the drive a START command. This can be done using one of several wiring methods described in Section 11 - TCF CONTROL WIRING DIAGRAMS. Once the START command is issued, the display will read "00.0", indicating that the drive is in a RUN condition with a speed setpoint of 00.0 Hz.
3. Use the ▲ button to increase the speed setpoint until the motor starts to rotate. If the ▲ button is held down, the speed setpoint will increase by tenths of Hz until the next whole Hz is reached, and then it will increase by one Hz increments. Otherwise, each push of the button will increase the speed setpoint by a tenth of a Hz.
4. If the motor is rotating in the wrong direction, give the drive a STOP command and remove power from the drive. Wait three minutes for the bus capacitors to discharge, and swap any two of the motor wires connected to T1, T2, and T3.



NOTE

The drive is phase insensitive with respect to incoming line voltage. This means that the drive will operate with any phase sequence of the incoming three phase voltage. Therefore, to change the motor rotation, the phases must be swapped at the drive output terminals or at the motor.

13 PROGRAMMING THE TCF DRIVE

The drive may be programmed by one of three methods: using the three buttons and 3-digit LED display on the front of the drive, programming the Electronic Programming Module (EPM) using the optional EPM Programmer, and through a serial link using serial communications. This section describes programming the drive using the buttons and display.



NOTE

Refer to Appendix A for information on operating the TCF Series drive in vector mode.



To enter the PROGRAM mode to access the parameters, press the Mode button. This will activate the PASSWORD prompt (if the password has not been disabled). The display will read "00" and the upper decimal point will be blinking as shown below.

Press Mode
Display reads "00"
Upper decimal point blinks

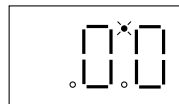

Use the ▲ and ▼ buttons to scroll to the password value (the factory default password is "225") and press the **Mode** button. Once the correct password value is entered, the display will read "P01", which indicates that the PROGRAM mode has been accessed at the beginning of the parameter menu (P01 is the first parameter).

Use ▲ and ▼ to scroll to the password value
Press mode to enter password
Parameter menu is accessed at the first parameter

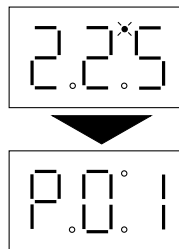

NOTE

If the display flashes "Er", the password was incorrect, and the process to enter the password must be repeated.

Use the ▲ and ▼ buttons to scroll to the desired parameter number. In the example below, Parameter 19 is displayed. Parameter 19 is the ACCELERATION TIME of the drive.

Use ▲ and ▼ to scroll to the desired parameter number (the example is Parameter 19 - ACCELERATION TIME)

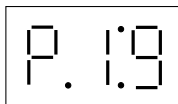

Once the desired parameter number is found, press the **Mode** button to display the present parameter setting. The upper decimal point will begin blinking, indicating that the present parameter setting is being displayed, and that it can be changed by using the ▲ and ▼ buttons.

Press **Mode** to display present parameter setting (example setting is 20.0)

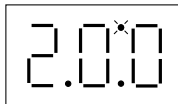

Upper decimal point blinks

Use ▲ and ▼ to change setting (example setting changed to 30.0)



Press **Mode** to store new setting

Pressing the **Mode** will store the new setting and also exit the PROGRAM mode. To change another parameter, press the **Mode** key again to re-enter the PROGRAM mode (the parameter menu will be accessed at the parameter that was last viewed or changed before exiting). If the **Mode** key is pressed within two minutes of exiting the PROGRAM mode, the password is not required to access the parameters. After two minutes, the password must be entered in order to access the parameters again.

13.1 ELECTRONIC PROGRAMMING MODULE (EPM)

Every TCF Series drive has an Electronic Programming Module (EPM) installed on the main control board. The EPM stores the user's parameter settings and special OEM default settings (if programmed). The EPM is removable, allowing it to be installed in another drive for quick set-up. For example, if a drive is being replaced with a new one, the EPM can be taken out of the first drive and installed in the new drive. Downtime is minimized because the new drive does not require programming - it is ready to run when the EPM is installed.

The TCF Series drive contains two or three sets of parameter values, depending on whether the drive has been programmed with optional OEM default settings. The first set of values is the factory default settings, which are permanently stored on the main control board and cannot be changed. The second set of values is the user settings, which are stored in the EPM. When the drive leaves the factory, the user settings are the same as the factory default settings, but the user settings can be changed to configure the drive for a particular application.

The optional third set of values is the OEM default settings, which are also stored in the EPM. OEM default settings are typically used in cases where many drives are used for the same application, which requires that all of the drives have the same parameter settings. The OEM default settings cannot be changed without the optional EPM Programmer. The drive can be programmed to operate according to the user settings or the OEM default settings (refer to Parameter 48 in Section 15).

**NOTE**

The drive will not operate without the EPM installed. The drive will display “F1” if the EPM is missing or damaged. The TCF drive will only work with blue EPMS; the black EPMS will not work.

**STOP!**

Do NOT remove the EPM while power is applied to the drive. Damage to the EPM and/or drive may result.

The EPM Programmer, available as an option from Lenze-AC Tech, has the ability to quickly and easily program many TCF Series drives for the same configuration. Once a “master” EPM is programmed with the desired parameter settings, the EPM Programmer can copy those settings to other EPMS, allowing many drives to be configured very quickly. Consult the EPM Programmer Instruction Manual or contact Lenze-AC Tech for more information.

If the OEM settings in the EPM become corrupted, the drive will operate normally, until an attempt is made to perform a RESET OEM using Parameter 48 - PROGRAM SELECTION. The drive will then flash “GF” to indicate that the OEM settings are no longer valid. This will require that the EPM be re-programmed using the optional EPM Programmer.

If the OEM settings and the user settings are both corrupted, the drive will display “GF” immediately and the drive will require a RESET 60 or RESET 50 using Parameter 48 - PROGRAM SELECTION. Once the RESET is performed, the parameters can then be programmed individually to match the OEM default settings. This will allow the drive to operate as if it were in OEM mode, even though it is actually operating in USER mode. Refer to Parameter 48 in Section 15 - DESCRIPTION OF PARAMETERS.

**NOTE**

The drive will also display “GF” if a RESET OEM or OPERATE WITH OEM SETTINGS is attempted when the EPM does not contain OEM defaults.

13.2 TCF DRIVE PERSONALITY

Each TCF model has a unique "personality" (voltage and HP). This information is stored in the EPM, and is also permanently stored within the drive. If the EPM is replaced, and the personality stored in the EPM does not match the personality stored in the drive, it may trip into a "bF" fault, depending on the information stored on the new EPM.

1. If the new EPM was from a TCF drive that was configured for V/Hz mode (refer to Parameter 80 - DRIVE MODE), the drive will operate normally and will not trip into a "bF" fault. To set up the drive for Vector mode, follow the instructions in Appendix A.
2. If the new EPM was from a TCF drive that was configured for Vector mode or Enhanced V/Hz mode (refer to Parameter 80 - DRIVE MODE), the drive will trip into a "bF" fault. This fault can be reset by one of two methods:
 - a. Perform a RESET 60 or RESET 50 using Parameter 48 - PROGRAM SELECTION. This will reset all of the parameters back to factory defaults. To set up the drive for Vector or Enhanced V/Hz mode, follow the instructions in Appendix A.
 - b. Set parameters 85-91 properly for the connected motor and then set Parameter 94 - DRIVE PERSONALITY to the correct value based on the HP and voltage rating of the drive. Then perform the Auto Calibration function according to the instructions in Appendix A.



NOTE

If an attempt is made to change Parameter 94 - DRIVE PERSONALITY before parameters 85-91 are changed, the drive will display a "GH" fault.

14 PARAMETER MENU

NO.	PARAMETER NAME	RANGE OF ADJUSTMENT	FACTORY DEFAULT (NOTE 1)
01	LINE VOLTAGE	HIGH (01), LOW (02)	HIGH (01)
02	CARRIER FREQUENCY	2kHz (01), 4 kHz (02), 8 kHz (03)	4 kHz (02)
03	START METHOD	NORMAL (01), START ON POWER UP (02), START WITH DC BRAKE (03), AUTO RESTART WITH DC BRAKE (04), FLYING RESTART 1 (05), FLYING RESTART 2 (06)	NORMAL (01)
04	STOP METHOD	COAST (01), COAST WITH DC BRAKE (02), RAMP (03), RAMP WITH DC BRAKE (04)	COAST (01)
05	STANDARD REFERENCE SOURCE	speed mode: KEYPAD (01), PRESET #1 (02), 0-10 VDC (03), 4-20 mA (04) torque mode: KEYPAD (01), KEYPAD (02), 0-10 VDC (03), 4-20 mA (04)	KEYPAD (01)
06 13	TB-14 OUTPUT TB-15 OUTPUT	NONE (01), RUN (02), FAULT (03), INVERSE FAULT (04), FAULT LOCKOUT (05), AT SET SPEED (06), ABOVE PRESET #3 (07), CURRENT LIMIT (08), AUTO SPEED (09), REVERSE (10), DYNAMIC BRAKING (11)	NONE (01) NONE (01)
07	BIPOLAR REFERENCE SELECTION	DISABLE (01), ENABLE (02)	DISABLE (01)
08	TB-30 OUTPUT	NONE (01), 0-10 VDC FREQ (02), 2-10 VDC FREQ (03), 0-10 VDC LOAD (04), 2-10 VDC LOAD (05), 0-10 VDC TORQUE (06), 2-10 VDC TORQUE (07)	NONE (01)
10	TB-13A FUNCTION SELECT	NONE (01), 0-10 VDC (02), 4-20 mA (03), PRESET SPEED #1 (04), START FORWARD (05), RUN REVERSE (06), START REVERSE (07), EXTERNAL FAULT (08), REMOTE KEYPAD (09), DB FAULT (10), AUXILIARY STOP (11), ACCEL/DECCEL #2 (12)	NONE (01)

NOTE 1: Factory defaults are shown for a 60 Hz base frequency. Refer to Parameter 48 for 50 Hz base frequency.

NO.	PARAMETER NAME	RANGE OF ADJUSTMENT	FACTORY DEFAULT (NOTE 1)
11	TB-13B FUNCTION SELECT	NONE (01), 0-10 VDC (02), 4-20 mA (03), PRESET SPEED #2 (04), DECREASE FREQ (05), JOG FORWARD (06), AUXILIARY STOP (07)	NONE (01)
12	TB-13C FUNCTION SELECT	NONE (01), 0-10 VDC (02), 4-20 mA (03), PRESET SPEED #3 (04), INCREASE FREQ (05), EXTERNAL FAULT (06), REMOTE KEYPAD (07), DB FAULT (08), JOG REVERSE (09), ACCEL/DECEL #2 (10)	NONE (01)
13	TB-15 OUTPUT	(SEE PARAMETER 6 - TB-14 OUTPUT)	NONE (01)
14	CONTROL	TERMINAL STRIP ONLY (01), REMOTE KEYPAD ONLY (02), TERMINAL STRIP OR REMOTE KEYPAD (03)	TERMINAL STRIP ONLY (01)
15	SERIAL LINK	DISABLE (01), 9600, 8, N, 2 WITH TIMER (02), 9600, 8, N, 2 WITHOUT TIMER (03), 9600, 8, E, 1 WITH TIMER (04), 9600, 8, E, 1 WITHOUT TIMER (05), 9600, 8, O, 1 WITH TIMER (06), 9600, 8, O, 1 WITHOUT TIMER (07)	9600, 8, N, 2 WITH TIMER (02)
17	ROTATION	FORWARD ONLY (01), FORWARD AND REVERSE (02)	FORWARD ONLY (01)
18	MTR OVERLOAD TYPE	SPEED COMP (01), NO COMP (02)	SPEED COMP (01)
19	ACCELERATION TIME	0.1 - 1300.0 SEC	20.0 SEC
20	DECELERATION TIME	0.1 - 1300.0 SEC	20.0 SEC
21	DC BRAKE TIME	0.0 - 999.0 SEC	0.0 SEC
22	DC BRAKE VOLTAGE	0.0 - 30.0 %	0.00%
23	MINIMUM FREQUENCY	0.0 - MAXIMUM FREQUENCY	0.0 Hz
24	MAXIMUM FREQUENCY	MINIMUM FREQ - 240.0 Hz	60.0 Hz
25	CURRENT LIMIT	50 - 200 % (NOTE 2)	200%
26	MOTOR OVERLOAD	30 - 100 %	100%
27	BASE FREQUENCY	25.0 - 500.0 Hz	60.0 Hz

NOTE 1: Factory defaults are shown for a 60 Hz base frequency. Refer to Parameter 48 for 50 Hz base frequency.

NOTE 2: If LINE VOLTAGE is set to LOW, maximum setting is 167%.

NO.	PARAMETER NAME	RANGE OF ADJUSTMENT	FACTORY DEFAULT (NOTE 1)
28	FIXED BOOST	0.0 - 30.0 %	1.0 %
29	ACCEL BOOST	0.0 - 20.0 %	0.0 %
30	SLIP COMPENSATION	0.0 - 5.0 %	0.0 %
31-37	PRESET SPEEDS	0.0 - MAXIMUM FREQUENCY	0.0 Hz
38	SKIP BANDWIDTH	0.0 - 10.0 Hz	0.0 Hz
39	SPEED SCALING	0.0 - 6500.0	0.0
40	FREQUENCY SCALING	3.0 - 1200.0 Hz	60.0 Hz
41	LOAD SCALING	10 - 200 %	200 %
42	ACCEL/DECEL #2	0.1 - 1300.0 SEC	20.0 SEC
43	SERIAL ADDRESS	1 - 247	1
44	PASSWORD	000 - 999	225
45	SPEED AT MIN SIGNAL	0.0 - 999 Hz	0.0 Hz
46	SPEED AT MAX SIGNAL	0.0 - 999 Hz	60.0 Hz
47	CLEAR HISTORY	MAINTAIN (01), CLEAR (02)	MAINTAIN (01)
48	PROGRAM SELECTION	USER SETTINGS (01), OEM SETTINGS (02), RESET OEM (03), RESET 60 (04), RESET 50 (05), TRANSLATE (06)	USER SETTINGS (01)
49	TB-13D FUNCTION SELECT	NONE (01), 0-10 VDC (02), 4-20 mA (03), PRESET SPEED #1 (04), START FORWARD (05), EXTERNAL FAULT (06), REMOTE KEYPAD (07), DB FAULT (08), AUXILIARY STOP (09), ACCEL/DECEL #2 (10)	NONE (01)
50	SOFTWARE CODE	(VIEW-ONLY)	(N/A)
51	SOFTWARE CODE	(VIEW-ONLY)	(N/A)
52	DC BUS VOLTAGE	(VIEW-ONLY)	(N/A)
53	MOTOR VOLTAGE	(VIEW-ONLY)	(N/A)
54	LOAD	(VIEW-ONLY)	(N/A)
55	0-10 VDC INPUT	(VIEW-ONLY)	(N/A)
56	4-20 mA INPUT	(VIEW-ONLY)	(N/A)

NOTE 1: Factory defaults are shown for a 60 Hz base frequency. Refer to Parameter 48 for 50 Hz base frequency.

NO.	PARAMETER NAME	RANGE OF ADJUSTMENT	FACTORY DEFAULT (NOTE 1)
57	TB STRIP STATUS	(VIEW-ONLY)	(N/A)
58	KEYPAD STATUS	(VIEW-ONLY)	(N/A)
59	TB-30 OUTPUT	(VIEW-ONLY)	(N/A)
73	HEATSINK TEMP	(VIEW-ONLY)	(N/A)
79	INPUT ASSERTION LEVEL	HIGH (01), LOW (02)	HIGH (01)
80	DRIVE MODE	CONSTANT V/Hz (01), VARIABLE V/Hz (02), ENHANCED CONSTANT V/Hz (03), ENHANCED VARIABLE V/Hz (04), VECTOR SPEED (05), VECTOR TORQUE (06)	CONSTANT V/Hz (01)
81	AUTO CALIBRATION	CALIBRATION NOT DONE (00), CALIBRATION CYCLE ENABLED (01), CALIBRATION COMPLETE (02)	CALIBRATION NOT DONE (00)
82	CURRENT LOOP P GAIN	0.00 - 16.0	0.25
83	CURRENT LOOP I GAIN	12 - 9990 mSEC	65 mSEC
84	STATOR RESISTANCE	0.00 - 64.0 OHMS (NOTE 3)	0.00 OHMS
85	MOTOR RATED SPEED	300 - 65000 RPM	1750 RPM
86	MOTOR RATED AMPS	0.0 - 480 AMPS	0.0 AMPS
87	MOTOR RATED VOLTS	0 - 600 Vac	0 Vac
88	MOTOR BASE FREQ	25 - 500 Hz	60 Hz
91	MOTOR COSINE PHI	0.40 - 0.99	0.80
92	MOTOR INDUCTANCE	0.0 - 2000 mH (NOTE 3)	0.0 mH
93	TORQUE LIMIT	0 - 400 %	100%
94	DRIVE PERSONALITY	(NOTE 4)	(NOTE 4)
95	MOTOR CURRENT	(VIEW-ONLY)	(N/A)
96	TORQUE PERCENT	(VIEW-ONLY)	(N/A)

NOTE 1: Factory defaults are shown for a 60 Hz base frequency. Refer to Parameter 48 for 50 Hz base frequency.

NOTE 3: This parameter is automatically set during the AUTO CALIBRATION function.

NOTE 4: Refer to Section 15 - DESCRIPTION OF PARAMETERS.

15 DESCRIPTION OF PARAMETERS

P01 LINE VOLTAGE SELECTION

This calibrates the drive for the actual applied input voltage, and can be set to HIGH (01) or LOW (02). Refer to the table below for the proper setting depending on the input voltage.

MODEL	RATED INPUT VOLTAGE	INPUT PHASE	APPLIED INPUT VOLTAGE	PARAMETER SETTING
TF200Y	208 / 240 Vac	1 or 3	220 - 240 Vac	HIGH (01)
		1 or 3	200 - 208 Vac	LOW (02)
TF200	208 / 240 Vac	3	220 - 240 Vac	HIGH (01)
		3	200 - 208 Vac	LOW (02)
TF400	400 / 480 Vac	3	440 - 480 Vac	HIGH (01)
		3	380 - 415 Vac	LOW (02)
TF500	480 / 590 Vac	3	575 - 600 Vac	HIGH (01)
		3	460 - 480 Vac	LOW (02)



NOTE

If this parameter is changed while the drive is running, the new value will not take effect until the drive is stopped.

P02 CARRIER FREQUENCY

This sets the switching rate of the output IGBT's. Increasing the carrier frequency will result in less audible motor noise. Available settings are: 2 kHz, 4 kHz, and 8 kHz.

The TCF drive is fully rated up to 4 kHz carrier frequency. If the 8 kHz carrier frequency is selected, the drive's ambient temperature rating must be de-rated to 43°C, OR the output current rating must be de-rated to 92%.



NOTE

- If the drive's heatsink temperature gets too hot while running, the carrier frequency will automatically shift to a lower value to increase efficiency and lower heat generation.
- If this parameter is changed while the drive is running, the change will not take effect until the drive is stopped.



WARNING!

Automatic starting of equipment may cause damage to equipment and/or injury to personnel! Automatic start should only be used on equipment that is inaccessible to personnel.

- 01 **NORMAL:** The drive will start when the appropriate contact is closed on the terminal strip, or by pressing the START key on the optional remote keypad. Refer to Parameter 14.
- 02 **START ON POWER UP:** The drive will automatically start upon application of input power.
- 03 **START WITH DC BRAKE:** When a START command is given, the drive will apply DC BRAKE VOLTAGE (Parameter 22) for the duration of DC BRAKE TIME (Parameter 21) prior to starting the motor to ensure that the motor is not turning.
- 04 **AUTO RESTART WITH DC BRAKING:** Upon a START command, after a fault, or upon application of power, the drive will apply DC BRAKE VOLTAGE (Parameter 22) for the duration of DC BRAKE TIME (Parameter 21) prior to starting (or restarting) the motor.
- 05 **FLYING RESTART 1:** Starts the speed search for the motor at MAXIMUM FREQUENCY (Parameter 24). This setting should be used if it is possible for the load to increase speed after the drive trips or loses power.
- 06 **FLYING RESTART 2:** Starts the speed search for the motor at the last frequency it was running at before the drive tripped on a fault or lost power.

The FLYING RESTART 1 and 2 settings allow the drive to start into a spinning load after a fault or upon application of input power. Also, if STOP METHOD (Parameter 04) is set to COAST (01), the drive will perform a flying start whenever it is started (except on application of power).

When programmed for auto-restart, the drive will attempt three restarts after a fault. The interval between restart attempts is 15 seconds for setting 04, and 3 seconds for settings 05 and 06. During the interval between restart attempts, the display will read "SP" to indicate Start Pending. If all three restart attempts fail, the drive will trip into FAULT LOCKOUT (displayed "LC") and require a manual reset. Refer to Section 16 - TROUBLESHOOTING.



NOTE

Settings 02 and 04 - 06 require a two-wire start/stop circuit to operate. The RUN contact must remain closed for the power-up start and auto-restart functions to operate.

P04 STOP METHOD

- 01 COAST TO STOP: When a STOP command is given, the drive shuts off the output to the motor, allowing it to coast freely to a stop.
- 02 COAST WITH DC BRAKE: When a stop command is given, the drive will activate DC braking (after a delay of up to 2 seconds, depending on frequency) to help decelerate the load. Refer to Parameters: 21 - DC BRAKE TIME, and 22 - DC BRAKE VOLTAGE.
- 03 RAMP TO STOP: When a stop command is given, the drive will decelerate the motor to a stop at the rate determined by Parameter 20 - DECELERATION TIME.
- 04 RAMP WITH DC BRAKE: When a stop command is given, the drive will decelerate the motor down to 0.2 Hz (at the rate set by Parameter 20 - DECELERATION TIME) and then activate DC braking according to the settings of Parameters 21 - DC BRAKE TIME and 22 - DC BRAKE VOLTAGE. This is used to bring the load to a final stop, as the motor may still be turning slightly after the drive stops.

P05 STANDARD REFERENCE SOURCE

This selects the default speed or torque reference source for the drive if another reference is not selected using TB-13A, 13B, 13C, or 13D, or Parameter 07 - BIPOLAR REFERENCE SELECTION. The following reference sources can be selected:

- 01 KEYPAD: Use the ▲ and ▼ buttons to scroll to the desired speed/torque.
- 02 PRESET SPEED #1: The drive will operate at frequency set in Parameter 31.
- 03 0-10 VDC: The drive will respond to a 0-10VDC signal wired to TB-2 and TB-5.
- 04 4-20 mA: The drive will respond to a 4-20 mA signal wired to TB-2 and TB-25.



NOTE

When the drive is in VECTOR TORQUE mode (see Parameter 80), setting 02 (PRESET #1) will become the same as setting 01 (KEYPAD). In torque mode, preset speeds cannot be used as torque references.

P06 TB-14 OPEN COLLECTOR OUTPUT

This selects the status indication for the open-collector output at TB-14. The terms “open” and “close” refer to the state of the internal transistor that activates the circuit. When the transistor is “closed”, TB-14 is at the same potential as TB-2, allowing current to flow.

- 01 NONE: Disables the open-collector output.
- 02 RUN: Closes upon a START command. Opens if the drive is in a STOP state, the drive faults, or input power is removed. DC braking is considered a STOP state.
- 03 FAULT: Closes if there is no fault condition. Opens if the drive faults, or input power is removed.
- 04 INVERSE FAULT: Closes if the drive faults. Opens if there is no fault condition.

- 05 FAULT LOCKOUT: Closes when input power is applied. Opens if three restart attempts are unsuccessful, or if input power is removed.
- 06 AT SET SPEED: Closes if the drive is within + 0.5 Hz of the speed setpoint.
- 07 ABOVE PRESET SPEED #3: Closes if the output frequency exceeds the value in PRESET SPEED #3. Opens if the output frequency is equal to or less than the value in PRESET SPEED #3 (Parameter 33).
- 08 CURRENT LIMIT: Closes if the output current exceeds the CURRENT LIMIT setting. Opens if the output current is equal to or less than CURRENT LIMIT (refer to Parameter 25).
- 09 AUTOMATIC SPEED MODE: Closes if an AUTOMATIC (terminal strip) speed reference is selected using TB-13A, 13B, 13C, or 13D. Opens if a STANDARD (Parameter 5) speed reference is active.
- 10 REVERSE: Closes when reverse rotation is active. Opens when forward rotation is active. (Refer to Parameter 17 - ROTATION DIRECTION).
- 11 DYNAMIC BRAKING: Used to "trigger" the optional external Dynamic Braking module. Refer to the instructions included with the Dynamic Braking option.

P07 BIPOLAR REFERENCE SELECTION

This parameter is used to enable the -10 to +10 VDC bipolar speed reference input (cannot be used as a torque reference). Refer to Section 11.6 for -10 to +10 VDC wiring examples.

- 01 DISABLE: The drive will operate normally and respond to the speed reference selected in Parameter 5 - STANDARD REFERENCE SOURCE, or selected using terminals 13A, 13B, 13C, and 13D. Refer to Section 10.6 for more information on speed reference selection.
- 02 ENABLE: The drive will only respond to a -10 to +10 VDC bipolar signal (all other speed references are disabled).

From +0.1 to +10 VDC the drive will operate in the Forward direction, with the maximum speed determined by SPEED AT MAX SIGNAL (Parameter 46) or MAXIMUM FREQUENCY (Parameter 24), whichever is lower.

From -0.1 to -10 VDC, the drive will operate in the Reverse direction, with the maximum speed determined by SPEED AT MIN SIGNAL (Parameter 45) or MAXIMUM FREQUENCY (Parameter 24), whichever is lower.



NOTE

- When setting 02 is selected, Parameter 17 - ROTATION must be set to FORWARD AND REVERSE (02) for the bipolar speed reference to work properly.
 - When setting 02 is selected, the RUN and START functions on terminals TB-13A and TB-13D can only be used to start the drive; they will no longer select direction (direction is only determined by the polarity of the -10 to +10 VDC signal). However, TB-13B and TB-13C can still be used for JOG FORWARD and JOG REVERSE functions.
Refer to Parameters 10, 11, 12, and 49
-

P08 TB-30 ANALOG OUTPUT

Terminal TB-30 can be used as an analog output proportional to output frequency, load or motor torque.

01	NONE	Disables TB-30 Output
02	0-10 VDC FREQUENCY	10 VDC = Setting of P40 - Frequency Scaling
03	2-10 VDC FREQUENCY	
04	0-10 VDC LOAD	10 VDC = Setting of P41 - Load Scaling
05	2-10 VDC LOAD	
06	0-10 VDC TORQUE	10 VDC = Setting of P93 - Torque Limit
07	2-10 VDC TORQUE	



NOTE

The 2-10 VDC signal can be converted to a 4-20 mA signal by connecting a resistor in series with the signal such that the total load resistance is 500 Ohms. However, this output cannot be used with devices that derive power from a 4-20 mA signal.

P10 TB-13A FUNCTION SELECT

This selects the function of terminal TB-13A. Closing TB-13A to TB-4 (or opening in the case of settings 08 and 11) activates the selected function. The following functions can be selected:

- 01 NONE: Disables the TB-13A function.
- 02 0-10 VDC: Sets a 0-10V DC signal (at TB-5) as the AUTO speed reference input.
- 03 4-20 mA: Sets a 4-20 mA signal (at TB-25) as the AUTO speed reference input.
- 04 PRESET SPEED #1: Selects PRESET SPEED #1 as the AUTO speed reference. The drive will operate at frequency programmed in Parameter 31.
- 05 START FORWARD: Momentarily close TB-13A to TB-4 to START the drive in the forward direction. Momentarily open TB-1 to TB-4 to STOP.
- 06 RUN REVERSE: Close TB-13A to TB-4 to RUN in the reverse direction, and open to STOP. Close TB-1 to TB-4 to RUN in the forward direction, and open to STOP.
- 07 START REVERSE: Momentarily close TB-13A to TB-4 to START the drive in the reverse direction. Momentarily open TB-1 to TB-4 to STOP. For forward operation, program TB-13D (Parameter 49) to START FORWARD. Momentarily close TB-13D to TB-4 to START in the forward direction, and momentarily open TB-1 to TB-4 to STOP.
- 08 EXTERNAL FAULT: Sets TB-13A as a normally closed external fault input. If TB-13A is open with respect to TB-4, the drive will fault.
- 09 REMOTE KEYPAD: Selects the optional remote keypad as the control source. Refer to Parameter 14 - CONTROL.
- 10 DB FAULT: Sets TB-13A as a dynamic braking fault input when using the optional dynamic braking module. When this input is activated by the dynamic braking module, the drive will trip into a "dF" fault and the motor will coast to a stop. Refer to the manual included with the Dynamic Braking option.

- 11 AUXILIARY STOP: When TB-13A is opened with respect to TB-4, the drive will decelerate to a STOP (even if STOP METHOD is set to COAST) at the rate programmed into Parameter 42 - ACCEL/DECEL #2.
 - 12 ACCEL/DECEL #2: Selects the acceleration and deceleration time programmed into Parameter 42 - ACCEL/DECEL #2.
-



NOTE

- In order for the RUN REVERSE and START REVERSE functions to operate, Parameter 17 - ROTATION DIRECTION must be set to FORWARD AND REVERSE (02).
 - If a -10 to +10 VDC bipolar speed reference is being used (Parameter 07 - BIPOLAR REFERENCE SELECTION is ENABLED), the RUN and START functions on TB-13A will only start the drive, they will not select direction. Direction is determined by the polarity of the -10 to +10 VDC signal.
-

P11 TB-13B FUNCTION SELECT

This selects the function of terminal TB-13B. Closing TB-13B to TB-4 (or opening in the case of setting 07) activates the selected function. The following functions can be selected:

- 01 NONE: Disables the TB-13B function.
 - 02 0-10 VDC: Selects a 0-10 VDC signal (at TB-5) as the AUTO speed reference input.
 - 03 4-20 mA: Selects a 4-20 mA signal (at TB-25) as the AUTO speed reference input.
 - 04 PRESET SPEED #2: Selects PRESET SPEED #2 as the AUTO speed reference. The drive will operate at the frequency programmed in Parameter 32.
 - 05 DECREASE FREQUENCY: Decreases the speed setpoint when using the MOP function. Refer to Section 10.6.
 - 06 JOG FORWARD: Jog in the forward direction. In this mode, the drive will JOG at the speed programmed into Parameter 32 - PRESET SPEED #2. JOG is not available in Vector Torque mode.
-



WARNING!

When operating in JOG mode, the STOP terminal (TB-1), the AUXILIARY STOP function (setting 07), and the STOP key on the optional remote keypad **WILL NOT** stop the drive. To stop the drive, remove the JOG command



NOTE

If the drive is commanded to JOG FORWARD while running, the drive will enter JOG mode and run at PRESET SPEED #2. When the JOG command is removed, the drive will STOP.

- 07 AUXILIARY STOP: When TB-13B is opened with respect to TB-4, the drive will decelerate to a STOP (even if STOP METHOD is set to COAST) at the rate programmed into Parameter 42 - ACCEL/DECEL #2.

P12 TB-13C FUNCTION SELECT

This selects the function of terminal TB-13C. Closing TB-13C to TB-4 (or opening in the case of setting 06) activates the selected function. The following functions can be selected:

- 01 NONE: Disables the TB-13C function.
- 02 0-10 VDC: Selects a 0-10 VDC signal (at TB-5) as the AUTO speed reference input.
- 03 4-20 mA: Selects a 4-20 mA signal (at TB-25) as the AUTO speed reference input.
- 04 PRESET SPEED #3: Selects PRESET SPEED #3 as the AUTO speed reference. The drive will operate at frequency programmed in Parameter 33.
- 05 INCREASE FREQUENCY: Increases the speed setpoint when using the MOP function. Refer to Section 10.6.
- 06 EXTERNAL FAULT: Sets TB-13C as a normally closed external fault input. If TB-13C is open with respect to TB-4, the drive will fault.
- 07 REMOTE KEYPAD: Selects the optional remote keypad as the control source. Refer to Parameter 14 - CONTROL.
- 08 DB FAULT: Sets TB-13C as a dynamic braking fault input when using the optional dynamic braking module. When this input is activated by the dynamic braking module, the drive will trip into a "dF" fault and the motor will coast to a stop. Refer to the manual included with the Dynamic Braking option.
- 09 JOG REVERSE: Jog in the reverse direction. In this mode, the drive will JOG at the speed programmed into Parameter 34 - PRESET SPEED #4. JOG is not available in Vector Torque mode.
- 10 ACCEL/DECEL #2: Selects the acceleration and deceleration time programmed into Parameter 42 - ACCEL/DECEL #2.



WARNING!

When operating in JOG mode, the STOP terminal (TB-1), the AUXILIARY STOP function (setting 07), and the STOP key on the optional remote keypad **WILL NOT** stop the drive. To stop the drive, remove the JOG command.

JOG REVERSE will operate the drive in reverse rotation even if ROTATION DIRECTION (Parameter 17) is set to FORWARD ONLY.



NOTE

If the drive is commanded to JOG REVERSE while running, the drive will enter JOG mode and run at PRESET SPEED #4. When the JOG command is removed, the drive will STOP.

P13 TB-15 OPEN COLLECTOR OUTPUT

This selects the status indication for the open-collector output at TB-15, and has the same selections as Parameter 6 - TB-14 OPEN COLLECTOR OUTPUT.

P14 CONTROL

This selects the source of START/STOP and direction commands.

- 01 TERMINAL STRIP ONLY: The drive will only respond to START/STOP and direction commands from the terminal strip.
- 02 REMOTE KEYPAD ONLY: The drive will only respond to START/STOP and direction commands from the optional remote keypad.
- 03 TERMINAL STRIP OR REMOTE KEYPAD: Terminal TB-13A, TB-13C, or TB-13D can be used to select terminal strip control or remote keypad control. Refer to Parameters 10, 12, and 49.



NOTE

The STOP button on the optional remote keypad is always active as long as the serial link remains intact.

P15 SERIAL LINK

This parameter configures the drive for Modbus RTU serial communications. The options are listed by baud rate, number of data bits, parity, number of stop bits and whether the watchdog timer is enabled or disabled.



WARNING!

Controlling the drive from the serial link without the watchdog timer could cause damage to equipment and/or injury to personnel!

The watchdog timer will stop the drive after 10 seconds of no serial activity to safeguard against a failed serial link. During set-up or troubleshooting it may be useful to disable the watchdog timer but is it not recommended to run normally without the watchdog timer.

- 01 DISABLED: Disables the serial link
- 02 9600, 8, N, 2 - ENABLED WITH TIMER
- 03 9600, 8, N, 2 - ENABLED WITHOUT TIMER
- 04 9600, 8, E, 1 - ENABLED WITH TIMER
- 05 9600, 8, E, 1 - ENABLED WITHOUT TIMER
- 06 9600, 8, O, 1 - ENABLED WITH TIMER
- 07 9600, 8, O, 1 - ENABLED WITHOUT TIMER

P17 ROTATION DIRECTION

- 01 FORWARD ONLY: The drive will only allow rotation in the forward direction. However, JOG REVERSE (Parameter 12) will still operate even if FORWARD ONLY is selected.
- 02 FORWARD AND REVERSE: The drive will allow rotation in both directions.

P18 MOTOR OVERLOAD TYPE

- 01 SPEED COMPENSATED: Below 40 Hz, the continuous current rating is reduced to protect standard motors that cannot cool themselves effectively at low speeds. From 40 Hz to 0 Hz, the allowable continuous current decreases from 100% to 62%.
- 02 NO COMPENSATION: Full rated current is available throughout the speed range. Only use this setting if the motor is rated for low speed operation under high loads.

P19 ACCELERATION TIME

This parameter sets the acceleration rate for all of the speed reference sources (keypad, speed pot, 4-20 mA, 0-10 VDC, -10 to +10 VDC, jog, MOP, and preset speeds). This setting is the time to accelerate from 0 Hz to the BASE FREQUENCY (Parameter 27).

P20 DECELERATION TIME

This parameter sets the deceleration rate for all of the speed reference sources (keypad, speed pot, 4-20 mA, 0-10 VDC, -10 to +10 VDC, jog, MOP, and preset speeds). This setting is the time to decelerate from BASE FREQUENCY to 0 Hz. If the drive is set for COAST TO STOP (setting 01 or 02 in Parameter 04), this parameter will have no effect when a STOP command is given.

P21 DC BRAKE TIME

This determines the length of time that the DC braking voltage is applied to the motor. If DC BRAKE TIME is set to 999.0 SEC (the maximum value), the DC braking will be continuous (the DC braking will be on whenever the drive is in a STOP state). The DC BRAKE TIME should be set to the lowest value that provides satisfactory operation in order to minimize motor heating.

P22 DC BRAKE VOLTAGE

This sets the magnitude of the DC braking voltage, in percentage of the nominal DC Bus voltage (DC Bus = input AC voltage X 1.414). The point at which the DC braking is activated depends on the selected STOP METHOD (Parameter 04):

If COAST WITH DC BRAKE is selected, the DC braking is activated after a time delay of up to 2 seconds, depending on the output frequency at the time of the STOP command. In this case, the DC braking is the only force acting to decelerate the load.

If RAMP WITH DC BRAKE is selected, braking is activated when the output frequency reaches 0.2 Hz. In this case, the drive decelerates the load to a near stop and the DC braking is used to bring the load to a final stop.

P23 MINIMUM FREQUENCY

This sets the minimum output frequency of the drive for all speed reference sources except the PRESET SPEEDS (Parameters 31-37).



NOTE

If either the Minimum Frequency or Maximum Frequency parameter is changed while the drive is running, the new value will not take effect until the drive is stopped.

P24 MAXIMUM FREQUENCY

This sets the maximum output frequency of the drive for all speed reference sources and is used with MINIMUM FREQUENCY (Parameter 23) to define the operating range of the drive.

P25 CURRENT LIMIT

This sets the maximum allowable output current of the drive. The maximum setting is either 200% or 167%, depending on whether LINE VOLTAGE SELECTION (Parameter 01) is set to HIGH or LOW.

The drive will enter current limit when the load demands more current than the CURRENT LIMIT setting. When this happens, the drive will reduce the output frequency in an attempt to reduce the output current. When the overload condition passes, the drive will accelerate the motor back up to the speed setpoint.

P26 MOTOR OVERLOAD

The TCF Series is UL approved for solid state motor overload protection and therefore does not require a separate thermal overload relay for single motor applications.

The drive contains an adjustable thermal overload circuit that protects the motor from excessive over current. This circuit allows the drive to deliver up to 150% current for one minute. If the overload circuit "times out", the drive will trip into an OVERLOAD fault (displayed as "PF").

MOTOR OVERLOAD should be set to the ratio (in percent) of the motor current rating to the drive current rating in order to properly protect the motor. Refer to the example herein.

Example: A 3 HP, 480 Vac drive with a 4.8 Amp rating is operating a 2 HP motor with a current rating of 3.4 Amps. Dividing the motor current rating by the drive current rating yields 71% ($3.4 / 4.8 = 0.71 = 71\%$), so this parameter should be set to 71%.

P27 BASE FREQUENCY

BASE FREQUENCY is active only in V/Hz mode (Parameter 80) and determines the V/Hz ratio by setting the output frequency at which the drive will output full voltage to the motor. In most cases the BASE FREQUENCY should be set to match the motor's rated frequency.

Example: A 460 Vac, 60 Hz motor requires a V/Hz ratio of 7.67 ($460 \text{ V} / 60 \text{ Hz} = 7.67 \text{ V/Hz}$) to produce full torque. Setting the BASE FREQUENCY to 60 Hz causes the drive to output full voltage (460 Vac) at 60 Hz, which yields the required 7.67 V/Hz. Output voltage is proportional to output frequency, so the 7.67 V/Hz ratio is maintained from 0 - 60 Hz, allowing the motor to produce full torque from 2 Hz (below 2 Hz there is less torque due to slip) up to 60 Hz.



NOTE

If this parameter is changed while the drive is running, the new value will not take effect until the drive is stopped.

P28 FIXED BOOST

FIXED BOOST is active only in V/Hz mode (refer to Parameter 80), and increases starting torque by increasing the output voltage when operating below half of the base frequency, which increases the V/Hz ratio. The factory default setting depends on HP rating, as shown in the following table.

HP	DEFAULT	HP	DEFAULT
0.5 - 1	2.0%	5	1.2%
1.5 - 2	1.8%	7.5	1.0%
3	1.5%	10	1.0%

P29 ACCELERATION BOOST

ACCELERATION BOOST is active only in V/Hz mode (refer to Parameter 80), and helps accelerate high-inertia loads. During acceleration the output voltage is increased to increase motor torque. Once the motor reaches the new speed setpoint the boost is turned off.

P30 SLIP COMPENSATION

SLIP COMPENSATION is active only in V/Hz mode (refer to Parameter 80) and is used to counteract changes in motor speed (slip) caused by changes in load. In a standard AC induction motor, the shaft speed decreases as load increases and increases as load decreases. By increasing or decreasing the output frequency in response to an increasing or decreasing load, the slip is counteracted and speed is maintained. Most standard NEMA B motors have a 3% slip rating.

P31-P37 PRESET SPEED #1 - #7

Preset speeds are activated by contact closures between TB-4 and TB-13A (or 13D), 13B and 13C. The TB-13 terminals must be programmed as preset speed selects using Parameters 10, 11, 12 and 49. Preset Speeds #2 and #4 are also used when the drive is in JOG mode. Refer to Parameters 11 and 12. Preset speeds are not available in Vector Torque mode.



NOTE

Preset speeds can operate below the frequency defined by MINIMUM FREQUENCY (Parameter 23). The range of adjustment for the preset speeds is from 0 Hz to MAXIMUM FREQUENCY (Parameter 24).

Refer to the table herein for activation of the preset speeds using the TB-13 terminals.

SPEED #	TB - 13A or 13D	TB - 13B	TB - 13C
1	CLOSED	OPEN	OPEN
2	OPEN	CLOSED	OPEN
3	OPEN	OPEN	CLOSED
4	CLOSED	CLOSED	OPEN
5	CLOSED	OPEN	CLOSED
6	OPEN	CLOSED	CLOSED
7	CLOSED	CLOSED	CLOSED

Preset Speed #6 and #7 can also be used as skip frequencies to restrict the drive from operating at frequencies that cause vibration in the system. Refer to Parameter 38.



NOTE

- When a TB-13 terminal is programmed for a function other than a preset speed select, it is considered OPEN for the table above.
 - PRESET SPEEDS #6 and #7 can still be used as preset speeds even if they are also being used as skip frequencies.
-

P38 SKIP BANDWIDTH

The TCF drive has two skip frequencies that can be used to lock out critical frequencies that cause mechanical resonance in the system. Once SKIP BANDWIDTH is set to a value other than 0.0 Hz, the skip frequencies are enabled. When the skip frequency function is enabled, PRESET SPEED #6 and #7 are used as the skip frequencies. SKIP BANDWIDTH sets the range above the skip frequencies that the drive will not operate within.

Example: The critical frequency is 23 Hz, and it is desired to skip a frequency range of 3 Hz above and below the critical frequency (therefore the skip range is 20 to 26 Hz). PRESET SPEED #6 or #7 would be set to 20 Hz, and the SKIP BANDWIDTH would be set to 6.0 Hz.

If the drive is running at a speed below the skip range, and it is given a speed command that is within this range, the drive will accelerate to the start of the skip range (20 Hz in the example) and run at that speed until the speed command is greater than or equal to the "top" of the skip range. The drive will then accelerate through the skip range to the new speed. Likewise, if the drive is running at a speed above the skip range, and it is given a speed command that is within the skip range, the drive will decelerate to the "top" of the skip range (26 Hz in the example) and run at that speed until the speed command is less than or equal to the "bottom" of the skip range. The drive will then decelerate through the skip range to the new speed.

P39 SPEED SCALING

This scales the display to indicate speed or user units other than frequency. This parameter should be set to the desired display value when the drive output is 60 Hz. The highest setting is 6500, and the highest value that can be displayed is 6553.6.

Example: A machine produces 175 parts per hour when the motor is running at 60 Hz. Setting the SPEED SCALING to 175 will calibrate the drive's display to read 175 when the motor is running at 60 Hz. This is a linear function, so at 30 Hz the display would read 87.5, and at 120 Hz, the display would read 350.v



NOTE

If SPEED SCALING is set such that the maximum displayed value (6553.6) is exceeded, the display will flash "9999" to indicate that the value is out of range. For example, if SPEED SCALING is set to 6000, the drive will display 6000 when it is running at 60 Hz. If the speed is increased past 65.5 Hz (at 65.5 Hz, the scaled value would be 6550), the display will flash "9999" because a scaled value above 6553.6 cannot be displayed.

P40 FREQUENCY SCALING

This scales the analog output signal at TB-30 when it is configured for a frequency output. This setting is the output frequency that is indicated when the output signal measures 10 VDC.

Example: A 0-5 VDC signal is required to indicate 0-60 Hz. Setting this parameter to 120 Hz would yield 10 VDC at 120 Hz, and 5 VDC at 60 Hz. If the drive only operates up to 60 Hz, the output signal at TB-30 is limited to the desired 0-5 VDC.

P41 LOAD SCALING

This scales the analog output signal at TB-30 when it is configured for a load output. This setting is the load (in %) that is indicated when the output signal measures 10 VDC.

Example: A 0-10 VDC signal is required to indicate 0-150% load. Setting this parameter to 150% will yield 10 VDC at 150% load.

P42 ACCEL/DECEL #2

This parameter sets the second acceleration and deceleration rate of the drive. To activate this acceleration and deceleration rate, use terminals TB-13A, TB-13B, TB-13C, or TB-13D. TB-13A, TB-13B and TB-13D can be set to AUXILIARY STOP which will cause the drive to decelerate to a stop according to the time programmed in this parameter. TB-13A, TB-13C and TB-13D can be set to ACCEL/DECEL #2 which causes the drive to accelerate and decelerate according to the time programmed in this parameter.

P43 SERIAL ADDRESS

If a serial link is being used to communicate with multiple drives, each drive must be given a different address (from 1 to 247) so that an individual drive in the network can be accessed.

P44 PASSWORD

This allows the PASSWORD to be changed to any number between 000 and 999. Setting PASSWORD to 000 disables the password function.



NOTE

The factory default password is 225.

P45 SPEED AT MIN SIGNAL

This sets the speed at which the drive will run when it receives the minimum speed reference signal (0 VDC or 4 mA). This is used in conjunction with SPEED AT MAX SIGNAL (Parameter 46) to define the speed range of the drive when following an analog speed reference signal.



NOTE

When the drive is configured for -10 to +10 VDC speed control, SPEED AT MIN SIGNAL will set the maximum speed that the drive will run at in reverse direction when it receives -10 VDC. Refer to Parameter 07 - BIPOLAR REFERENCE SELECTION.

P46 SPEED AT MAX SIGNAL

This sets the speed at which the drive will run when it receives the maximum speed reference signal (10 VDC or 20 mA). This is used in conjunction with SPEED AT MIN SIGNAL (Parameter 45) to define the speed range of the drive when following an analog speed reference signal.



NOTE

If SPEED AT MIN SIGNAL is set higher than SPEED AT MAX SIGNAL, the drive will react inversely to the speed reference signal. Therefore, as the speed reference signal increases, the drive speed will decrease, and vice-versa. This function is disabled when using a -10 to +10 VDC speed reference signal. Refer to Parameter 07 - BIPOLAR REFERENCE SELECTION.

P47 CLEAR FAULT HISTORY

- 01 MAINTAIN: Maintains the FAULT HISTORY (Parameter 50) entries for troubleshooting.
- 02 CLEAR: Erases the FAULT HISTORY (Parameter 50) entries.

P48 PROGRAM SELECTION

This is used to select whether the drive will operate according to the user settings or the optional OEM default settings and to reset the parameters to default settings. Refer to Section 13.1.

- 01 OPERATE WITH USER SETTINGS: The drive will operate according to the user settings. Operation in USER mode allows the parameter values to be changed to suit any application.
- 02 OPERATE WITH OEM DEFAULTS: The drive will operate according to the optional OEM default settings, which configure the drive for a specific application. When operating in OEM mode, the parameter values can be viewed, but not changed. If an attempt is made to change a parameter setting, the display will flash "GE". If the drive is not programmed with OEM default settings, the display will flash "GF" if this option is selected.
- 03 RESET OEM: Resets the user parameters to the OEM default settings. If the drive is not programmed with OEM default settings, the display will flash "GF" if this option is selected.
- 04 RESET 60: Resets the user parameters to the factory defaults for a 60 Hz base frequency.
- 05 RESET 50: Resets the user parameters to the factory defaults for a 50 Hz base frequency. Parameters 24, 27, 40, 46 and 88 will reset to 50.0 Hz, and Parameter 85 will reset to 1450 RPM.
- 06 TRANSLATE: If an EPM from a drive with a previous parameter version is installed in a new drive, the new drive will function like the previous version drive, but none of the parameter settings can be changed ("cE" will be displayed if this is attempted). The TRANSLATE function converts the EPM to the new parameter version so that the parameters can be changed, but it also retains the old parameter settings so the new drive will operate like the old drive without having to re-program all of the parameters.



NOTE

- If the user parameters are reset to the OEM defaults (using the RESET OEM option), and then OPERATE WITH USER SETTINGS is selected, the USER settings will be the same as the OEM default settings. This allows the drive to operate as if it was in OEM mode, but the parameter values can be changed. This is useful if some of the OEM default settings need to be fine-tuned for proper operation. The new parameter values are not actually stored as new OEM default settings however; they are simply stored as new USER settings. Therefore, if the parameters are reset to the OEM defaults again the parameters that were changed will be reset to their "old" value. The optional EPM Programmer is required to change OEM default settings. Refer to Section 13.2.
 - Only the TRANSLATE (06) function can be performed while the drive is running. The display will flash "Er" if an attempt is made to select any other function while the drive is running.
-

P49 TB-13D FUNCTION SELECT

This selects the function of terminal TB-13D. Closing TB-13D to TB-4 (or opening in the case of settings 06 and 09) activates the selected function. These functions are selectable:

- 01 NONE: Disables the TB-13D function.
- 02 0-10 VDC: Selects a 0-10 VDC signal (at TB-5) as the AUTO speed reference input.
- 03 4-20 mA: Selects a 4-20 mA signal (at TB-25) as the AUTO speed reference input.
- 04 PRESET SPEED #1: Selects PRESET SPEED #1 as the AUTO speed reference. The drive will operate at the frequency programmed into Parameter 31.
- 05 START FORWARD: Momentarily close TB-13D to TB-4 to START in the forward direction, and momentarily open TB-1 to TB-4 to STOP. For reverse operation, program TB-13A (Parameter 10) to START REVERSE (07). Momentarily close TB-13A to TB-4 to START in the reverse direction, and momentarily open TB-1 to TB-4 to STOP
- 06 EXTERNAL FAULT: Sets TB-13D as a normally closed external fault input. If TB-13D is open with respect to TB-4, the drive will fault.
- 07 REMOTE KEYPAD: Selects the optional remote keypad as the control source. Refer to Parameter 14 - CONTROL.
- 08 DB FAULT: Sets TB-13D as a dynamic braking fault input when using the optional dynamic braking module. When this input is activated by the dynamic braking module, the drive will trip into a "dF" fault and the motor will coast to a stop. Refer to the manual included with the Dynamic Braking option.
- 09 AUXILIARY STOP: When TB-13D is opened with respect to TB-4, the drive will decelerate to a STOP (even if STOP METHOD is set to COAST) at the rate programmed into Parameter 42 - ACCEL/DECEL #2.
- 10 ACCEL/DECEL #2: Selects the acceleration and deceleration time programmed into Parameter 42 - ACCEL/DECEL #2.



NOTE

If a -10 to +10 VDC bipolar speed reference is being used (Parameter 07 - BIPOLAR REFERENCE SELECTION is ENABLED), the START FORWARD function on TB-13D will only start the drive, it will not select direction. Direction is determined by the polarity of the -10 to +10 VDC signal.

P50 FAULT HISTORY

The FAULT HISTORY stores the last eight faults that tripped the drive. Refer to Section 16 - TROUBLESHOOTING for a list of the faults and possible causes.

Use the ▲ and ▼ buttons to scroll through the fault entries. The far left digit of the display will be the fault number and the remaining two digits will be the fault code. The faults are stored from newest to oldest, with the first fault shown being the most recent.

The display will read “_ _ _” if the FAULT HISTORY does not contain any fault messages.

P51 SOFTWARE VERSION

This displays the software version number for the control board software. This information is useful when contacting the factory for programming or troubleshooting assistance.

The software version is displayed in two parts which alternate. The first part is the software version, and the second part is the revision number. For example, if the display shows "106" and "-02" this indicates that the drive contains the second revision of version 106 software.

P52 DC BUS VOLTAGE

This displays the DC bus voltage in percent of nominal. Nominal DC bus voltage is determined by multiplying the drive's nameplate input voltage rating by 1.4.

P53 MOTOR VOLTAGE

This displays the output voltage in percent of the drive's nameplate output voltage rating.

P54 MOTOR LOAD

This displays the motor load in percent of the drive's output current rating.

P55 0-10 VDC ANALOG INPUT

This displays the level of the 0-10 VDC analog input signal at TB-5. A reading of 100% indicates a 10 VDC input at TB-5.



NOTE

If the -10 to +10 VDC bipolar input is used, this parameter will display 0% at -10 VDC, 50% at 0 VDC, and 100% at +10 VDC.

P56 4-20 mA ANALOG INPUT

This displays the level of the 4-20 mA analog input signal at TB-25. A reading of 20% indicates a 4 mA input at TB-25, and a reading of 100% indicates a 20 mA input at TB-25.

P57 TERMINAL STRIP STATUS

This indicates the status of several terminals using the vertical segments of the LED display. An illuminated segment indicates that the particular terminal is closed with respect to TB-2. The CHARGE RELAY is not a terminal, and should always be illuminated. Refer to the diagram herein.

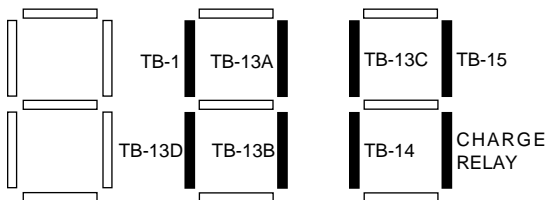

P58 KEYPAD AND PROTECTION STATUS

This indicates the status of the buttons on the keypad and the status of the protective circuitry in the drive, using the horizontal segments of the LED. An illuminated segment indicates that the corresponding button is pressed, or the protective circuit is active. Refer to the following diagram.

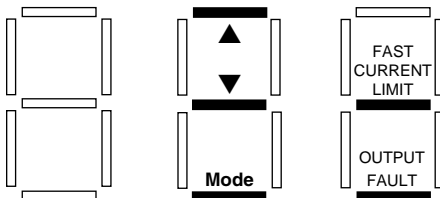

P59 TB-30 ANALOG OUTPUT

This displays the level of the analog output signal at TB-30. A reading of 100% indicates that the output is 10 VDC.

P73 HEATSINK TEMPERATURE

This displays the heatsink junction temperature in degrees C.

P79 INPUT ASSERTION LEVEL

The digital inputs (TB-1, 13A, 13B, 13C and 13D) are configured for active-high as standard, but can be changed to active-low during initial set-up. If dry contacts (such as relays, switches, push-buttons, etc) are to be used to activate the digital inputs, it should not be necessary to change the assertion level.

If solid-state circuits are to be used to activate the digital inputs, it may be necessary to change the assertion level depending on the type of circuit (PNP/sourcing or NPN/sinking). Refer to APPENDIX B - INPUT ASSERTION LEVEL for more information, and for the procedure to change the digital inputs to active-low (changing this parameter requires a special password).

When set for HIGH (01), TB-4 is at +12 VDC and the digital inputs are activated when they are at +10 VDC or higher (24 VDC max) relative to TB-4.

When set for LOW (02), TB-4 is at 0 VDC and the digital inputs are activated when they are at +2 VDC or lower relative to TB-4.

P80 DRIVE MODE

This selects whether the drive will operate in V/Hz mode or vector mode:

- 01 CONSTANT V/Hz: Selects constant torque V/Hz mode. This setting is best for general purpose industrial applications that do not require vector performance.
- 02 VARIABLE V/Hz: Selects variable torque V/Hz mode. This setting will achieve maximum energy savings in variable torque applications such as centrifugal fans and pumps.
- 03 ENHANCED CONSTANT V/Hz: Achieves maximum performance in V/Hz mode. This setting is for applications that require high performance but cannot use vector mode, such as multiple motor applications.

- 04 ENHANCED VARIABLE V/Hz: Achieves maximum performance for variable torque applications. This setting may be required for high inertia fan applications that require fast acceleration and deceleration.
- 05 VECTOR SPEED: Selects vector speed mode. This setting achieves maximum performance for speed control.
- 06 VECTOR TORQUE: Selects vector torque mode. This setting is for applications where torque needs to be controlled rather than speed.



NOTE

- If setting 01 or 02 is selected all parameters above 80 will be hidden. If setting 03 or 04 is selected parameters 84, 85 and all parameters above 87 will be hidden.
 - If setting 03-06 is selected the AUTO CALIBRATION (Parameter 81) function must be performed and the appropriate motor characteristic parameters must be programmed properly.
 - If setting 06 is selected the available settings in Parameter 05 - STANDARD REFERENCE SOURCE change. Setting 02 (normally PRESET #1), becomes the same as setting 01 (KEYPAD).
-

P81 AUTO CALIBRATION

This is used in the ENHANCED V/Hz and VECTOR modes to measure certain motor characteristics to achieve maximum motor performance. Select setting 01 to perform the calibration cycle on the next start command. Setting 02 cannot be selected unless the calibration cycle has already been completed.

- 00 CALIBRATION NOT DONE: Drive cannot be operated in VECTOR mode if this parameter value is 00.
- 01 CALIBRATION CYCLE ENABLED: Calibration will occur on the next start command and will take about 40 seconds to complete. Once the calibration cycle is successfully completed, this parameter will display "02" to indicate that the drive can run in vector mode.
- 02 CALIBRATION COMPLETE: The drive can be operated in vector mode.



NOTE

Prior to performing the AUTO CALIBRATION, Parameters 85-88 and 91 must be set properly based on the motor data. Refer to Appendix B - VECTOR MODE for more information.

P82 CURRENT LOOP P GAIN

Normally, this parameter should not require adjustment. In special cases, however, it may need to be adjusted to optimize performance. Do not change this parameter without consulting Lenze-AC Tech.

P83 CURRENT LOOP I GAIN

Normally, this parameter should not require adjustment. In special cases, however, it may need to be adjusted to optimize performance. Do not change this parameter without consulting Lenze-AC Tech.

P84 MOTOR STATOR RESISTANCE

This will be automatically adjusted when the AUTO CALIBRATION (Parameter 81) function is performed. Once the AUTO CALIBRATION function is performed, this setting should not be changed.

P85 MOTOR RATED SPEED

Enter the motor's nameplate RPM rating.

P86 MOTOR RATED CURRENT

Enter the motor's nameplate full-load current rating.

P87 MOTOR RATED VOLTAGE

Enter the motor's nameplate voltage rating. If the motor is dual-rated, enter the voltage that matches the supply voltage being used.

P88 MOTOR BASE FREQUENCY

Enter the motor's nameplate frequency.

P91 MOTOR COSINE PHI (POWER FACTOR)

Use the following formulas to determine the appropriate value to enter, depending on the available motor data:

1. If the motor's power factor is known, simply enter that value.
2. If the motor's magnetizing current is known:

$$\text{COS } \Phi = \text{COS} \left[\text{SIN}^{-1} \left(\frac{\text{Magnetizing Current}}{\text{Motor Current}} \right) \right]$$

Example 1: A motor has a full-load current rating of 8 amps and a magnetizing current of 4 amps. Using the above formula yields a result of 0.87:

$$\begin{aligned} 4/8 &= 0.5 \\ \text{sin}^{-1} (0.5) &= 30 \\ \text{cos} (30) &= 0.866 = 0.87 \end{aligned}$$

3. If the motor's power factor or magnetizing current is not available, but the efficiency is known:

$$\text{COS } \Phi = \frac{\text{Motor HP X 746}}{\text{Motor Efficiency X Motor Voltage X Motor Current X 1.732}}$$

Example 2: A 10 Hp 460 Vac motor has an efficiency of 85% and a full-load current rating of 13 amps. Using the formula above yields a result of 0.85:

$$\begin{aligned} 10 \times 746 &= 7460 \\ 0.85 \times 460 \times 13 \times 1.732 &= 8804 \\ 7460/8804 &= 0.847 = 0.85 \end{aligned}$$

P92 MOTOR INDUCTANCE

This will be automatically adjusted when the AUTO CALIBRATION (Parameter 81) function is performed. Once the AUTO CALIBRATION function is performed, this setting should not be changed.

P93 TORQUE LIMIT

When the drive is in VECTOR TORQUE mode (refer to Parameter 80) this parameter sets the maximum output torque. In this mode, the torque reference source can be the keypad (**▲** and **▼** buttons), a 0-10 VDC signal, or a 4-20 mA signal (preset speeds cannot be used as torque references). The drive will run at the fastest speed possible to deliver the desired torque.

P94 DRIVE PERSONALITY

This parameter will display the drive's "personality" by indicating the voltage and HP rating. The displayed value is 3 digits.

The first digit indicates the voltage (2 = 208/240 Vac; 4 = 400/480 Vac, 5 = 480/590 Vac). If the drive is rated for single-phase and three-phase input (model numbers that end in "Y"), the left bottom decimal point will illuminate to distinguish it from a three-phase only model. Refer to the examples herein.

The second and third digits indicate the HP rating (01 = 1 HP, 02 = 2 HP, etc). If the drive's HP rating is 0.5, 1.5, or 7.5, the bottom right decimal point will be illuminated. Refer to the examples herein.

Example 1: The displayed value is "405". The "4" indicates that the drive is a 400/480 Vac model, and the "05" indicates that it is rated 5 HP.

Example 2: The displayed value is "2.1.5". The "2" with the bottom left decimal point illuminated indicates that the drive is a 208/240 Vac model that can accept single-phase or three-phase input. The "1.5" indicates that the drive is rated 1.5 HP.

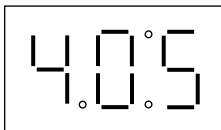

Example 1

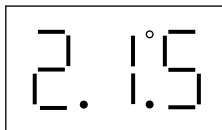

Example 2



NOTE

If the personality stored on the EPM does not match the drive model, the drive may trip into a "bF" fault. Refer to Section 13.2.

P95 MOTOR CURRENT

This displays the current (in amps) that the motor is drawing.

P96 MOTOR TORQUE

This displays the torque (in %) that the motor is generating.

16 TROUBLESHOOTING

To aid in troubleshooting, Parameters 50 through 59, 73, 95 and 96 can be accessed without entering the PASSWORD (Parameters 95 and 96 are only visible if the drive is operating in VECTOR mode). Simply press the Mode button twice to “skip” over the PASSWORD prompt, and “P50” will be displayed to indicate that the parameter menu has been entered and Parameter 50 (FAULT HISTORY) can be viewed. The s and t buttons can then be used to scroll from Parameter 50 through 59, 73, 95 and 96. Once the desired parameter is found, press the Mode button to view its “contents”. When finished, press Mode to exit the parameter menu. An example is shown herein.

Press **Mode** once

Display reads "00"

Upper right decimal point blinks

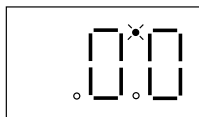

Press **Mode** again

Display reads "P50" (FAULT HISTORY)

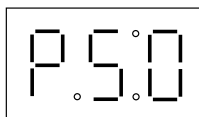

Use ▲ and ▼ to scroll to the desired parameter number

(In this example Parameter 54 has been selected, which is MOTOR LOAD)

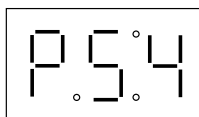

Press **Mode** to view parameter contents (77 = 77% LOAD)

Upper right decimal point blinks

Press **Mode** again to exit

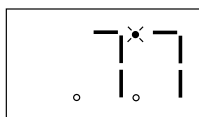

In the example above, Parameter 54 - MOTOR LOAD is being viewed. The “77” in the example indicates that the load on the motor is 77% of the output current rating of the drive.

The following table lists the fault conditions that will cause the drive to shut down, as well as some possible causes. Contact Lenze-AC Tech for more information on troubleshooting faults.

FAULT MESSAGES	
FAULT	DESCRIPTION & POSSIBLE CAUSES
Ad	A/D converter offset error - consult factory.
AF	High Temperature Fault: Ambient temperature is too high; Cooling fan has failed (if equipped).
AL, A1-A4	Assertion level faults. Refer to section B.5 in Appendix B.
bF	Personality Fault: The personality (P94) stored on the EPM does not match the drive model. Refer to Section 13.2.
CF	Control Fault: A blank EPM, or an EPM with corrupted data has been installed. Perform a factory reset using Parameter 48 - PROGRAM SELECTION.
cF	Incompatibility Fault: An EPM with an incompatible parameter version has been installed. Either exchange the EPM, or perform a factory reset (Parameter 48) to change the parameter version of the EPM to match the parameter version of the drive.
dF	Dynamic Braking Fault: The drive has sensed that the dynamic braking resistors are overheating and shuts down to protect the resistors.
EF	External Fault: TB-13A, TB-13C, and/or TB-13D is set as an External Fault input and one of those terminals is open with respect to TB-4. Refer to Parameters 10, 12, and/or 49.
GF	Data Fault: User data and OEM defaults in the EPM are corrupted.
HF	High DC Bus Voltage Fault: Line voltage is too high; Deceleration rate is too fast; Overhauling load. For fast deceleration or overhauling loads, dynamic braking may be required.
IL	Illegal Setup: TB-13A and TB-13D are both set for START FORWARD, or TB-13A is set for RUN REVERSE and TB-13D is set for START FORWARD.
JF	Serial Fault: The watchdog timer has timed out, indicating that the serial link has been lost.
LF	Low DC Bus Voltage Fault: Line voltage is too low.
OF	Output Transistor Fault: Phase to phase or phase to ground short circuit on the output; Failed output transistor; Boost settings are too high; Acceleration rate is too fast.
PF	Current Overload Fault: VFD is undersized for the application; Mechanical problem with the driven equipment.
rF	Flying Restart Fault: Drive was unable to synchronize with the motor during the restart attempt.
SF	Single-phase Fault: Single-phase input power has been applied to a three-phase drive.
UF	Start Fault: Start command was present when the drive was powered up. Must wait 2 seconds after power-up to apply Start command if START METHOD is set to NORMAL.
F1	EPM Fault: The EPM is missing or damaged.
F2 - F9, Fo	Internal Faults: The control board has sensed a problem - consult factory.

To clear a fault issue a STOP command, either on the terminal strip or using the STOP button on the optional remote keypad. The fault will only clear if the condition that caused the fault has passed. For example, if the drive trips on a LOW DC BUS VOLTAGE FAULT (LF) due to low input voltage, the fault cannot be cleared until the input voltage returns to a normal level.

If the drive is programmed to automatically restart after a fault (Parameter 03), the drive will attempt to restart three times after a fault (the drive will not restart after Ad, AL, A1-A4, bF, CF, cF, GF, IL, F1, F2-F9, or Fo faults). If all three restart attempts are unsuccessful, the drive will trip into FAULT LOCKOUT (LC), which requires a manual reset as described above.

17 TCF DISPLAY MESSAGES

The following describes the various displays and messages that can appear on the TCF drive.

17.1 SPEED/TORQUE DISPLAY

If the drive is in a STOP state (indicated by "- -" on the display), and the commanded speed/torque is changed using the keypad (▲ and ▼ buttons), the display will show the commanded speed/torque, and after a few seconds it will begin to alternate between the commanded speed/torque value and "- -". If the **Mode** button is pressed, the display will stop alternating and show "- -" only.

When the drive is given a START command, the displayed speed will start increasing as the drive accelerates up to the commanded speed/torque. If the commanded speed/torque value is changed while the drive is running, the display will show the commanded value while it is being changed, but then it will display the actual speed as the drive ramps up or down to the new commanded value.



NOTE

- When the drive is running in the reverse direction, the upper decimal point on the display will be illuminated.
 - In VECTOR TORQUE mode (refer to Parameter 80), the torque reference display will have the bottom two decimal points illuminated to distinguish it from the actual speed display.
-

17.2 CHANGING THE SPEED REFERENCE SOURCE

When the speed/torque source is changed while the drive is running, the display will flash the message for the new speed/torque source to indicate that the new source is active. Also, if the drive is being controlled from a speed/torque source other than the ▲ and ▼ buttons (0-10 VDC, 4-20 mA, etc), and one of the ▲ or ▼ buttons is pressed, the display will flash the present speed source message to indicate that the ▲ and ▼ buttons are invalid.



NOTE

If the drive is in a STOP state, and the speed reference is changed, the display will not show the message for the new reference source. It will only do so when the drive is running.

Example 1: The drive is running and the present speed source is the keypad. TB-13A is programmed to select a 4-20 mA signal as the speed source. When TB-13A is closed to TB-2, the display will flash “EI” to indicate that the speed source has changed to the 4-20 mA signal. If the contact between TB-13A and TB-2 is opened, the display will flash “CP” to indicate that the speed source has changed back to the ▲ and ▼ buttons.

Example 2: The speed source is a 0-10 VDC signal. If the ▲ or ▼ button is pushed, the display will flash “EU” to indicate that the present speed source is the 0-10 VDC signal and that the ▲ and ▼ buttons are invalid.

Refer to the table below for the possible speed/torque reference source displays:

SPEED SOURCE DISPLAYS		
DISPLAY	DESCRIPTION	
CP / t CP	CONTROL PAD	Speed/torque is set using the s and t buttons on the front of the drive.
EI / t EI	EXTERNAL CURRENT	Speed/torque source is a 4-20 mA signal wired to TB-25 and TB-2.
EU / t EU	EXTERNAL VOLTAGE	Speed/torque source is a 0-10 VDC signal wired to TB-5 and TB-2.
JG	JOG	The drive is in Jog mode, and the speed is set by Preset Speed #2 (Parameter 32).
OP	MOP	(Motor Operated Pot) Contacts wired to TB-13B and TB-13C are used to increase and decrease the drive speed.
Pr1 - Pr7	PRESET SPEEDS #1-7	Speed is set by the indicated Preset Speed (Parameters 31-37).



NOTE

The speed source displays will flash when the speed reference source is changed while the drive is running to indicate that the new speed reference source is active.

17.3 STATUS AND WARNING MESSAGES

STATUS AND WARNING MESSAGES		
DISPLAY	DESCRIPTION	
br	DC BRAKING	The DC braking circuit is activated.
CAL	CALIBRATION	The Auto Calibration function is tuning the drive to the motor.
cE	Change Parameters	"cE" will appear if an attempt is made to change parameters before "translating" the EPM. Refer to Parameter 48 - PROGRAM SELECTION.
CL or FCL	CURRENT LIMIT	The output current has exceeded the CURRENT LIMIT setting (P25) and the drive is reducing the output frequency to reduce the output current. If the drive remains in CURRENT LIMIT for too long, it can trip into a CURRENT OVERLOAD fault (PF).
Er	ERROR	Invalid data has been entered or an invalid command was attempted.
GE	Change OEM	"GE" will be displayed if an attempt is made to change the OEM default settings when the drive is operating in the OEM mode (refer to Parameter 48).
GF	Reset OEM	If "GF" is displayed when a RESET OEM is attempted, it indicates that the OEM defaults in the EPM are corrupted. If "GF" is displayed upon power-up, it indicates that the OEM defaults and the user settings in the EPM are corrupted. Refer to Section 13.1.
GH	Change P94	"GH" will be displayed if an attempt is made to change P94 before changing P85 - P91. Refer to Section 13.2.
LC	FAULT LOCKOUT	The drive has failed three restart attempts and requires a manual reset.
nId	NO MOTOR ID	An attempt was made to start the drive in VECTOR mode without performing the AUTO CALIBRATION (refer to Parameter 81).
SP	START PENDING	"SP" blinks during the interval between restart attempts.
OUR	DECEL OVERRIDE	The drive has stopped decelerating to avoid tripping into an HF fault due to regenerative energy from the motor.

A APPENDIX - VECTOR MODE

A.1 GENERAL

The TCF Series is a sensorless vector drive that can be operated in speed or torque mode, as well as V/Hz mode. Operation in Vector mode results in greater torque (200% starting torque and full torque down to 1 Hz) and more precise speed regulation than V/Hz mode. However, there are cases where Vector mode is not recommended:

1. Multiple motor applications.
2. Where required motor data is not available.
3. Where running in Vector mode causes unstable motor operation.

In these cases, it is recommended that the drive be operated in V/Hz mode or Enhanced V/Hz mode (refer to Parameter 80 - DRIVE MODE).

A.2 CONFIGURING THE TCF FOR VECTOR MODE

1. Connect the drive to the motor according to the diagram in Section 9 - TCF POWER WIRING DIAGRAM.
2. Apply power to the drive.
3. Set Parameter 80 - DRIVE MODE to VECTOR SPEED (05) or VECTOR TORQUE (06), depending on whether it is desired to control speed or torque.
4. Set Parameters 85-88 and 91 according to the motor's nameplate data.
5. Set Parameter 81 - AUTO CALIBRATION to CALIBRATION CYCLE ENABLED (01). The drive's display will alternate between "CAL" and "- - -".
6. Make sure the motor is cold (rotor and windings are at room temperature of 20° to 25° C), and give the drive a START command using one of the Start/ Stop circuits shown in Section 11 - TCF CONTROL WIRING DIAGRAMS. The drive's display should indicate "CAL" for about 40 seconds while the calibration procedure is performed. Once the calibration is done, the display will show "- - -" to indicate that it is stopped. The drive is now ready to be operated. Give the drive another START command to actually start the motor.



NOTE

- If the motor is hot when the AUTO CALIBRATION is performed, the drive will not be able to achieve maximum performance.
 - In VECTOR SPEED or VECTOR TORQUE mode, if an attempt is made to start the drive before performing the AUTO CALIBRATION, the drive will display "nld", and the motor will not operate.
-

A.3 ENHANCED V/Hz MODE

In cases where Vector mode is not appropriate, the TCF Series drive can be operated in Enhanced V/Hz mode to achieve maximum V/Hz performance. Use the following procedure to configure the drive for Enhanced V/Hz mode:

1. Connect the drive to the motor according to the diagram in Section 9 - TCF POWER WIRING DIAGRAM.
2. Apply power to the drive.
3. Set Parameter 80 - DRIVE MODE to ENHANCED CONSTANT V/Hz (03) or ENHANCED VARIABLE V/Hz (04), depending on whether the application is constant torque or variable torque. If the application is a centrifugal fan or pump select ENHANCED VARIABLE V/Hz (04). Otherwise, select ENHANCED CONSTANT V/Hz (03).
4. Set Parameter 86 and 87 according to the motor's nameplate data.
5. Set Parameter 81 - AUTO CALIBRATION to CALIBRATION CYCLE ENABLED (01). The drive's display will alternate between "CAL" and "- - -".
6. Make sure the motor is cold (rotor and windings are at room temperature of 20° to 25° C), and give the drive a START command using one of the Start/ Stop circuits shown in Section 11 - TCF CONTROL WIRING DIAGRAMS. The drive's display should indicate "CAL" for about 40 seconds while the calibration procedure is performed. Once the calibration is done, the display will show "- - -" to indicate that it is stopped. The drive is now ready to be operated. Give the drive another START command to actually start the motor.

B APPENDIX - INPUT ASSERTION LEVEL

B.1 GENERAL

Digital inputs on VFDs are asserted or activated by either applying a voltage level to the input (active-high) or by pulling the input down to a common or ground potential (active-low). This is an important issue when using solid-state outputs (from an external device) to interface with the VFD, but is less of an issue when using dry contacts. Most VFDs are set up for either active-high or active-low, but the TCF can be configured for either type.

The TCF digital inputs (TB-1, 13A, 13B, 13C and 13D) are configured for active-high as standard. Refer to section B.2 to determine if the assertion level must be changed, depending on the type of solid-state circuit being used (PNP/sourcing or NPN/sinking).



NOTE

If dry contacts (from relays, switches, push buttons, etc), or PNP/sourcing circuits are to be used to activate the digital inputs, the assertion level does not need to be changed, and this Appendix can be ignored. Also, the label that covers the control terminal strip can be discarded.

Parameter 79 - INPUT ASSERTION LEVEL shows the assertion level of the inputs, and is either HIGH (01) or LOW (02). This parameter can also be used to change from active-high to active-low during initial set-up using the procedure described below in section B.3.

When set for active-high (P79 set to HIGH), TB-4 is configured as a +12 VDC source and the digital inputs are activated when they are at +10 VDC or higher (24 VDC max) relative to TB-4.

When set for active-low (P79 set to LOW), TB-4 is configured as a 0 VDC common and the digital inputs (which will be at +12 VDC) are activated when they are at +2 VDC or lower relative to TB-4.

B.2 SOLID-STATE CIRCUITS

The digital inputs were designed to work with dry contacts (refer to NOTE above), as well as PNP and NPN type open-collector circuits.

PNP OPEN-COLLECTOR CIRCUITS

If PNP (current-sourcing) outputs are to be used to activate the drive's digital inputs, the assertion level does not need to be changed from the factory default of HIGH.

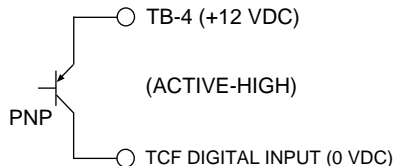

NPN OPEN-COLLECTOR CIRCUITS

If NPN (current-sinking) outputs are to be used to activate the drive's digital inputs, the assertion level must be changed to active-low. Refer to section B.3 for the procedure to change P79 to LOW.

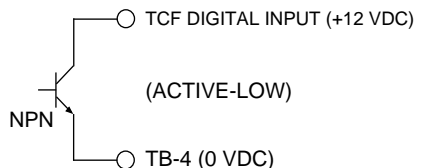

B.3 PROCEDURE FOR CHANGING INPUTS FROM ACTIVE-HIGH TO ACTIVE-LOW

If it is necessary to change the assertion level from active-high to active-low, it can be done via procedure 3.1 'Using the Programming Buttons on the Drive' or 3.2 'Using the EPM Programmer'.



WARNING!

Changing the assertion level of the digital inputs without removing or reconfiguring the control wiring can cause the motor to start unexpectedly, resulting in equipment damage and/or injury to personnel! Be sure to remove all control wiring from the drive's terminal strip prior to changing the assertion level.



NOTE:

Once the following procedure is performed and the inputs are changed to active-low, they cannot be changed back to active-high with this procedure. **DO NOT CHANGE THE ASSERTION LEVEL UNLESS YOU ARE SURE IT IS NECESSARY FOR YOUR SYSTEM!** If the procedure is performed by mistake, and it is necessary to change the assertion level back to active-high, please contact Lenze-AC Tech.

B.3.1 PROCEDURE #1 - USING THE PROGRAMMING BUTTONS ON THE DRIVE

1. Remove all control wiring from the terminal strip of the drive.
2. Enter the programming mode as normal and go to Parameter 79 - INPUT ASSERTION LEVEL.
3. Press **Mode** to display the present setting (should be "01" for active-high).
4. Press the ▲ button. The display will flash "PAS" and then "00", indicating that the special password must be entered first in order to change the setting.
5. Use the ▲ and ▼ buttons to scroll to the password value indicated on the label that covers the drive's control terminal strip, and press **Mode**.
6. The setting of P79 should now indicate "02" for active-low.

B.3.2 PROCEDURE #2 - USING THE EPM PROGRAMMER

1. Remove power from the drive.
2. Remove all control wiring from the terminal strip of the drive.
3. Using the optional EPM Programmer, create a new data file and change Parameter 79 to "02" for active-low (refer to the EPM Programmer manual for more information).
4. Copy the new data file to the drive's EPM.
5. Install the EPM back in the drive.
6. Re-apply power to the drive.
7. The setting of P79 should now indicate "02" for active-low.



NOTE

- The first time an EPM that has been configured with the EPM Programmer is installed in a TCF drive, the assertion level will be changed to match that of the EPM. However, if that EPM is then taken out of the first drive and installed in other drives, it will not change the assertion level (the EPM Programmer would have to be used again to re-program the EPM).
 - Unlike the first procedure (B.3.1), the EPM Programmer can also be used to change the assertion level back to active-high. Simply follow the same procedure above, but set P79 to "01". After following either one of the above procedures, the digital inputs will be configured for active-low, and TB-4 will be at 0 VDC potential. The digital inputs will be at +12 VDC potential. Pulling them low (to +2 VDC or less) will activate the input.
-

B.4 ASSERTION LEVEL AND THE EPM

The TCF drive will store the setting of Parameter 79 - INPUT ASSERTION LEVEL on the EPM (like it does with all of the other parameters), but it will also store this information internally as a safeguard against the assertion level being changed accidentally by swapping EPMs.

The P79 setting stored on the EPM must match the internally stored setting or the drive will trip into an "A1" fault and will not operate. Therefore, if an EPM with a different P79 setting is installed in a drive, the display will show the "A1" fault and the drive will not operate. The only exception to this is if the EPM was just programmed using the EPM Programmer, and it was being installed in a drive for the first time. In this case, the drive's internal assertion level setting will change to match the EPM, as described in NOTE 1 in section B.3.2, and no fault would occur.



WARNING!

Changing the assertion level of the digital inputs without reconfiguring the control wiring can cause the motor to start unexpectedly, resulting in equipment damage and/or injury to personnel! Be sure the control wiring is correct for the selected assertion level.

An "A1" fault can be cleared by one of the following methods:

1. Perform a factory reset of the drive using Parameter 48 - PROGRAM SELECTION. This will change the assertion level setting in the EPM to match the internally stored setting.
2. Power down the drive and install an EPM that has the same assertion level setting as the internal setting.
3. Power down the drive and install an EPM that has just been programmed with the EPM Programmer.
4. Change P79 to match the assertion level on the EPM. If the assertion level is active-low, and needs to be set back to active-high, please contact Lenze-AC Tech.

B.5 DESCRIPTION OF ASSERTION LEVEL FAULTS

Along with the "A1" fault described above, there are a few other faults associated with the drive's assertion level. Refer to the following table.

FAULT	DESCRIPTION, CAUSES & REMEDIES	
AL	Internal AL	Occurs whenever the internal assertion level setting has been changed, regardless of the cause. This fault can be cleared by giving the drive a STOP command.
A1	EPM AL	The assertion level setting stored in the EPM does not match the internally stored setting. Refer to Appendix B, section B.4.
A2	OEM AL stored in EPM	Occurs if the OEM Defaults assertion level stored on the EPM does not match the internally stored setting, and an attempt is made to select setting "02" or "03" in Parameter 48 -PROGRAM SELECTION. This fault can be cleared by giving the drive a Stop command. To prevent this fault, install an EPM with the correct OEM Defaults settings.
A3	Internal AL Corrupt	Occurs if the internally stored assertion level setting is corrupted. In this case, the assertion level will default to active-high (P79 = "01"). This fault can be cleared by performing a reset using Parameter 48 - PROGRAM SELECTION, or by installing an EPM that was just programmed with the desired assertion level using the EPM Programmer (refer to NOTE 1 in Appendix B, section B.3.2).
A4	Control Board Failure	"A4" indicates a failure on the control board. A new control board is required.